

GA-78LMT-USB3

User's Manual

Rev. 6003

12ME-78LTUB3-6003R



For more product details, please visit GIGABYTE's website.



To reduce the impacts on global warming, the packaging materials of this product are recyclable and reusable. GIGABYTE works with you to protect the environment.

Declaration of Conformity

We, Manufacturer/Importer,

G.B.T. Technology Trading GmbH

Address: **Bu**enkoppel 16, 22047 Hamburg, Germany

Declare that the product

Product Type: **Motherboard**

Product Name: **GA-78LMT-USB3**

conforms with the essential requirements of the following directives:

EMC Directive 2004/108/EC (until 2016/04/17), 2014/30/EU (after 2016/04/18):

- | | |
|--|---------------------------|
| <input checked="" type="checkbox"/> Conduction & Radiated Emissions: | EN 55022:2010/AC2011 |
| <input checked="" type="checkbox"/> Immunity: | EN 55024:2010 |
| <input checked="" type="checkbox"/> Power-line harmonics: | EN 61000-3-2:2006+A2:2009 |
| <input checked="" type="checkbox"/> Power-line flicker: | EN 61000-3-3:2013 |

Low Voltage Directive 2006/95/EC (until 2016/04/19), 2014/35/EU (after 2016/04/20):

- | | |
|---|--|
| <input checked="" type="checkbox"/> Safety: | EN60950-1:2006+A11:2009+A12:2011+A2:2013 |
|---|--|

RoHS Directive 2011/65/EU

- | | |
|---|--|
| <input checked="" type="checkbox"/> Restriction of use of certain substances in electronic equipment: | This product does not contain any of the restricted substances listed in Annex II, in concentrations and applications banned by the directive. |
|---|--|

CE marking



Signature: Timmy Huang

(stamp)

Date: Oct. 6, 2014

Name: Timmy Huang

DECLARATION OF CONFORMITY

Per FCC Part 2 Section 2.1077(a)



Responsible Party Name: **G.B.T. INC. (U.S.A.)**

Address: **17358 Railroad Street**

City of Industry, CA 91748

Phone/Fax No: (626) 854-9338/ (626) 854-9326

hereby declares that the product

Product Name: Motherboard

Model Number: GA-78LMT-USB3

Conforms to the following specifications:

FCC Part 15, Subpart B, Section 15.107(a) and Section 15.109 (a), Class B Digital Device

Supplementary Information:

This device complies with part 15 of the FCC Rules. Operation is subject to the following two conditions: (1) This device may not cause harmful and (2) this device must accept any interference received, including that may cause undesired operation.

Representative Person's Name: ERIC LU

Signature: Eric Lu

Date: Oct. 6, 2014

Copyright

© 2016 GIGA-BYTE TECHNOLOGY CO., LTD. All rights reserved.

The trademarks mentioned in this manual are legally registered to their respective owners.

Disclaimer

Information in this manual is protected by copyright laws and is the property of GIGABYTE.

Changes to the specifications and features in this manual may be made by GIGABYTE without prior notice.

No part of this manual may be reproduced, copied, translated, transmitted, or published in any form or by any means without GIGABYTE's prior written permission.

- In order to assist in the use of this product, carefully read the User's Manual.
- For product-related information, check on our website at: <http://www.gigabyte.com>

Identifying Your Motherboard Revision

The revision number on your motherboard looks like this: "REV: X.X." For example, "REV: 1.0" means the revision of the motherboard is 1.0. Check your motherboard revision before updating motherboard BIOS, drivers, or when looking for technical information.

Example:

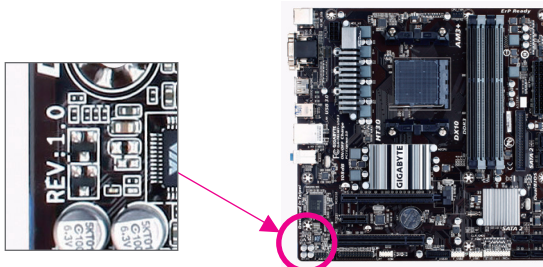
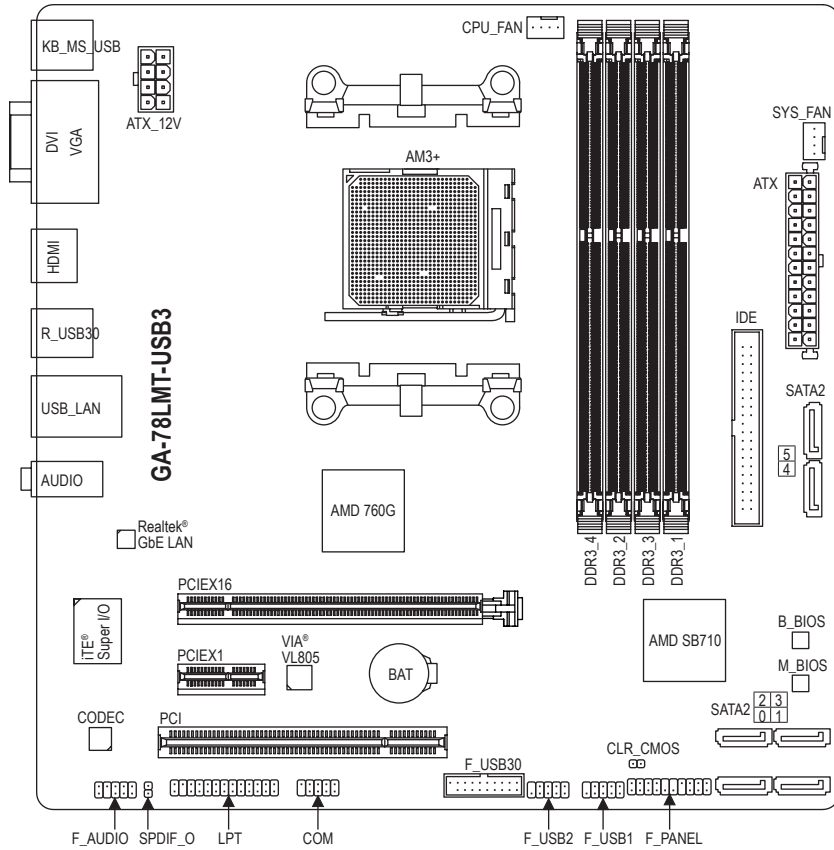

Table of Contents

GA-78LMT-USB3 Motherboard Layout	4
GA-78LMT-USB3 Motherboard Block Diagram	5
Chapter 1 Hardware Installation	6
1-1 Installation Precautions	6
1-2 Product Specifications	7
1-3 Installing the CPU	9
1-4 Installing the Memory	9
1-5 Installing an Expansion Card	10
1-6 Back Panel Connectors	10
1-7 Internal Connectors	12
Chapter 2 BIOS Setup	17
2-1 Startup Screen	18
2-2 MB Intelligent Tweaker(M.I.T.)	19
2-3 Standard CMOS Features	22
2-4 Advanced BIOS Features	23
2-5 Integrated Peripherals	25
2-6 Power Management Setup	27
2-7 PnP/PCI Configurations	28
2-8 PC Health Status	29
2-9 Load Fail-Safe Defaults	30
2-10 Load Optimized Defaults	30
2-11 Set Supervisor/User Password	30
2-12 Save & Exit Setup	30
2-13 Exit Without Saving	30
Chapter 3 Appendix	31
3-1 Drivers Installation	31
3-2 Configuring SATA Hard Drive(s)	31
Regulatory Statements	33
Contact Us	36

GA-78LMT-USB3 Motherboard Layout



Box Contents

- GA-78LMT-USB3 motherboard
- Motherboard driver disk
- User's Manual
- I/O Shield
- Two SATA cables
- One IDE cable

* The box contents above are for reference only and the actual items shall depend on the product package you obtain. The box contents are subject to change without notice.

GA-78LMT-USB3 Motherboard Block Diagram

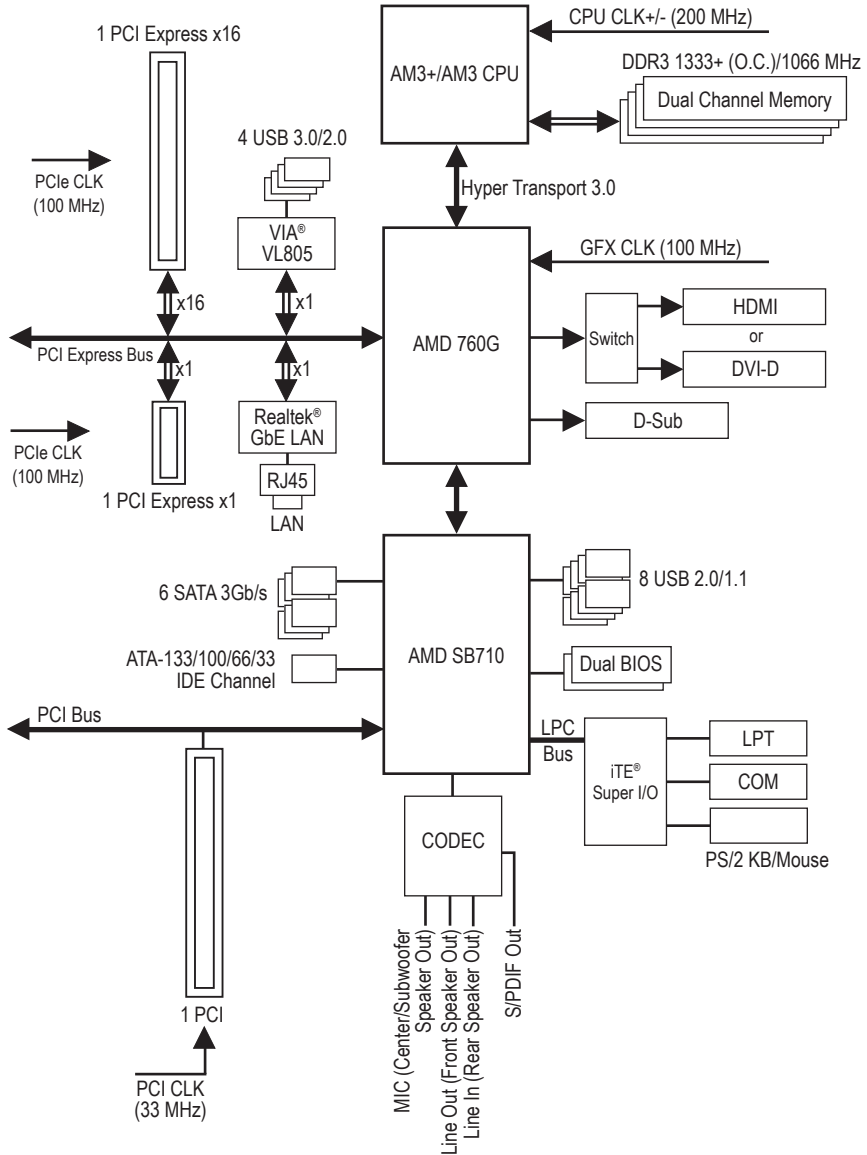

For detailed product information/limitation(s), refer to "1-2 Product Specifications."











Chapter 1 Hardware Installation









1-1 Installation Precautions

The motherboard contains numerous delicate electronic circuits and components which can become damaged as a result of electrostatic discharge (ESD). Prior to installation, carefully read the user's manual and follow these procedures:

- Prior to installation, make sure the chassis is suitable for the motherboard.
- Prior to installation, do not remove or break motherboard S/N (Serial Number) sticker or warranty sticker provided by your dealer. These stickers are required for warranty validation.
- Always remove the AC power by unplugging the power cord from the power outlet before installing or removing the motherboard or other hardware components.
- When connecting hardware components to the internal connectors on the motherboard, make sure they are connected tightly and securely.
- When handling the motherboard, avoid touching any metal leads or connectors.
- It is best to wear an electrostatic discharge (ESD) wrist strap when handling electronic components such as a motherboard, CPU or memory. If you do not have an ESD wrist strap, keep your hands dry and first touch a metal object to eliminate static electricity.
- Prior to installing the motherboard, please have it on top of an antistatic pad or within an electrostatic shielding container.
- Before connecting or unplugging the power supply cable from the motherboard, make sure the power supply has been turned off.
- Before turning on the power, make sure the power supply voltage has been set according to the local voltage standard.
- Before using the product, please verify that all cables and power connectors of your hardware components are connected.
- To prevent damage to the motherboard, do not allow screws to come in contact with the motherboard circuit or its components.
- Make sure there are no leftover screws or metal components placed on the motherboard or within the computer casing.
- Do not place the computer system on an uneven surface.
- Do not place the computer system in a high-temperature or wet environment.
- Turning on the computer power during the installation process can lead to damage to system components as well as physical harm to the user.
- If you are uncertain about any installation steps or have a problem related to the use of the product, please consult a certified computer technician.
- If you use an adapter, extension power cable, or power strip, ensure to consult with its installation and/or grounding instructions.

1-2 Product Specifications

 CPU	<ul style="list-style-type: none"> ◆ AM3+ Socket: <ul style="list-style-type: none"> - AMD AM3+ processor - AMD AM3 Phenom™ II processor/ AMD Athlon™ II processor (Go to GIGABYTE's website for the latest CPU support list.)
 HyperTransport Bus	<ul style="list-style-type: none"> ◆ HyperTransport™ 3.0 ◆ Support for up to 5200 MT/s
 Chipset	<ul style="list-style-type: none"> ◆ North Bridge: AMD 760G ◆ South Bridge: AMD SB710
 Memory	<ul style="list-style-type: none"> ◆ 4 x DDR3 DIMM sockets supporting up to 32 GB of system memory <ul style="list-style-type: none"> * Due to a Windows 32-bit operating system limitation, when more than 4 GB of physical memory is installed, the actual memory size displayed will be less than the size of the physical memory installed. ◆ Dual channel memory architecture ◆ Support for DDR3 1333+ (O.C.)/1066 MHz memory modules (Go to GIGABYTE's website for the latest supported memory speeds and memory modules.)
 Onboard Graphics	<p>North Bridge:</p> <ul style="list-style-type: none"> - 1 x D-Sub port, supporting a maximum resolution of 1920x1200 - 1 x DVI-D port, supporting a maximum resolution of 1920x1200 <ul style="list-style-type: none"> * The DVI-D port does not support D-Sub connection by adapter. - 1 x HDMI port, supporting a maximum resolution of 1920x1200 <ul style="list-style-type: none"> * Simultaneous output for DVI-D and HDMI is not supported. - Support for DirectX 10
 Audio	<ul style="list-style-type: none"> ◆ Realtek® ALC892 codec ◆ High Definition Audio ◆ 2/4/5,1/7.1-channel <ul style="list-style-type: none"> * To configure 7.1-channel audio, you have to use an HD front panel audio module and enable the multi-channel audio feature through the audio driver. ◆ Support for S/PDIF Out
 LAN	<ul style="list-style-type: none"> ◆ Realtek® GbE LAN chip (10/100/1000 Mbit)
 Expansion Slots	<ul style="list-style-type: none"> ◆ 1 x PCI Express x16 slot, running at x16 ◆ 1 x PCI Express x1 slot <p>(All PCI Express slots conform to PCI Express 2.0 standard.)</p> <ul style="list-style-type: none"> ◆ 1 x PCI slot
 Storage Interface	<ul style="list-style-type: none"> ◆ South Bridge: <ul style="list-style-type: none"> - 1 x IDE connector supporting ATA-133/100/66/33 - 6 x SATA 3Gb/s connectors - Support for RAID 0, RAID 1, RAID 10, and JBOD
 USB	<ul style="list-style-type: none"> ◆ Chipset: <ul style="list-style-type: none"> - 8 USB 2.0/1.1 ports (4 ports on the back panel, 4 ports available through the internal USB headers) ◆ VIA® VL805 chip: <ul style="list-style-type: none"> - 4 USB 3.0/2.0 ports (2 ports on the back panel, 2 ports available through the internal USB header)
 Internal Connectors	<ul style="list-style-type: none"> ◆ 1 x 24-pin ATX main power connector ◆ 1 x 8-pin ATX 12V power connector ◆ 6 x SATA 3Gb/s connectors ◆ 1 x IDE connector ◆ 1 x CPU fan header ◆ 1 x system fan header

 Internal Connectors	<ul style="list-style-type: none"> ◆ 1 x front panel header ◆ 1 x front panel audio header ◆ 1 x S/PDIF Out header ◆ 1 x USB 3.0/2.0 header ◆ 2 x USB 2.0/1.1 headers ◆ 1 x serial port header ◆ 1 x parallel port header ◆ 1 x Clear CMOS jumper
 Back Panel Connectors	<ul style="list-style-type: none"> ◆ 1 x PS/2 keyboard/mouse port ◆ 1 x D-Sub port ◆ 1 x DVI-D port ◆ 1 x HDMI port ◆ 2 x USB 3.0/2.0 ports ◆ 4 x USB 2.0/1.1 ports ◆ 1 x RJ-45 port ◆ 3 x audio jacks (Line In, Line Out, Microphone)
 I/O Controller	<ul style="list-style-type: none"> ◆ iTE® I/O Controller Chip
 Hardware Monitor	<ul style="list-style-type: none"> ◆ System voltage detection ◆ CPU/System temperature detection ◆ CPU/System fan speed detection ◆ CPU overheating warning ◆ CPU/System fan fail warning ◆ CPU/System fan speed control <p style="margin-left: 20px;">* Whether the fan speed control function is supported will depend on the cooler you install.</p>
 BIOS	<ul style="list-style-type: none"> ◆ 2 x 32 Mbit flash ◆ Use of licensed AWARD BIOS ◆ Support for DualBIOS™ ◆ PnP 1.0a, DMI 2.0, SM BIOS 2.4, ACPI 1.0b
 Unique Features	<ul style="list-style-type: none"> ◆ Support for @BIOS ◆ Support for Q-Flash ◆ Support for Xpress BIOS Rescue ◆ Support for Download Center ◆ Support for Xpress Install ◆ Support for EasyTune <p style="margin-left: 20px;">* Available functions in EasyTune may differ by motherboard model.</p> <ul style="list-style-type: none"> ◆ Support for Smart Recovery2 ◆ Support for Auto Green ◆ Support for ON/OFF Charge ◆ Support for Q-Share
 Bundled Software	<ul style="list-style-type: none"> ◆ Norton® Internet Security (OEM version)
 Operating System	<ul style="list-style-type: none"> ◆ Support for Windows 7/XP
 Form Factor	<ul style="list-style-type: none"> ◆ Micro ATX Form Factor; 24.4cm x 24.4cm

* GIGABYTE reserves the right to make any changes to the product specifications and product-related information without prior notice.

* Please visit the **Support & Downloads\Utility** page on GIGABYTE's website to check the supported operating system(s) for the software listed in the "Unique Features" and "Bundled Software" columns.

1-3 Installing the CPU



Read the following guidelines before you begin to install the CPU:

- Make sure that the motherboard supports the CPU.
(Go to GIGABYTE's website for the latest CPU support list.)
- Always turn off the computer and unplug the power cord from the power outlet before installing the CPU to prevent hardware damage.
- Locate the pin one of the CPU. The CPU cannot be inserted if oriented incorrectly.
- Apply an even and thin layer of thermal grease on the surface of the CPU.
- Do not turn on the computer if the CPU cooler is not installed, otherwise overheating and damage of the CPU may occur.
- Set the CPU host frequency in accordance with the CPU specifications. It is not recommended that the system bus frequency be set beyond hardware specifications since it does not meet the standard requirements for the peripherals. If you wish to set the frequency beyond the standard specifications, please do so according to your hardware specifications including the CPU, graphics card, memory, hard drive, etc.

Installing the CPU

Locate the pin one (denoted by a small triangle) of the CPU socket and the CPU.

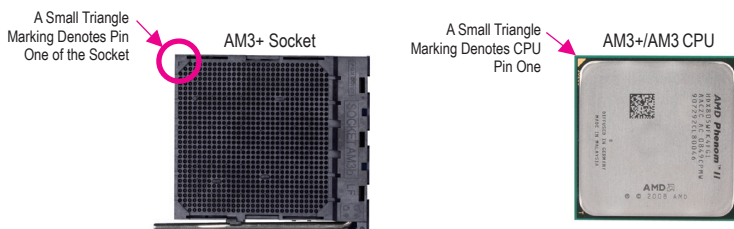

1-4 Installing the Memory



Read the following guidelines before you begin to install the memory:

- Make sure that the motherboard supports the memory. It is recommended that memory of the same capacity, brand, speed, and chips be used.
(Go to GIGABYTE's website for the latest supported memory speeds and memory modules.)
- Always turn off the computer and unplug the power cord from the power outlet before installing the memory to prevent hardware damage.
- Memory modules have a foolproof design. A memory module can be installed in only one direction. If you are unable to insert the memory, switch the direction.

Dual Channel Memory Configuration

This motherboard provides four DDR3 memory sockets and supports Dual Channel Technology. After the memory is installed, the BIOS will automatically detect the specifications and capacity of the memory. Enabling Dual Channel memory mode will double the original memory bandwidth.

The four DDR3 memory sockets are divided into two channels and each channel has two memory sockets as following:

▶▶ Channel 0: DDR3_2, DDR3_4

▶▶ Channel 1: DDR3_1, DDR3_3

▶▶ Dual Channel Memory Configurations Table

	DDR3_4	DDR3_2	DDR3_3	DDR3_1
Two Modules	--	DS/SS	--	DS/SS
	DS/SS	--	DS/SS	--
4 Modules	DS/SS	DS/SS	DS/SS	DS/SS

(SS=Single-Sided, DS=Double-Sided, "--=No Memory)

Due to CPU limitations, read the following guidelines before installing the memory in Dual Channel mode.

1. Dual Channel mode cannot be enabled if only one DDR3 memory module is installed.
2. When enabling Dual Channel mode with two or four memory modules, it is recommended that memory of the same capacity, brand, speed, and chips be used and installed in the same colored DDR3 sockets for optimum performance.

1-5 Installing an Expansion Card



Read the following guidelines before you begin to install an expansion card:

- Make sure the motherboard supports the expansion card. Carefully read the manual that came with your expansion card.
- Always turn off the computer and unplug the power cord from the power outlet before installing an expansion card to prevent hardware damage.

1-6 Back Panel Connectors

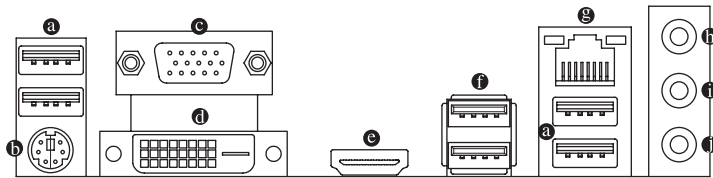

(a) USB 2.0/1.1 Port

The USB port supports the USB 2.0/1.1 specification. Use this port for USB devices such as a USB keyboard/mouse, USB printer, USB flash drive and etc.

(b) PS/2 Keyboard/Mouse Port

Use this port to connect a PS/2 mouse or keyboard.

(c) D-Sub Port

The D-Sub port supports a 15-pin D-Sub connector and supports a maximum resolution of 1920x1200 (the actual resolutions supported depend on the monitor being used). Connect a monitor that supports D-Sub connection to this port.

(d) DVI-D Port (Note 1)

The DVI-D port conforms to the DVI-D specification and supports a maximum resolution of 1920x1200 (the actual resolutions supported depend on the monitor being used). Connect a monitor that supports DVI-D connection to this port.

(e) HDMI Port (Note 2)

HDMI™ The HDMI (High-Definition Multimedia Interface) provides an all-digital audio/video interface to transmit the uncompressed audio/video signals and is HDCP compliant. Connect the HDMI audio/video device to this port. The HDMI Technology can support a maximum resolution of 1920x1200 but the actual resolutions supported depend on the monitor being used.



- After installing the HDMI device, make sure to set the default sound playback device to HDMI. (The item name may differ depending on your operating system.)
- Please note the HDMI audio output only supports AC3, DTS and 2-channel-LPCM formats. (AC3 and DTS require the use of an external decoder for decoding.)

(Note 1) The DVI-D port does not support D-Sub connection by adapter.

(Note 2) Simultaneous output for DVI-D and HDMI is not supported.



- When removing the cable connected to a back panel connector, first remove the cable from your device and then remove it from the motherboard.
- When removing the cable, pull it straight out from the connector. Do not rock it side to side to prevent an electrical short inside the cable connector.

A. Dual Display Configurations:

This motherboard provides three video output ports. The table below shows the supported dual display configurations.

Dual Display	Combination	Supported or Not
	D-Sub + DVI-D	Yes
	D-Sub + HDMI	Yes
	DVI-D + HDMI	No

B. Playback of Blu-ray™ Discs:

In order to get better playback quality, when playing the Blu-ray™ discs, refer to the recommended system requirements (or better) below.

- Memory: Two 1 GB DDR3 1066 MHz memory modules with dual channel mode enabled
- BIOS Setup: At least 256 MB of UMA Frame Buffer Size (refer to Chapter 2, "BIOS Setup," "Advanced BIOS Features," for more information)
- Playback software: CyberLink PowerDVD 10.0 or later (Note: Please ensure Hardware Acceleration is enabled.)
- HDCP compliant monitor(s)

① USB 3.0/2.0 Port

The USB 3.0 port supports the USB 3.0 specification and is compatible to the USB 2.0/1.1 specification. Use this port for USB devices Use this port for USB devices such as a USB keyboard/mouse, USB printer, USB flash drive and etc.

② RJ-45 LAN Port

The Gigabit Ethernet LAN port provides Internet connection at up to 1 Gbps data rate. The following describes the states of the LAN port LEDs.

Connection/ Speed LED	Activity LED	Connection/Speed LED:		Activity LED:	
		State	Description	State	Description
		Orange	1 Gbps data rate	Blinking	Data transmission or receiving is occurring
		Green	100 Mbps data rate	Off	No data transmission or receiving is occurring
		Off	10 Mbps data rate		

③ Line In Jack (Blue)

The line in jack. Use this audio jack for line in devices such as an optical drive, walkman, etc.

④ Line Out Jack (Green)

The line out jack. Use this audio jack for a headphone or 2-channel speaker. This jack can be used to connect front speakers in a 4/5.1/7.1-channel audio configuration.

⑤ Mic In Jack (Pink)

The Mic in jack. Microphones must be connected to this jack.



To configure 7.1-channel audio, you have to use an HD front panel audio module and enable the multi-channel audio feature through the audio driver.

1-7 Internal Connectors

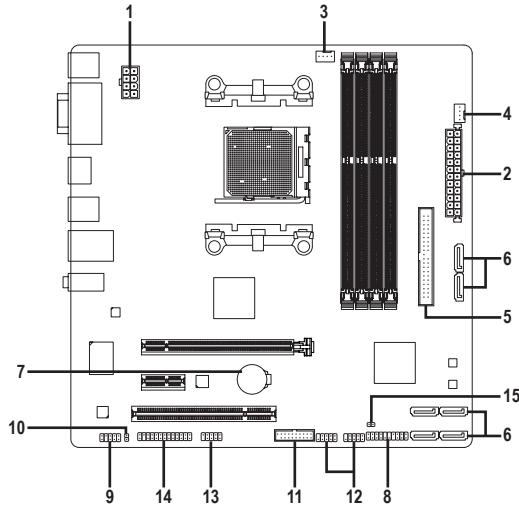

1) ATX_12V	9) F_AUDIO
2) ATX	10) SPDIF_O
3) CPU_FAN	11) F_USB30
4) SYS_FAN	12) F_USB1/F_USB2
5) IDE	13) COM
6) SATA2 0/1/2/3/4/5	14) LPT
7) BAT	15) CLR_CMOS
8) F_PANEL	



Read the following guidelines before connecting external devices:

- First make sure your devices are compliant with the connectors you wish to connect.
- Before installing the devices, be sure to turn off the devices and your computer. Unplug the power cord from the power outlet to prevent damage to the devices.
- After installing the device and before turning on the computer, make sure the device cable has been securely attached to the connector on the motherboard.

1/2) ATX_12V/ATX (2x4 12V Power Connector and 2x12 Main Power Connector)

With the use of the power connector, the power supply can supply enough stable power to all the components on the motherboard. Before connecting the power connector, first make sure the power supply is turned off and all devices are properly installed. The power connector possesses a foolproof design. Connect the power supply cable to the power connector in the correct orientation.

The 12V power connector mainly supplies power to the CPU. If the 12V power connector is not connected, the computer will not start.



To meet expansion requirements, it is recommended that a power supply that can withstand high power consumption be used (500W or greater). If a power supply is used that does not provide the required power, the result can lead to an unstable or unbootable system.

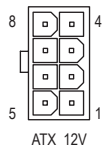

ATX_12V:

Pin No.	Definition	Pin No.	Definition
1	GND (Only for 2x4-pin 12V)	5	+12V (Only for 2x4-pin 12V)
2	GND (Only for 2x4-pin 12V)	6	+12V (Only for 2x4-pin 12V)
3	GND	7	+12V
4	GND	8	+12V

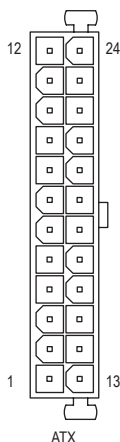

ATX:

Pin No.	Definition	Pin No.	Definition
1	3.3V	13	3.3V
2	3.3V	14	-12V
3	GND	15	GND
4	+5V	16	PS_ON (soft On/Off)
5	GND	17	GND
6	+5V	18	GND
7	GND	19	GND
8	Power Good	20	NC
9	5VSB (stand by +5V)	21	+5V
10	+12V	22	+5V
11	+12V (Only for 2x12-pin ATX)	23	+5V (Only for 2x12-pin ATX)
12	3.3V (Only for 2x12-pin ATX)	24	GND (Only for 2x12-pin ATX)

3/4) CPU_FAN/SYS_FAN (Fan Headers)

All fan headers on this motherboard are 4-pin. Most fan headers possess a foolproof insertion design. When connecting a fan cable, be sure to connect it in the correct orientation (the black connector wire is the ground wire). The speed control function requires the use of a fan with fan speed control design. For optimum heat dissipation, it is recommended that a system fan be installed inside the chassis.



CPU_FAN/SYS_FAN:

Pin No.	Definition
1	GND
2	+12V
3	Sense
4	Speed Control



- Be sure to connect fan cables to the fan headers to prevent your CPU and system from overheating. Overheating may result in damage to the CPU or the system may hang.
- These fan headers are not configuration jumper blocks. Do not place a jumper cap on the headers.

5) IDE (IDE Connector)

The IDE connector supports up to two IDE devices such as hard drives and optical drives. Before attaching the IDE cable, locate the foolproof groove on the connector. If you wish to connect two IDE devices, remember to set the jumpers and the cabling according to the role of the IDE devices (for example, master or slave). (For information about configuring master/slave settings for the IDE devices, read the instructions from the device manufacturers.)

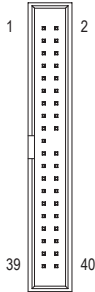

6) SATA2 0/1/2/3/4/5 (SATA 3Gb/s Connectors)

The SATA connectors conform to SATA 3Gb/s standard and are compatible with SATA 1.5Gb/s standard. Each SATA connector supports a single SATA device. The AMD controller supports RAID 0, RAID 1, RAID 10, and JBOD. Refer to Chapter 4, "Configuring SATA Hard Drive(s)," for instructions on configuring a RAID array.

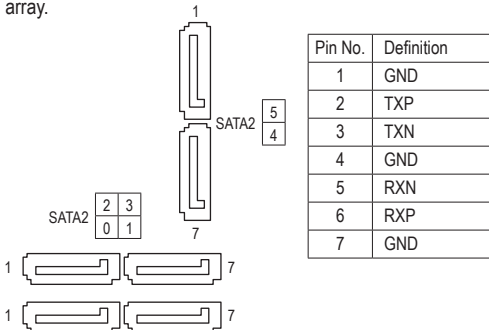

- A RAID 0 or RAID 1 configuration requires at least two hard drives. If more than two hard drives are to be used, the total number of hard drives must be an even number.
- A RAID 10 configuration requires four hard drives.
- To enable hot-plugging for the SATA ports, refer to Chapter 2, "BIOS Setup," "Integrated Peripherals\OnChip SATA Port as ESP," for more information.

7) BAT (Battery)

The battery provides power to keep the values (such as BIOS configurations, date, and time information) in the CMOS when the computer is turned off. Replace the battery when the battery voltage drops to a low level, or the CMOS values may not be accurate or may be lost.

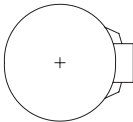

You may clear the CMOS values by removing the battery:

1. Turn off your computer and unplug the power cord.
2. Gently remove the battery from the battery holder and wait for one minute. (Or use a metal object like a screwdriver to touch the positive and negative terminals of the battery holder, making them short for 5 seconds.)
3. Replace the battery.
4. Plug in the power cord and restart your computer.



- Always turn off your computer and unplug the power cord before replacing the battery.
- Replace the battery with an equivalent one. Danger of explosion if the battery is replaced with an incorrect model.
- Contact the place of purchase or local dealer if you are not able to replace the battery by yourself or uncertain about the battery model.
- When installing the battery, note the orientation of the positive side (+) and the negative side (-) of the battery (the positive side should face up).
- Used batteries must be handled in accordance with local environmental regulations.

8) F_PANEL (Front Panel Header)

Connect the power switch, reset switch, speaker, chassis intrusion switch/sensor and system status indicator on the chassis to this header according to the pin assignments below. Note the positive and negative pins before connecting the cables.

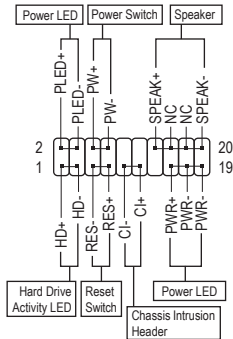

- HD (Hard Drive Activity LED):**
 Connects to the hard drive activity LED on the chassis front panel. The LED is on when the hard drive is reading or writing data.
- RES (Reset Switch):**
 Connects to the reset switch on the chassis front panel. Press the reset switch to restart the computer if the computer freezes and fails to perform a normal restart.
- CI (Chassis Intrusion Header):**
 Connects to the chassis intrusion switch/sensor on the chassis that can detect if the chassis cover has been removed. This function requires a chassis with a chassis intrusion switch/sensor.
- NC:** No connection.



The front panel design may differ by chassis. A front panel module mainly consists of power switch, reset switch, power LED, hard drive activity LED, speaker and etc. When connecting your chassis front panel module to this header, make sure the wire assignments and the pin assignments are matched correctly.

- PLED/PWR_LED (Power LED):**

System Status	LED
S0	On
S1	Blinking
S3/S4/S5	Off

Connects to the power status indicator on the chassis front panel. The LED is on when the system is operating. The LED keeps blinking when the system is in S1 sleep state. The LED is off when the system is in S3/S4 sleep state or powered off (S5).

- PW (Power Switch):**

Connects to the power switch on the chassis front panel. You may configure the way to turn off your system using the power switch (refer to Chapter 2, "BIOS Setup," "Power Management," for more information).

- SPEAK (Speaker):**

Connects to the speaker on the chassis front panel. The system reports system startup status by issuing a beep code. One single short beep will be heard if no problem is detected at system startup. If a problem is detected, the BIOS may issue beeps in different patterns to indicate the problem.

9) F_AUDIO (Front Panel Audio Header)

The front panel audio header supports Intel High Definition audio (HD) and AC'97 audio. You may connect your chassis front panel audio module to this header. Make sure the wire assignments of the module connector match the pin assignments of the motherboard header. Incorrect connection between the module connector and the motherboard header will make the device unable to work or even damage it.



For HD Front Panel Audio:

Pin No.	Definition
1	MIC2_L
2	GND
3	MIC2_R
4	-ACZ_DET
5	LINE2_R
6	Sense
7	FAUDIO_JD
8	No Pin
9	LINE2_L
10	Sense

For AC'97 Front Panel Audio:

Pin No.	Definition
1	MIC
2	GND
3	MIC Power
4	NC
5	Line Out (R)
6	NC
7	NC
8	No Pin
9	Line Out (L)
10	NC



- The front panel audio header supports HD audio by default.
- Audio signals will be present on both of the front and back panel audio connections simultaneously.
- Some chassis provide a front panel audio module that has separated connectors on each wire instead of a single plug. For information about connecting the front panel audio module that has different wire assignments, please contact the chassis manufacturer.

10) SPDIF_O (S/PDIF Out Header)

This header supports digital S/PDIF Out and connects a S/PDIF digital audio cable (provided by expansion cards) for digital audio output from your motherboard to certain expansion cards like graphics cards and sound cards. For example, some graphics cards may require you to use a S/PDIF digital audio cable for digital audio output from your motherboard to your graphics card if you wish to connect an HDMI display to the graphics card and have digital audio output from the HDMI display at the same time. For information about connecting the S/PDIF digital audio cable, carefully read the manual for your expansion card.



Pin No.	Definition
1	SPDIFO
2	GND

11) F_USB30 (USB 3.0/2.0 Header)

The header conforms to USB 3.0/2.0 specification and can provide two USB ports. For purchasing the optional 3.5" front panel that provides two USB 3.0/2.0 ports, please contact the local dealer.

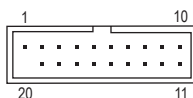

Pin No.	Definition	Pin No.	Definition	Pin No.	Definition
1	VBUS	8	D1-	15	SSTX2-
2	SSRX1-	9	D1+	16	GND
3	SSRX1+	10	NC	17	SSRX2+
4	GND	11	D2+	18	SSRX2-
5	SSTX1-	12	D2-	19	VBUS
6	SSTX1+	13	GND	20	No Pin
7	GND	14	SSTX2+		

12) F_USB1/F_USB2 (USB 2.0/1.1 Headers)

The headers conform to USB 2.0/1.1 specification. Each USB header can provide two USB ports via an optional USB bracket. For purchasing the optional USB bracket, please contact the local dealer.



Pin No.	Definition	Pin No.	Definition
1	Power (5V)	6	USB DY+
2	Power (5V)	7	GND
3	USB DX-	8	GND
4	USB DY-	9	No Pin
5	USB DX+	10	NC



- Do not plug the IEEE 1394 bracket (2x5-pin) cable into the USB header.
- Prior to installing the USB bracket, be sure to turn off your computer and unplug the power cord from the power outlet to prevent damage to the USB bracket.

13) COM (Serial Port Header)

The COM header can provide one serial port via an optional COM port cable. For purchasing the optional COM port cable, please contact the local dealer.



Pin No.	Definition	Pin No.	Definition
1	ND CD-	6	NDSR-
2	NSIN	7	NRTS-
3	NSOUT	8	NCTS-
4	NDTR-	9	NRI-
5	GND	10	No Pin

14) LPT (Parallel Port Header)

The LPT header can provide one parallel port via an optional LPT port cable. For purchasing the optional LPT port cable, please contact the local dealer.

Pin No.	Definition	Pin No.	Definition	Pin No.	Definition
1	STB-	10	GND	19	ACK-
2	AFD-	11	PD4	20	GND
3	PD0	12	GND	21	BUSY
4	ERR-	13	PD5	22	GND
5	PD1	14	GND	23	PE
6	INIT-	15	PD6	24	No Pin
7	PD2	16	GND	25	SLCT
8	SLIN-	17	PD7	26	GND
9	PD3	18	GND		



15) CLR_CMOS (Clear CMOS Jumper)

Use this jumper to clear the BIOS configuration and reset the CMOS values to factory defaults. To clear the CMOS values, use a metal object like a screwdriver to touch the two pins for a few seconds.



Open: Normal



Short: Clear CMOS Values



- Always turn off your computer and unplug the power cord from the power outlet before clearing the CMOS values.
- After system restart, go to BIOS Setup to load factory defaults (select Load Optimized Defaults) or manually configure the BIOS settings (refer to Chapter 2, "BIOS Setup," for BIOS configurations).

Chapter 2 BIOS Setup

BIOS (Basic Input and Output System) records hardware parameters of the system in the CMOS on the motherboard. Its major functions include conducting the Power-On Self-Test (POST) during system startup, saving system parameters and loading operating system, etc. BIOS includes a BIOS Setup program that allows the user to modify basic system configuration settings or to activate certain system features.

When the power is turned off, the battery on the motherboard supplies the necessary power to the CMOS to keep the configuration values in the CMOS.

To access the BIOS Setup program, press the <Delete> key during the POST when the power is turned on.

To upgrade the BIOS, use either the GIGABYTE Q-Flash or @BIOS utility.

- Q-Flash allows the user to quickly and easily upgrade or back up BIOS without entering the operating system.
- @BIOS is a Windows-based utility that searches and downloads the latest version of BIOS from the Internet and updates the BIOS.



- Because BIOS flashing is potentially risky, if you do not encounter problems using the current version of BIOS, it is recommended that you not flash the BIOS. To flash the BIOS, do it with caution. Inadequate BIOS flashing may result in system malfunction.
- It is recommended that you not alter the default settings (unless you need to) to prevent system instability or other unexpected results. Inadequately altering the settings may result in system's failure to boot. If this occurs, try to clear the CMOS values and reset the board to default values. (Refer to the "Load Optimized Defaults" section in this chapter or introductions of the battery/clear CMOS jumper in Chapter 1 for how to clear the CMOS values.)

2-1 Startup Screen

The following screen will appear when the computer boots.
(Sample BIOS Version: F1d)

The POST Screen

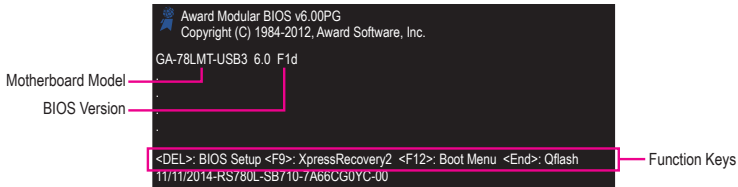

On the main menu of the BIOS Setup program, press arrow keys to move among the items and press <Enter> to accept or enter a sub-menu. Or you can use your mouse to select the item you want.



- If you do not find the settings you want in the Main Menu or a submenu, press <Ctrl>+<F1> to access more advanced options.
- When the system is not stable as usual, select the **Load Optimized Defaults** item to set your system to its defaults.
- The BIOS Setup menus described in this chapter are for reference only and may differ by BIOS version.

■ The Functions of the <F11> and <F12> keys (For the Main Menu Only)

▶ F11: Save CMOS to BIOS

This function allows you to save the current BIOS settings to a profile. You can create up to 8 profiles (Profile 1-8) and name each profile. First enter the profile name (to erase the default profile name, use the SPACE key) and then press <Enter> to complete.

▶ F12: Load CMOS from BIOS

If your system becomes unstable and you have loaded the BIOS default settings, you can use this function to load the BIOS settings from a profile created before, without the hassles of reconfiguring the BIOS settings. First select the profile you wish to load and then press <Enter> to complete.

2-2 MB Intelligent Tweaker(M.I.T.)

CMOS Setup Utility-Copyright (C) 1984-2012 Award Software
MB Intelligent Tweaker(M.I.T.)

			Item Help
▶	IGX Configuration	[Press Enter]	
	CPU Clock Ratio	[Auto]	3000Mhz
	CPU NorthBridge Freq.	[Auto]	2000Mhz
	Core Performance Boost ^(Note)	[Enabled]	
	CPB Ratio ^(Note)	[Auto]	3100Mhz
	Turbo CPB ^(Note)	[Disabled]	
	CPU Host Clock Control	[Auto]	
x	CPU Frequency(MHz)		200
	PCIe Clock(MHz)	[Auto]	
	HT Link Width	[Auto]	
	HT Link Frequency	[Auto]	2000Mhz
	Set Memory Clock	[Auto]	
x	Memory Clock		x6.66 1333Mhz
▶	DRAM Configuration	[Press Enter]	
***** System Voltage Optimized *****			
	System Voltage Control	[Auto]	
x	NorthBridge Volt Control	Auto	
x	DDR3 Voltage	Auto	
x	CPU Voltage Control	Auto	
x	CPU NB VID Control	Auto	
	Normal CPU Vcore		1.4250V
	Normal CPU Vcore NB		1.1750V

↑↓→←: Move Enter: Select +/-/PU/PD: Value F10: Save ESC: Exit F1: General Help
F5: Previous Values F6: Fail-Safe Defaults F7: Optimized Defaults



Whether the system will work stably with the overclock/overvoltage settings you made is dependent on your overall system configurations. Incorrectly doing overclock/overvoltage may result in damage to CPU, chipset, or memory and reduce the useful life of these components. This page is for advanced users only and we recommend you not to alter the default settings to prevent system instability or other unexpected results. (Inadequately altering the settings may result in system's failure to boot. If this occurs, clear the CMOS values and reset the board to default values.)

▶ IGX Configuration

☞ Internal Graphics Mode

Allows you to determine whether to allocate system memory for the onboard graphics controller.

- ▶ Disabled Disables the onboard graphics controller.
- ▶ UMA Allocates memory for the onboard graphics controller from the system memory. (Default)

☞ UMA Frame Buffer Size

Frame buffer size is the total amount of system memory allocated solely for the onboard graphics controller. MS-DOS, for example, will use only this memory for display. Options are: Auto (default), 128MB, 256MB, 512MB, 1024MB.

☞ Surround View

Enables or disables the Surround View function. This option is configurable only when **Init Display First** under **Advanced BIOS Features** is set to **PEG** and an AMD graphics card is installed. (Default: Disabled)

☞ Onboard VGA output connect

Specifies the graphics display of the onboard graphics output from the D-SUB/DVI-D or D-SUB/HDMI.

- ▶ Auto BIOS automatically determines the primary display port for output, depending on to which port the display device is connected, D-SUB/DVI-D or D-SUB/HDMI. (Default)
- ▶ D-SUB/DVI Sets the D-SUB/DVI-D as the graphics display.
- ▶ D-SUB/HDMI Sets the D-SUB/HDMI as the graphics display.

☞ VGA Core Clock control

Allows you to determine whether to manually set the VGA Core clock. (Default: Auto)

(Note) This item is present only when you install a CPU that supports this feature.

- ☞ **VGA Core Clock(MHz)**
 Allows you to set the onboard graphics clock. The adjustable range is from 200 MHz to 2000 MHz. This item is configurable only if the **VGA Core Clock control** option is set to **Manual**.
- ☞ **CPU Clock Ratio**
 Allows you to alter the clock ratio for the installed CPU. The adjustable range is dependent on the CPU being installed.
- ☞ **CPU NorthBridge Freq.**
 Allows you to alter the North Bridge controller frequency for the installed CPU. The adjustable range is dependent on the CPU being installed.
- ☞ **Core Performance Boost ^(Note)**
 Allows you to determine whether to enable the Core Performance Boost (CPB) technology, a CPU performance-boost technology. (Default: Enabled)
- ☞ **CPB Ratio ^(Note)**
 Allows you alter the ratio for the CPB. The adjustable range is dependent on the CPU being installed. (Default: Auto)
- ☞ **Turbo CPB ^(Note)**
 Allows you to determine whether to improve CPU performance. (Default: Disabled)
- ☞ **CPU Host Clock Control**
 Enables or disables the control of CPU host clock. **Auto** (default) allows the BIOS to automatically adjust the CPU host frequency. **Manual** allows the **CPU Frequency (MHz)** item below to be configurable. Note: If your system fails to boot after overclocking, please wait for 20 seconds to allow for automated system reboot, or clear the CMOS values to reset the board to default values. (Default: Auto)
- ☞ **CPU Frequency(MHz)**
 Allows you to manually set the CPU host frequency. The adjustable range is from 200 MHz to 500 MHz. This option is configurable only when **CPU Host Clock Control** is set to **Manual**.
Important: It is highly recommended that the CPU frequency be set in accordance with the CPU specifications.
- ☞ **PCIe Clock(MHz)**
 Allows you to manually set the PCIe clock frequency. The adjustable range is from 100 MHz to 150 MHz. **Auto** sets the PCIe clock frequency to standard 100 MHz. (Default: Auto)
- ☞ **HT Link Width**
 Allows you to manually set the width for the HT Link between the CPU and chipset.

 - ▶▶ Auto BIOS will automatically adjust the HT Link Width. (Default)
 - ▶▶ 8 bit Sets HT Link Width to 8 bit.
 - ▶▶ 16 bit Sets HT Link Width to 16 bit.
- ☞ **HT Link Frequency**
 Allows you to manually set the frequency for the HT Link between the CPU and chipset.

 - ▶▶ Auto BIOS will automatically adjust the HT Link Frequency. (Default)
 - ▶▶ x1~x10 Sets HT Link Frequency to x1~x10 (200 MHz~2.0 GHz).
- ☞ **Set Memory Clock**
 Determines whether to manually set the memory clock. **Auto** lets BIOS automatically set the memory clock as required. **Manual** allows the memory clock control item below to be configurable. (Default: Auto)
- ☞ **Memory Clock**
 This option is configurable only when **Set Memory Clock** is set to **Manual**. Options are: X4.00, X5.33, X6.66, X8.00.

(Note) This item is present only when you install a CPU that supports this feature.

▶ DRAM Configuration

☞ DCTs Mode

Allows you to set memory control mode.

- ▶ Ganged Sets memory control mode to single dual-channel.
- ▶ Unganged Sets memory control mode to two single-channel. (Default)

☞ DDR3 Timing Items

Manual allows all DRAM timing control items below to be configurable.

Options are: Auto (default), Manual.

☞ 1T/2T Command Timing

Options are: Auto (default), 1T, 2T.

☞ CAS# latency

Options are: Auto (default), 4T~12T.

☞ RAS to CAS R/W Delay

Options are: Auto (default), 5T~12T.

☞ Row Precharge Time

Options are: Auto (default), 5T~12T.

☞ Minimum RAS Active Time

Options are: Auto (default), 15T~30T.

☞ TwTr Command Delay

Options are: Auto (default), 4T~7T.

☞ Trfc0 for DIMM1, DIMM3

Options are: Auto (default), 90ns, 110ns, 160ns, 300ns, 350ns.

☞ Trfc1 for DIMM2, DIMM4

Options are: Auto (default), 90ns, 110ns, 160ns, 300ns, 350ns.

☞ Write Recovery Time

Options are: Auto (default), 5T~8T, 10T, 12T.

☞ Precharge Time

Options are: Auto (default), 4T~7T.

☞ Row Cycle Time

Options are: Auto (default), 11T~42T.

☞ RAS to RAS Delay

Options are: Auto (default), 4T~7T.

☞ Channel Interleaving

Enables or disables memory channel interleaving. **Enabled** allows the system to simultaneously access different channels of the memory to increase memory performance and stability. (Default: Enabled)

☞ Bank Interleaving

Enables or disables memory bank interleaving. **Enabled** allows the system to simultaneously access different ranks of the memory to increase memory performance and stability. (Default: Enabled)

☞ DQS Training Control

Enables or disables memory DQS training each time the system restarts. (Default: Skip DQS)

☞ Memclock tri-stating

Determines whether to enable memory clock tri-stating in CPU C3 or Alt VID mode. (Default: Disabled)

***** System Voltage Optimized *****

System Voltage Control

Determines whether to manually set the system voltages. **Auto** lets the BIOS automatically set the system voltages as required. **Manual** allows all voltage control items below to be configurable. (Default: Auto)

NorthBridge Volt Control

Allows you to set the North Bridge voltage.

- ▶ Normal Supplies the North Bridge voltage as required. (Default)
- ▶ +0.1V ~ +0.3V The adjustable range is from 0.1V to 0.3V.

DDR3 Voltage

Allows you to set memory voltage.

- ▶ Normal Supplies the memory voltage as required. (Default)
- ▶ 1.500V ~ 1.900V The adjustable range is from 1.500V to 1.900V.

Note: Increasing memory voltage may result in damage to the memory or reduce the useful life of the memory.

CPU Voltage Control

Allows you to set the CPU voltage. **Auto** sets the CPU voltage as required. The adjustable range is dependent on the CPU being installed. (Default: Normal)

Note: Increasing CPU voltage may result in damage to your CPU or reduce the useful life of the CPU.

CPU NB VID Control

Allows you to set the CPU North Bridge VID voltage. **Auto** sets the CPU North Bridge VID voltage as required. The adjustable range is dependent on the CPU being installed. (Default: Normal)

Note: Increasing CPU voltage may result in damage to your CPU or reduce the useful life of the CPU.

Normal CPU Vcore

Displays the normal operating voltage of your CPU.

Normal CPU Vcore NB

Displays the normal operating voltage of your CPU North Bridge.

2-3 Standard CMOS Features

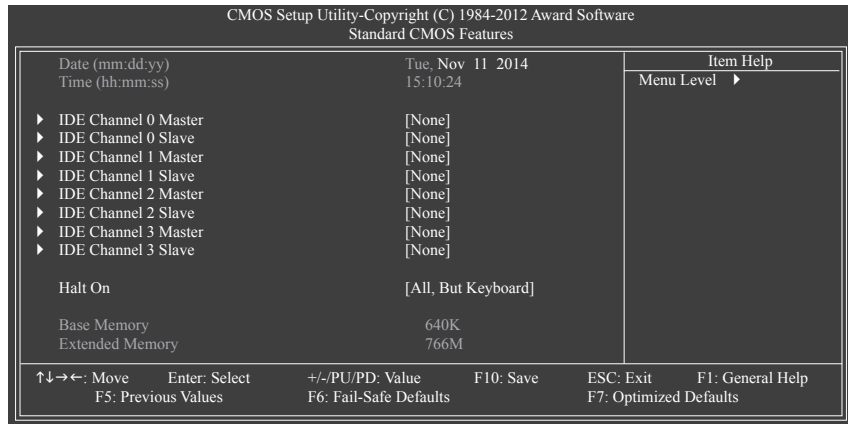

Date (mm:dd:yy)

Sets the system date.

Time (hh:mm:ss)

Sets the system time.

☞ IDE Channel 0, 1, 2, 3 Master/Slave

☛ IDE Channel 0, 1 Master/Slave; Extended IDE Drive

Options are:

- None If no IDE/SATA devices are used, set this item to **None** so the system will skip the detection of the device during the POST for faster system startup.
 - Auto Lets the BIOS automatically detect IDE/SATA devices during the POST. (Default)
 - Manual Allows you to manually enter the specifications of the hard drive when the hard drive access mode is set to **CHS**.
- ☛ Access Mode Sets the hard drive access mode. Options are: Auto (default), CHS, LBA, Large.
- ☛ Capacity Approximate capacity of the currently installed hard drive.

☞ Halt On

Allows you to determine whether the system will stop for an error during the POST.

Options are: "All Errors," "No Errors," "All, But Keyboard". (Default)

☞ Memory

These fields are read-only and are determined by the BIOS POST.

2-4 Advanced BIOS Features

CMOS Setup Utility-Copyright (C) 1984-2012 Award Software
Advanced BIOS Features

		Item Help
▶ IGX Configuration	[Press Enter]	Menu Level ▶
Load Line Control	[Auto]	
AMD C1E Support	[Disabled]	
AMD C6 Support <small>(Note)</small>	[Enabled]	
Virtualization	[Disabled]	
AMD K8 Cool&Quiet control	[Auto]	
AMD APM Master Mode <small>(Note)</small>	[Auto]	
CPU core Control <small>(Note)</small>		
x One Core Per Compute Unit <small>(Note)</small>	Disabled	
x CPU core 1-2 <small>(Note)</small>	Enabled	
x CPU core 3-4 <small>(Note)</small>	Enabled	
▶ Hard Disk Boot Priority	[Press Enter]	
EFI CD/DVD Boot Option	[Auto]	
First Boot Device	[Hard Disk]	
Second Boot Device	[CDROM]	
Third Boot Device	[USB-HDD]	
Password Check	[Setup]	
HDD S.M.A.R.T. Capability	[Disabled]	
Away Mode	[Disabled]	
Init Display First	[PCI Slot]	

↑↓→←: Move Enter: Select +/-/PU/PD: Value F10: Save ESC: Exit F1: General Help
 F5: Previous Values F6: Fail-Safe Defaults F7: Optimized Defaults

☞ IGX Configuration

The settings in this submenu are synchronous to those under the same items on the **MB Intelligent Tweaker(M.I.T.)** main menu.

☞ Load Line Control

Enables or disables Load Line control. This item allows you to adjust Vdroop at different levels. Enabling Load-Line Calibration may keep the CPU voltage more constant under light and heavy CPU load. **Auto** lets the BIOS automatically configure this setting. (Default: Auto)

☞ AMD C1E Support

Enables or disables the C1E CPU power-saving function in system halt state. When enabled, the power consumption will be reduced during system halt state.

- ☛ Enabled If a CPU that supports hardware C1E is installed, the BIOS will automatically enable the hardware C1E function. If not, the BIOS will enable the software C1E function.
- ☛ Disabled Disables this function. (Default)

(Note) This item is present only when you install a CPU that supports this feature.

- ☞ **AMD C6 Support** ^(Note)
 Allows you to determine whether to let the CPU enter C6 mode in system halt state. When enabled, the CPU core frequency will be reduced during system halt state to decrease power consumption. The C6 state is a more enhanced power-saving state than C1. (Default: Enabled)
- ☞ **Virtualization**
 Virtualization enhanced by Virtualization Technology will allow a platform to run multiple operating systems and applications in independent partitions. With virtualization, one computer system can function as multiple virtual systems. (Default: Disabled)
- ☞ **AMD K8 Cool&Quiet control**

 - ▶▶ Auto Lets the AMD Cool'n'Quiet driver dynamically adjust the CPU clock and VID to reduce heat output from your computer and its power consumption. (Default)
 - ▶▶ Disabled Disables this function.
- ☞ **AMD APM Master Mode (AMD Application Power Management Function)** ^(Note)

 - ▶▶ Auto Lets BIOS automatically configure this setting. (Default)
 - ▶▶ Enabled Dynamically monitors the power consumption of the CPU cores and automatically optimizes the CPU to its best performance level.
 - ▶▶ Disabled Disables this function.
- ☞ **CPU core Control**
 Allows you to determine whether to manually enable/disable CPU cores.

 - ▶▶ Auto Lets the BIOS to enable all CPU cores (number of cores available depends on the CPU being used). (Default)
 - ▶▶ Manual Allows you to individually enable/disable CPU Core.
- ☞ **One Core Per Compute Unit** ^(Note)
 Enables or disables one core of each Compute Unit. If set to **Enabled**, each Compute Unit will operate with only one core and the **CPU core 3-4** items will become unconfigurable. This item is configurable only when **CPU core Control** is set to **Manual**. (Default: Disabled)
- ☞ **CPU core 1-2** ^(Note)
 This setting is fixed. CPU Core 1-2 is always enabled.
- ☞ **CPU core 3-4** ^(Note)
 Allows you to enable/disable each Compute Unit respectively. If set to **Disabled**, both cores of the CPU Unite will be disabled. This item is configurable only when **One Core Per Compute Unit** is set to **Disabled**. (Default: Enabled)
- ☞ **Hard Disk Boot Priority**
 Specifies the sequence of loading the operating system from the installed hard drives.
 Use the up or down arrow key to select a hard drive, then press the plus key <+> (or <PageUp>) or the minus key <-> (or <PageDown>) to move it up or down on the list. Press <Esc> to exit this menu when finished.
- ☞ **EFI CD/DVD Boot Option**
 Set this item to **EFI** if you want to install the operating system to a hard drive larger than 2.2 TB. Make sure the operating system to be installed supports booting from a GPT partition, such as Windows 7 64-bit and Windows Server 2003 64-bit. **Auto** lets the BIOS automatically configure this setting depending on the hard drive you install. (Default: Auto)
- ☞ **First/Second/Third Boot Device**
 Specifies the boot order from the available devices. Use the up or down arrow key to select a device and press <Enter> to accept. Options are: LS120, Hard Disk, CDROM, ZIP, USB-FDD, USB-ZIP, USB-CDROM, USB-HDD, Legacy LAN, Disabled.

(Note) This item is present only when you install a CPU that supports this feature.

☞ Password Check

Specifies whether a password is required every time the system boots, or only when you enter BIOS Setup. After configuring this item, set the password(s) under the **Set Supervisor/User Password** item in the BIOS Main Menu.

- ▶▶ Setup A password is only required for entering the BIOS Setup program. (Default)
- ▶▶ System A password is required for booting the system and for entering the BIOS Setup program.

☞ HDD S.M.A.R.T. Capability

Enables or disables the S.M.A.R.T. (Self Monitoring and Reporting Technology) capability of your hard drive. This feature allows your system to report read/write errors of the hard drive and to issue warnings when a third party hardware monitor utility is installed. (Default: Disabled)

☞ Away Mode

Enables or disables Away Mode in Windows XP Media Center operating system. Away Mode allows the system to silently perform unattended tasks while in a low-power mode that appears off. (Default: Disabled)

☞ Init Display First

Specifies the first initiation of the monitor display from the installed PCI graphics card, PCI Express graphics card, or the onboard graphics.

- ▶▶ PCI Slot Sets the PCI graphics card as the first display. (Default)
- ▶▶ OnChipVGA Sets the onboard graphics as the first display.
- ▶▶ PEG Sets the PCI Express graphics card on the PCIEX16 slot as the first display.

2-5 Integrated Peripherals

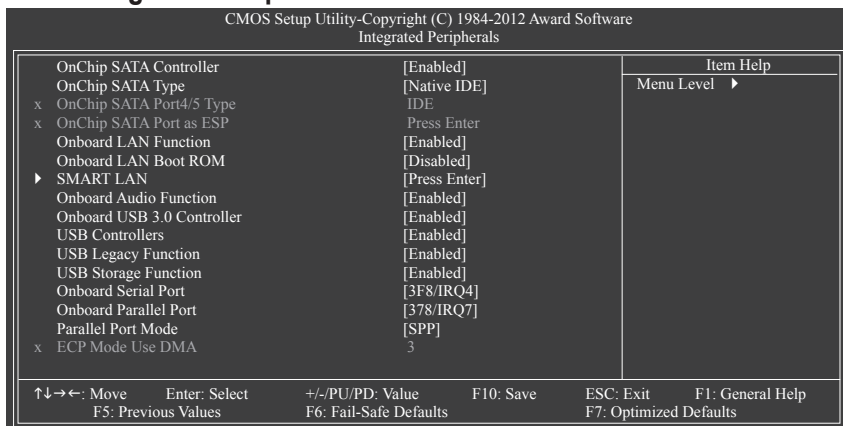

☞ OnChip SATA Controller

Enables or disables the integrated SATA controllers. (Default: Enabled)

☞ OnChip SATA Type (SATA2 0~SATA2 3 connectors)

Configures the operating mode of the integrated SATA controller.

- ▶▶ Native IDE Allows the SATA controllers to operate in Native IDE mode. Enable Native IDE mode if you wish to install operating systems that support Native mode. (Default)
- ▶▶ RAID Enables RAID for the SATA controller.
- ▶▶ AHCI Configures the SATA controllers to AHCI mode. Advanced Host Controller Interface (AHCI) is an interface specification that allows the storage driver to enable advanced Serial ATA features such as Native Command Queuing and hot plug.

- ☞ **OnChip SATA Port4/5 Type (SATA2 4/SATA2 5 connectors)**
 This option is configurable only when **OnChip SATA Type** is set to **RAID** or **AHCI**. Configures the operating mode of the integrated SATA2 4~SATA2 5 connectors.

 - ▶▶ IDE Disables RAID for the SATA controller and configures the SATA controller to PATA mode. (Default)
 - ▶▶ As SATA Type The mode depends on the **OnChip SATA Type** settings.
- ▶ **OnChip SATA Port as ESP**
- ☞ **Port0 as ESP/Port1 as ESP/Port2 as ESP/Port3 as ESP**
 This option is configurable only when **OnChip SATA Type** is set to **AHCI**. **Enabled** will speed up the hot plug detection of the connected SATA device. (Default: Disabled)
- ☞ **Port4 as ESP/Port5 as ESP**
 This option is configurable only when **OnChip SATA Type** is set to **AHCI** and **OnChip SATA Type Port4/5** is set to **As SATA Type**. **Enabled** will speed up the hot plug detection of the connected SATA device. (Default: Disabled)
- ☞ **Onboard LAN Function**
 Enables or disables the onboard LAN function. (Default: Enabled)
 If you wish to install a 3rd party add-in network card instead of using the onboard LAN, set this item to **Disabled**.
- ☞ **Onboard LAN Boot ROM**
 Allows you to decide whether to activate the boot ROM integrated with the onboard LAN chip. (Default: Disabled)
- ▶ **SMART LAN (LAN Cable Diagnostic Function)**
 This motherboard incorporates cable diagnostic feature designed to detect the status of the attached LAN cable. This feature will detect cabling issue and report the approximate distance to the fault or short.
- ☞ **Onboard Audio Function**
 Enables or disables the onboard audio function. (Default: Enabled)
 If you wish to install a 3rd party add-in audio card instead of using the onboard audio, set this item to **Disabled**.
- ☞ **Onboard USB 3.0 Controller (VIA® VL805 USB Controller)**
 Enables or disables the VIA® VL805 USB controller. (Default: Enabled)
- ☞ **USB Controllers**
 Enables or disables the integrated USB controller. (Default: Enabled)
Disabled will turn off all of the USB functionalities below.
- ☞ **USB Legacy Function**
 Allows USB keyboard to be used in MS-DOS. (Default: Enabled)
- ☞ **USB Storage Function**
 Determines whether to detect USB storage devices, including USB flash drives and USB hard drives during the POST. (Default: Enabled)
- ☞ **Onboard Serial Port**
 Enables or disables the onboard serial port and specifies its base I/O address and corresponding interrupt. Options are: Auto, 3F8/IRQ4 (default), 2F8/IRQ3, 3E8/IRQ4, 2E8/IRQ3, Disabled.
- ☞ **Onboard Parallel Port**
 Enables or disables the onboard parallel port (LPT) and specifies its base I/O address and corresponding interrupt. Options are: 378/IRQ7 (default), 278/IRQ5, 3BC/IRQ7, Disabled.
- ☞ **Parallel Port Mode**
 Selects an operating mode for the onboard parallel (LPT) port. Options are: SPP (Standard Parallel Port) (Default), EPP (Enhanced Parallel Port), ECP (Extended Capabilities Port), ECP+EPP.

⌘ ECP Mode Use DMA

Selects DMA channel for the LPT port in ECP mode. This item is configurable only if **Parallel Port Mode** is set to **ECP** or **ECP+EPP**. Options are: 3 (default), 1.

2-6 Power Management Setup

CMOS Setup Utility-Copyright (C) 1984-2012 Award Software Power Management Setup		
		Item Help
ACPI Suspend Type	[S3(STR)]	Menu Level ▶
Soft-Off by Power button	[Instant-off]	
USB Wake Up from S3	[Enabled]	
Modem Ring Resume	[Disabled]	
PME Event Wake Up	[Enabled]	
HPET Support	[Enabled]	
Power On By Mouse	[Disabled]	
Power On By Keyboard	[Disabled]	
x KB Power ON Password	Enter	
AC Back Function	[Soft-Off]	
Power-On by Alarm	[Disabled]	
x Date (of Month)	Everyday	
x Resume Time (hh:mm:ss)	0 : 0 : 0	
ErP Support	[Disabled]	

↑↓→←: Move Enter: Select +/-/PU/PD: Value F10: Save ESC: Exit F1: General Help
F5: Previous Values F6: Fail-Safe Defaults F7: Optimized Defaults

⌘ ACPI Suspend Type

Specifies the ACPI sleep state when the system enters suspend.

- ▶▶ S1(POS) Enables the system to enter the ACPI S1 (Power on Suspend) sleep state. In S1 sleep state, the system appears suspended and stays in a low power mode. The system can be resumed at any time.
- ▶▶ S3(STR) Enables the system to enter the ACPI S3 (Suspend to RAM) sleep state (default). In S3 sleep state, the system appears to be off and consumes less power than in the S1 state. When signaled by a wake-up device or event, the system resumes to its working state exactly where it was left off.

⌘ Soft-Off by Power button

Configures the way to turn off the computer in MS-DOS mode using the power button.

- ▶▶ Instant-Off Press the power button and then the system will be turned off instantly. (Default)
- ▶▶ Delay 4 Sec Press and hold the power button for 4 seconds to turn off the system. If the power button is pressed for less than 4 seconds, the system will enter suspend mode.

⌘ USB Wake Up from S3

Allows the system to be awakened from ACPI S3 sleep state by a wake-up signal from the installed USB device. (Default: Enabled)

⌘ Modem Ring Resume

Allows the system to be awakened from an ACPI sleep state by a wake-up signal from a modem that supports wake-up function. (Default: Disabled)

⌘ PME Event Wake Up

Allows the system to be awakened from an ACPI sleep state by a wake-up signal from a PCI or PCIe device. Note: To use this function, you need an ATX power supply providing at least 1A on the +5VSB lead. (Default: Enabled)

⌘ HPET Support

Enables or disables High Precision Event Timer (HPET) for Windows 7 operating system. (Default: Enabled)

Power On By Mouse

Allows the system to be turned on by a PS/2 mouse wake-up event.

Note: To use this function, you need an ATX power supply providing at least 1A on the +5VSB lead.

- ▶ Disabled Disables this function. (Default)
- ▶ Double Click Double click on left button on the PS/2 mouse to turn on the system.

Power On By Keyboard

Allows the system to be turned on by a PS/2 keyboard wake-up event.

Note: To use this function, you need an ATX power supply providing at least 1A on the +5VSB lead.

- ▶ Disabled Disables this function. (Default)
- ▶ Password Set a password with 1~5 characters to turn on the system.
- ▶ Any KEY Press any key on the keyboard to turn on the system.
- ▶ Keyboard 98 Press POWER button on the Windows 98 keyboard to turn on the system.

KB Power ON Password

Set the password when **Power On By Keyboard** is set to **Password**.

Press <Enter> on this item and set a password with up to 5 characters and then press <Enter> to accept.

To turn on the system, enter the password and press <Enter>.

Note: To cancel the password, press <Enter> on this item. When prompted for the password, press <Enter> again without entering the password to clear the password settings.

AC Back Function

Determines the state of the system after the return of power from an AC power loss.

- ▶ Soft-Off The system stays off upon the return of the AC power. (Default)
- ▶ Full-On The system is turned on upon the return of the AC power.
- ▶ Memory The system returns to its last known awake state upon the return of the AC power.

Power-On by Alarm

Determines whether to power on the system at a desired time. (Default: Disabled)

If enabled, set the date and time as following:

- ▶ Date (of Month) Alarm: Turn on the system at a specific time on each day or on a specific day in a month.
- ▶ Resume Time (hh: mm: ss): Set the time at which the system will be powered on automatically.

Note: When using this function, avoid inadequate shutdown from the operating system or removal of the AC power, or the settings may not be effective.

ErP Support

Determines whether to let the system consume least power in S5 (shutdown) state. (Default: Disabled)

Note: When this item is set to **Enabled**, the following functions will become unavailable: Power-On by Alarm, PME event wake up, power on by mouse, power on by keyboard, and wake on LAN.

2-7 PnP/PCI Configurations

CMOS Setup Utility-Copyright (C) 1984-2012 Award Software
PnP/PCI Configurations

PCI1 IRQ Assignment	[Auto]	Item Help
		Menu Level ▶
↑↓←→: Move	Enter: Select	+/-/PU/PD: Value
F5: Previous Values	F6: Fail-Safe Defaults	F10: Save
		ESC: Exit
		F1: General Help
		F7: Optimized Defaults

PCI1 IRQ Assignment

- ▶ Auto BIOS auto-assigns IRQ to the first PCI slot. (Default)
- ▶ 3,4,5,7,9,10,11,12,14,15 Assigns IRQ 3,4,5,7,9,10,11,12,14,15 to the first PCI slot.

2-8 PC Health Status

CMOS Setup Utility-Copyright (C) 1984-2012 Award Software		Item Help
PC Health Status		Menu Level ▶
Hardware Thermal Control	[Enabled]	
Reset Case Open Status	[Disabled]	
Case Opened	No	
Vcore	1.280V	
DDR3 1.5V	1.500V	
+12V	12.168V	
+3.3V	3.397V	
Current System Temperature	37°C	
Current CPU Temperature	37°C	
Current CPU FAN Speed	1264 RPM	
Current SYSTEM FAN Speed	0 RPM	
CPU Warning Temperature	[Disabled]	
CPU FAN Fail Warning	[Disabled]	
SYSTEM FAN Fail Warning	[Disabled]	
CPU Smart FAN Control	[Enabled]	
System Smart FAN Control	[Enabled]	
↑↓→←: Move Enter: Select +/-/PU/PD: Value F10: Save ESC: Exit F1: General Help		
F5: Previous Values F6: Fail-Safe Defaults		F7: Optimized Defaults

Hardware Thermal Control

Enables or disables the CPU overheating protection function. When enabled, the CPU core voltage and ratio will be reduced when the CPU is overheated. (Default: Enabled)

Reset Case Open Status

- ▶▶ Disabled Keeps or clears the record of previous chassis intrusion status. (Default)
- ▶▶ Enabled Clears the record of previous chassis intrusion status and the **Case Opened** field will show "No" at next boot.

Case Opened

Displays the detection status of the chassis intrusion detection device attached to the motherboard CI header. If the system chassis cover is removed, this field will show "Yes", otherwise it will show "No". To clear the chassis intrusion status record, set **Reset Case Open Status** to **Enabled**, save the settings to the CMOS, and then restart your system.

Current Voltage(V) Vcore/DDR3 1.5V/+12V/+3.3V

Displays the current system voltages.

Current System/CPU Temperature

Displays current System/CPU temperature.

Current CPU/SYSTEM FAN Speed (RPM)

Displays current CPU/system fan speed.

CPU Warning Temperature

Sets the warning threshold for CPU temperature. When CPU temperature exceeds the threshold, BIOS will emit warning sound. Options are: Disabled (default), 60°C/140°F, 70°C/158°F, 80°C/176°F, 90°C/194°F.

CPU/SYSTEM FAN Fail Warning

Allows the system to emit warning sound if the fan is not connected or fails. Check the fan condition or fan connection when this occurs. (Default: Disabled)

CPU/System Smart FAN Control

Enables or disables the fan speed control function. **Enabled** allows the fan to run at different speed according to the temperature. You can adjust the fan speed with EasyTune based on system requirements. If disabled, CPU fan runs at full speed. (Default: Enabled)

2-9 Load Fail-Safe Defaults

Press <Enter> on this item and then press the <Y> key to load the safest BIOS default settings. In case system instability occurs, you may try to load Fail-Safe defaults, which are the safest and most stable BIOS settings for the motherboard.

2-10 Load Optimized Defaults

Press <Enter> on this item and then press the <Y> key to load the optimal BIOS default settings. The BIOS defaults settings help the system to operate in optimum state. Always load the Optimized defaults after updating the BIOS or after clearing the CMOS values.

2-11 Set Supervisor/User Password

Press <Enter> on this item and type the password with up to 8 characters and then press <Enter>. You will be requested to confirm the password. Type the password again and press <Enter>. The BIOS Setup program allows you to specify two separate passwords:

↳ Supervisor Password

When a system password is set and the **Password Check** item in **Advanced BIOS Features** is set to **Setup**, you must enter the supervisor password for entering BIOS Setup and making BIOS changes. When the Password Check item is set to **System**, you must enter the supervisor password (or user password) at system startup and when entering BIOS Setup.

↳ User Password

When the **Password Check** item is set to **System**, you must enter the supervisor password (or user password) at system startup to continue system boot. In BIOS Setup, you must enter the supervisor password if you wish to make changes to BIOS settings. The user password only allows you to view the BIOS settings but not to make changes.

To clear the password, press <Enter> on the password item and when requested for the password, press <Enter> again. The message "PASSWORD DISABLED" will appear, indicating the password has been cancelled.

NOTE: Before setting the User Password, be sure to set the Administrator Password first.

2-12 Save & Exit Setup

Press <Enter> on this item and press the <Y> key. This saves the changes to the CMOS and exits the BIOS Setup program. Press <N> or <Esc> to return to the BIOS Setup Main Menu.

2-13 Exit Without Saving

Press <Enter> on this item and press the <Y> key. This exits the BIOS Setup without saving the changes made in BIOS Setup to the CMOS. Press <N> or <Esc> to return to the BIOS Setup Main Menu.

Chapter 3 Appendix

3-1 Drivers Installation



- Before installing the drivers, first install the operating system.
- After installing the operating system, insert the motherboard driver disk into your optical drive. The driver Autorun screen is automatically displayed which looks like that shown in the screen shot below. (If the driver Autorun screen does not appear automatically, go to My Computer, double-click the optical drive and execute the **Run.exe** program.)

After inserting the driver disk, "Xpress Install" will automatically scan your system and then list all the drivers that are recommended to install. You can click the **Install All** button and "Xpress Install" will install all the recommended drivers. Or click **Install Single** Items to manually select the drivers you wish to install.

3-2 Configuring SATA Hard Drive(s)

Before you begin

- At least two SATA hard drives (to ensure optimal performance, it is recommended that you use two hard drives with identical model and capacity). If you do not want to create RAID, you may prepare only one hard drive.
- Windows setup disk.
- Motherboard driver disk.
- A USB floppy disk drive (needed during Windows XP installation)
- An empty formatted floppy disk (needed during Windows XP installation)

Configuring the Onboard SATA Controller

A. Installing SATA hard drive(s) in your computer

Attach one end of the SATA signal cable to the rear of the SATA hard drive and the other end to available SATA port on the motherboard. Then connect the power connector from your power supply to the hard drive.

B. Configuring SATA controller mode in BIOS Setup

Make sure to configure the SATA controller mode correctly in system BIOS Setup. For the BIOS Setup menus, refer to Chapter 2, "BIOS Setup," "Integrated Peripherals." Steps:

1. Turn on your computer and press <Delete> to enter BIOS Setup during the POST (Power-On Self-Test). Ensure **OnChip SATA Controller** is enabled under **Integrated Peripherals**. To enable RAID for the SATA2 0/1/2/3 connectors, set **OnChip SATA Type** to **RAID**. To enable RAID for the SATA2 4/SATA2 5 connectors, set **OnChip SATA Type** to **RAID** and set **OnChip SATA Port4/5 Type** to **As SATA Type**.
2. Save changes and exit BIOS Setup.



The BIOS Setup menus described in this section may differ from the exact settings for your motherboard. The actual BIOS Setup menu options you will see shall depend on the motherboard you have and the BIOS version.

C. Configuring a RAID array in RAID BIOS

Enter the RAID BIOS setup utility to configure a RAID array. After the POST memory test begins and before the operating system boot begins, look for a message which says "Press <Ctrl-F> to enter RAID Option ROM Utility". Press <Ctrl> + <F> to enter the RAID BIOS setup utility. To create a new array, press <2> to enter the **Define LD Menu** window, use the up or down arrow key to move to an item for further configuration. In the following procedure, we'll create RAID 0 as an example.

Steps:

1. Under the **RAID Mode** section, press the <SPACE> key to select **RAID 0**.
2. Set the **Stripe Block** size. 64 KB is the default.
3. Under the **Drives Assignments** section, press the up or down arrow key to highlight a drive.
4. Press the <SPACE> key or <Y> to change the **Assignment** option to **Y**. This action adds the drive to the disk array. The **Total Drv** section will show the number of disks assigned.
5. Press <Ctrl>+<Y> keys to save the information. The message in Figure 1 will appear. Press <Ctrl>+<Y> to clear the MBR or press other keys to ignore this option.

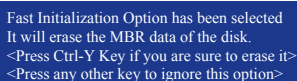
A blue rectangular message box with white text. The text reads: "Fast Initialization Option has been selected. It will erase the MBR data of the disk. <Press Ctrl-Y Key if you are sure to erase it> <Press any other key to ignore this option>".

Fast Initialization Option has been selected
It will erase the MBR data of the disk.
<Press Ctrl-Y Key if you are sure to erase it>
<Press any other key to ignore this option>

Figure 1

6. Then, the window below will appear. Press <Ctrl>+<Y> to set the capacity of the RAID array or press other keys to set the array to its maximum capacity.

A blue rectangular message box with white text. The text reads: "Press Ctrl-Y to Modify Array Capacity or press any other key to use maximum capacity...".

Press Ctrl-Y to Modify Array Capacity or press any
other key to use maximum capacity...

Figure 2

7. After the creation is complete, the screen will return to **Define LD Menu** where you will see the newly-created array.
8. Press <Esc> to return to **Main Menu** and press <Esc> again if you want to exit the RAID BIOS utility.

Making a SATA RAID/AHCI Driver Diskette

Before installing Windows XP, connect a USB floppy disk drive to your computer first because you need to install the SATA RAID/AHCI driver from a floppy disk that contains the driver during the OS installation. To copy the RAID/AHCI driver for Windows XP, copy all files in the **\BootDrv\SBxxx\86** folder in the motherboard driver disk to your floppy disk. To install Windows 64-Bit, copy the files in the **x64** folder.

Installing the SATA RAID/AHCI Driver and Operating System

A. Installing Windows XP

Restart your system to boot from the Windows XP setup disk and press <F6> as soon as you see the message "Press F6 if you need to install a 3rd party SCSI or RAID driver." Insert the floppy disk containing the SATA RAID/AHCI driver. Follow the on-screen instructions to install the driver that suits your operating system. When completed, proceed with the Windows XP installation.

B. Installing Windows 7

Restart your system to boot from the Windows 7 setup disk and perform standard OS installation steps. Select **Load Driver**. Insert the motherboard driver disk and then browse to the location of the driver. Then follow the on-screen instructions to load the driver. The locations of the drivers for Windows 7 are as follows:

RAID driver for Windows 32-bit: **\BootDrv\SBxxx\W7\RAID\W7**

RAID driver for Windows 64-bit: **\BootDrv\SBxxx\W7\RAID\W764A**

AHCI driver for Windows 32-bit: **\BootDrv\SBxxx\W7\AHCI\Win7x86**

AHCI driver for Windows 64-bit: **\BootDrv\SBxxx\W7\AHCI\Win7x64**

After loading the driver, continue the OS installation.

Regulatory Statements

Regulatory Notices

This document must not be copied without our written permission, and the contents there of must not be imparted to a third party nor be used for any unauthorized purpose.

Contravention will be prosecuted. We believe that the information contained herein was accurate in all respects at the time of printing. GIGABYTE cannot, however, assume any responsibility for errors or omissions in this text. Also note that the information in this document is subject to change without notice and should not be construed as a commitment by GIGABYTE.

Our Commitment to Preserving the Environment

In addition to high-efficiency performance, all GIGABYTE motherboards fulfill European Union regulations for RoHS (Restriction of Certain Hazardous Substances in Electrical and Electronic Equipment) and WEEE (Waste Electrical and Electronic Equipment) environmental directives, as well as most major worldwide safety requirements. To prevent releases of harmful substances into the environment and to maximize the use of our natural resources, GIGABYTE provides the following information on how you can responsibly recycle or reuse most of the materials in your "end of life" product.

Restriction of Hazardous Substances (RoHS) Directive Statement

GIGABYTE products have not intended to add and safe from hazardous substances (Cd, Pb, Hg, Cr+6, PBDE and PBB). The parts and components have been carefully selected to meet RoHS requirement. Moreover, we at GIGABYTE are continuing our efforts to develop products that do not use internationally banned toxic chemicals.

Waste Electrical & Electronic Equipment (WEEE) Directive Statement

GIGABYTE will fulfill the national laws as interpreted from the 2002/96/EC WEEE (Waste Electrical and Electronic Equipment) directive. The WEEE Directive specifies the treatment, collection, recycling and disposal of electric and electronic devices and their components. Under the Directive, used equipment must be marked, collected separately, and disposed of properly.

WEEE Symbol Statement



The symbol shown below is on the product or on its packaging, which indicates that this product must not be disposed of with other waste. Instead, the device should be taken to the waste collection centers for activation of the treatment, collection, recycling and disposal procedure. The separate collection and recycling of your waste equipment at the time of disposal will help to conserve natural resources and ensure that it is recycled in a manner that protects human health and the environment.

For more information about where you can drop off your waste equipment for recycling, please contact your local government office, your household waste disposal service or where you purchased the product for details of environmentally safe recycling.

- ◆ When your electrical or electronic equipment is no longer useful to you, "take it back" to your local or regional waste collection administration for recycling.
- ◆ If you need further assistance in recycling, reusing in your "end of life" product, you may contact us at the Customer Care number listed in your product's user's manual and we will be glad to help you with your effort.

Finally, we suggest that you practice other environmentally friendly actions by understanding and using the energy-saving features of this product (where applicable), recycling the inner and outer packaging (including shipping containers) this product was delivered in, and by disposing of or recycling used batteries properly. With your help, we can reduce the amount of natural resources needed to produce electrical and electronic equipment, minimize the use of landfills for the disposal of "end of life" products, and generally improve our quality of life by ensuring that potentially hazardous substances are not released into the environment and are disposed of properly.

FCC Notice (U.S.A. Only)

This equipment has been tested and found to comply with the limits for a Class B digital device, pursuant to Part 15 of the FCC Rules. These limits are designed to provide reasonable protection against harmful interference in a residential installation. This equipment generates, uses, and can radiate radio frequency energy and, if not installed and used in accordance with the instructions, may cause harmful interference to radio communications. However, there is no guarantee that interference will not occur in a particular installation. If this equipment does cause harmful interference to radio or television reception, which can be determined by turning the equipment off and on, the user is encouraged to try to correct the interference by one or more of the following measures:

- ◆ Reorient or relocate the receiving antenna.
- ◆ Increase the separation between the equipment and receiver.
- ◆ Connect the equipment into an outlet on a circuit different from that to which the receiver is connected.
- ◆ Consult a dealer or experienced TV/radio technician for help.

Canada, Industry Canada (IC) Notices / Canada, avis d'Industry Canada (IC)

- ◆ This Class B digital apparatus complies with Canadian ICES-003 and RSS-210.
- ◆ Operation is subject to the following two conditions: (1) this device may not cause interference, and (2) this device must accept any interference, including interference that may cause undesired operation of the device.
- ◆ Cet appareil numérique de classe B est conforme aux normes canadiennes ICES-003 et RSS-210.
- ◆ Son fonctionnement est soumis aux deux conditions suivantes : (1) cet appareil ne doit pas causer d'interférence et (2) cet appareil doit accepter toute interférence, notamment les interférences qui peuvent affecter son fonctionnement.



Contact Us

GIGA-BYTE TECHNOLOGY CO., LTD.

Address: No.6, Baoqiang Rd., Xindian Dist., New Taipei City 231, Taiwan

TEL: +886-2-8912-4000, FAX: +886-2-8912-4005

Tech. and Non-Tech. Support (Sales/Marketing) : <http://esupport.gigabyte.com>

WEB address (English): <http://www.gigabyte.com>

WEB address (Chinese): <http://www.gigabyte.tw>

- **GIGABYTE eSupport**

To submit a technical or non-technical (Sales/Marketing) question, please link to:
<http://esupport.gigabyte.com>

The screenshot shows the GIGABYTE eSupport website. At the top left is the GIGABYTE logo. To the right is the 'eSupport' logo. Below these are three icons: 'Downloads', 'FAQ', and 'Warranty'. In the center, there is a 'Sign in with' section featuring social media icons for Facebook, Google+, and a generic user icon. Below this is the 'GIGABYTE Passport' login form, which includes fields for 'E-mail' and 'Password', a 'Forgot password?' link, and a red 'Login' button with a right-pointing arrow. A link 'Not a member yet?' is located to the right of the login button. At the bottom of the page, there is a small copyright notice: 'All intellectual property rights, including without limitation to copyright and trademark of this work and its derivative works are the property of, or are licensed to, GIGA-BYTE TECHNOLOGY CO., LTD. Any unauthorized use is strictly prohibited.'