



HD Camcorder

***XF100***

***XF105***

Instruction Manual

**HDMI**

**PAL**

# Important Usage Instructions

2

**WARNING:**



TO REDUCE THE RISK OF ELECTRIC SHOCK, DO NOT REMOVE COVER (OR BACK). NO USER SERVICEABLE PARTS INSIDE.  
REFER SERVICING TO QUALIFIED SERVICE PERSONNEL.

**WARNING:**



TO REDUCE THE RISK OF FIRE OR ELECTRIC SHOCK, DO NOT EXPOSE THIS PRODUCT TO RAIN OR MOISTURE.

**COPYRIGHT WARNING:**

Unauthorized recording of copyrighted materials may infringe on the rights of copyright owners and be contrary to copyright laws.

**CAUTION:**

TO REDUCE THE RISK OF ELECTRIC SHOCK AND TO REDUCE ANNOYING INTERFERENCE, USE THE RECOMMENDED ACCESSORIES ONLY.

**CAUTION:**

DISCONNECT THE MAINS PLUG FROM THE SUPPLY SOCKET WHEN NOT IN USE.

To reduce the risk of electric shock, do not expose this product to dripping or splashing.

**For Users in the UK**

When replacing the fuse only a correctly rated approved type should be used and be sure to re-fit the fuse cover.

The Mains plug is used as the disconnect device. The Mains plug shall remain readily operable to disconnect the plug in case of an accident.

**CAUTION:**

- Danger of explosion if the wrong type of batteries are attached. Use only the same type of batteries.
- Do not expose batteries or product to excessive heat such as the inside of a car under direct sunlight, fire, etc.

While using the compact power adapter, do not wrap it or cover it with a piece of cloth, and do not place it in confined narrow spaces. Heat may build up, the plastic case may deform and it could result in electric shock or fire.

CA-930 identification plate is located on the bottom.

**Only for European Union and EEA (Norway, Iceland and Liechtenstein)**



These symbols indicate that this product is not to be disposed of with your household waste, according to the WEEE Directive (2012/19/EU), the Battery Directive (2006/66/EC) and/or national legislation implementing those Directives.

■ If a chemical symbol is printed beneath the symbol shown above, in accordance with the Battery Directive, this indicates that a heavy metal (Hg = Mercury, Cd = Cadmium, Pb = Lead) is present in this battery or accumulator at a concentration above an applicable threshold specified in the Battery Directive.

This product should be handed over to a designated collection point, e.g., on an authorized one-for-one basis when you buy a new similar product or to an authorized collection site for recycling waste electrical and electronic equipment (EEE) and batteries and accumulators. Improper handling of this type of waste could have a possible impact on the environment and human health due to potentially hazardous substances that are generally associated with EEE. Your cooperation in the correct disposal of this product will contribute to the effective usage of natural resources.

For more information about the recycling of this product, please contact your local city office, waste authority, approved scheme or your household waste disposal service or visit [www.canon-europe.com/weee](http://www.canon-europe.com/weee), or [www.canon-europe.com/battery](http://www.canon-europe.com/battery).

**Trademark Acknowledgements**

- SD and SDHC Logos are trademarks of SD-3C, LLC.
- CompactFlash is a trademark of SanDisk Corporation.
- The Logo is a trademark of CompactFlash Association.
- Microsoft and Windows are trademarks or registered trademarks of Microsoft Corporation in the United States and/or other countries.
- Apple, Mac OS, Final Cut Pro are trademarks of Apple Inc., registered in the U.S. and other countries.
- Avid, Media Composer and NewsCutter are trademarks or registered trademarks of Avid Technology, Inc. or its subsidiaries in the United States and/or other countries.
- HDMI, the HDMI logo and High-Definition Multimedia Interface are trademarks or registered trademarks of HDMI Licensing LLC in the United States and other countries.
- Other names and products not mentioned above may be trademarks or registered trademarks of their respective companies.
- This device incorporates exFAT technology licensed from Microsoft.
- ANY USE OF THIS PRODUCT OTHER THAN CONSUMER PERSONAL USE IN ANY MANNER THAT COMPLIES WITH THE MPEG-2 STANDARD FOR ENCODING VIDEO INFORMATION FOR PACKAGED MEDIA IS EXPRESSLY PROHIBITED WITHOUT A LICENSE UNDER APPLICABLE PATENTS IN THE MPEG-2 PATENT PORTFOLIO, WHICH LICENSE IS AVAILABLE FROM MPEG LA, L.L.C., 250 STEELE STREET, SUITE 300, DENVER, COLORADO 80206.

# Highlights of the XF105/XF100

The Canon XF105/XF100 HD Camcorder has been designed with quality and functionality at the forefront while maintaining a compact size. The following are just some of the many features that will help turn your creative vision into reality.

4

## HD Recording

**CMOS system and DIGIC DV III image processor**  
The camcorder is equipped with a 1/3-type CMOS sensor that captures video at an effective pixel count of approximately 2.07 megapixels (1920x1080). Images are then processed by the state-of-the-art DIGIC DV III image processor.

### Superb HD video

The camcorder uses the MPEG-2 Long GOP codec. When you record using the 50 Mbps bit rate (with 4:2:2 color sampling), the quality of your recordings will rival that of broadcast video. Your recordings are saved as Material eXchange Format (MXF) files, which are compatible with major non-linear editing (NLE) software.

You can configure the video recording signal to suit your needs. By combining the bit rate/resolution setting with the frame rate setting, you can produce video from 1440x1080/25P at 25 Mbps to 1280x720/50P at 35 Mbps to 1920x1080/50i at 50 Mbps. You can select from a total of 11 different combinations!

## Operability

### Easy-to-use controls in a compact body

This camcorder has a variety of external controls at your fingertips, such as the manual ring, which allows you to adjust the focus, zoom or aperture simply by moving a switch and turning the ring. All of this is in a body that is so compact that you can carry and use the camcorder for long periods of time without experiencing fatigue.

### Face detection

When a subject's face is detected, the camcorder can track and focus on it. Furthermore, you can have the camcorder in manual focus but switch to autofocus only when a face is detected (📖 50), ensuring that important subjects are in focus.

## Recording media

The camcorder records video and audio to CompactFlash (CF) cards. You can even make lengthy recordings without worry because the camcorder features two CF card slots. When one CF card becomes full, the recording will automatically continue on the other one without interruption when you use relay recording (📖 38).

### Canon XF Utility software

Managing your recordings is as simple as using the **Canon XF Utility** software. You can transfer your recordings to your computer, where you can view and manage them. Using the associated plugins, you can then use the recordings with major NLE software\*.

\* Refer to *Saving Clips to a Computer* (📖 128) for details on compatible software.

## Versatile Artistic Expression

### Special recording modes

The special recording modes (📖 85) give you more creative control over your recordings. You can create a slow motion or fast motion effect in your recordings, record a certain number of frames at a set interval (ideal for subjects with little movement) or record a certain number of frames every time you press a button (ideal for stop motion animation).

### Custom picture settings

With custom picture settings (📖 96), you can enjoy unparalleled image control to deliver the "look" you want by adjusting parameters, such as gamma and sharpness. The custom picture settings can be recorded onto an SD card, which allows multiple XF105/XF100 camcorders to use the same settings, or embedded in the recording itself.

### Infrared recording

Record in darkness using infrared recording (📖 90). With the built-in infrared light, you can record nocturnal animals in their natural environment or other such scenes.



## Advanced Professional Features

### Pro-level connectivity (**XF105** only)

An industry-standard HD/SD SDI terminal (📖 124) for uncompressed HD signal output, embedded audio and SMPTE time code (LTC) give the camcorder the functionality of professional broadcast cameras. Genlock synchronization (📖 72) and time code synchronization (📖 72) allow the camcorder to be part of any multi-camera shooting setup.

### Customization

The camcorder features several customization options. You can assign often-used functions to assignable buttons (📖 94) so that you can call up those functions with the press of a single button. Custom functions (📖 104) and custom onscreen displays (📖 105) give you even more freedom to control many aspects of the camcorder's operation. Save custom picture and menu settings to an SD card so that you can transfer your setting preferences to other XF105/XF100 camcorders in order to use them in the same way.

## Other Functions

### Audio

Sound is recorded as 2-channel linear PCM audio (16-bit/48 kHz). You can use the built-in microphone, MIC audio input terminal or the two XLR audio input terminals (with phantom power supply) when recording.

### Video scopes

Check the brightness of the image using the waveform monitor (📖 81) or the focus using the edge monitor (📖 82).

### Added and improved functionality

Other functions include improved image stabilization (📖 52), the option to add metadata to recordings (📖 79), and the Intelligent System-compatible battery pack (📖 167). Also, optical axis shift (📖 92) and the focal length guide (📖 93) have been added to aid in 3D shooting.

# Table of Contents

## 1. Introduction 9

About this Manual 9

Conventions Used in this Manual 9

Supplied Accessories 11

Names of Parts 12

## 2. Preparations 21

Preparing the Power Supply 21

Using a Battery Pack 21

Turning the Camcorder On and Off 24

Date, Time and Language Settings 25

Setting the Date and Time 25

Changing the Time Zone 25

Displaying the Date and Time while Recording 26

Changing the Language 26

Using the Menus 27

Selecting an Option from the Menu 27

Preparing the Camcorder 29

Attaching the Microphone Holder Unit 29

Attaching the Lens Hood 29

Dioptric Adjustment 29

Using the LCD Panel 30

Using the Viewfinder and LCD Screen

Simultaneously 30

Adjusting the Viewfinder/LCD Screen 30

Setting the Screen to Black & White 31

Adjusting the Grip Belt 31

Attaching a Shoulder Strap 31

Removing and Attaching the Terminal Covers 32

Using the Wireless Controller 32

Using a Tripod 33

Preparing Recording Media 34

Inserting a CF Card 34

Checking the Status of the CF Card Slots 35

Removing a CF card 35

Inserting and Removing an SD Card 36

Initializing the Recording Media 36

Switching Between the CF Card Slots 37

Selecting the CF Card Recording Method 37

Checking the Available Recording Time 38

Recovering Data on the CF Card 38

## 3. Recording 39

Recording Video 39

Preparing to Record 39

Recording 39

Onscreen Displays 42

Power Save Mode 44

Video Configuration: Bit Rate, Resolution and Frame Rate 45

Custom Button and Dial 46

Adjusting the Focus 47

Manual Focus Mode 47

Using the Focus Assistance Functions 48

Autofocus Mode 49

Detecting and Focusing On Faces 50

Focus Limit and Macro Shooting 51

Image Stabilizer 52

Gain 53

Automatic Gain Control (AGC) 53

Manual Gain Control 54

Shutter Speed 55

Changing the Shutter Speed Mode 56

Flicker Reduction 56

Adjusting the Aperture 57

Automatic Aperture Control 57

Manual Aperture Control 57

Adjusting the AE Level 58

Setting the Light Metering Mode 58

White Balance 59

Auto White Balance 59

Preset White Balance 59

Setting the Color Temperature 60

Custom White Balance 61

Zooming 62

Using the Manual Ring 62

Using the Zoom Rockers, Wireless Controller or  
Optional Remote Control 62

Soft Zoom Control 65

Using Optional Conversion Lenses 66

Onscreen Markers and Zebra Patterns 67

Displaying Onscreen Markers 67

Displaying Zebra Patterns 68

Setting the Time Code 69  
  Selecting the Running Mode 69  
  Putting the Time Code Display on Hold 70

Setting the User Bit 71

**XF105** Synchronizing with an External Device 72  
  Connecting an External Device 72  
  Using a Reference Video Signal (Genlock Synchronization) 72  
  Using a Time Code Signal 72  
  Time Code Signal Output 73

Recording Audio 74  
  Using the Built-in or External Microphone Connected to the MIC Terminal 74  
  Using Line Input or an External Microphone Connected to an XLR Terminal 75  
  Adjusting the Audio Level 77  
  Monitoring the Audio with Headphones 78

Using Metadata 79  
  Setting a User Memo 79

Color Bars/Audio Reference Signal 80  
  Recording Color Bars 80  
  Recording an Audio Reference Signal 80

Video Scopes 81  
  Displaying a Video Scope 81  
  Configuring the Waveform Monitor 81  
  Configuring the Edge Monitor 82

Adding Shot Marks while Recording 83

Reviewing a Recording 84

Special Recording Modes 85  
  Interval Recording Mode 85  
  Frame Recording Mode 86  
  Slow & Fast Motion Mode 87  
  Pre-recording Mode 88

Infrared Recording 90  
  Activating Infrared Mode 90  
  Using the Infrared Light 90

Optical Axis Shift 92

Using the Focal Length Guide 93

## 4. Customization 94

Assignable Buttons 94  
  Changing the Assigned Function 94  
  Using an Assignable Button 95

Custom Picture Settings 96  
  Selecting Custom Picture Files 96  
  Editing a Custom Picture File's Settings 97  
  Renaming Custom Picture Files 97  
  Protecting Custom Picture Files 97  
  Transferring Custom Picture Files 98  
  Embedding Custom Picture Settings in a Recording 99  
  Available Custom Picture Settings 99

Customizing Functions and Onscreen Displays 104  
  Customizing Functions 104  
  Customizing Onscreen Displays 105

Saving and Loading Camera Settings 106  
  Saving Camera Settings to an SD Card 106  
  Loading Camera Settings from an SD Card 106

## 5. Playback 107

Playback 107  
  Clip Index Screen 107  
  Playing Back Clips 109  
  Onscreen Displays 110  
  Playback Controls 111  
  Adjusting the Volume 111  
  Adding Shot Marks during Playback 112

**Clip Operations 113**

- Using the Clip Menu 114
- Displaying Clip Information 114
- Adding  Marks or  Marks 115
- Deleting  Marks or  Marks 115
- Copying Clips 116
- Deleting Clips 117
- Deleting the User Memo 117
- Copying a Custom Picture File Embedded in a Clip 118
- Displaying an Index Screen of Shot Marks 118
- Displaying a Frame Index Screen of a Single Clip 119
- Adding or Deleting Shot Marks from an Index Screen 119
- Changing a Clip's Thumbnail 120

**6. External Connections 121****Video Output Configuration 121**

- Video Output Configuration by Terminal 121
- SD Output 122

**Connecting to an External Monitor 123**

- Connection Diagram 123
- XF105** Using the HD/SD SDI Terminal 124
- Using the HDMI OUT Terminal 124
- Using the HD/SD COMPONENT OUT Terminal 124
- Using the AV Terminal 125
- Superimposing Onscreen Displays to Appear on an External Monitor 125

**Audio Output 126**

- XF105** Embedded Audio 126
- Synchronizing the Video with the Audio being Monitored 126
- Selecting the Audio Channel 126
- Selecting the Output Level of the AV Terminal 127

**Saving Clips to a Computer 128**

- Saving MXF Clips 128
- Installing Canon XF Utility (Windows) 128
- Installing Canon XF Utility (Mac OS) 129
- Viewing the Software Instruction Manuals 131

**7. Photos 132****Taking Photos 132**

- Taking Photos in CAMERA Mode 132
- Capturing Photos in MEDIA Mode 132

**Photo Playback 134**

- Displaying the [Photos] Index Screen 134
- Viewing Photos 134

**Photo Operations 135**

- Using the Photo Menu 135
- Deleting Photos 135
- Protecting Photos 136
- Copying Custom Picture Files 137
- Photo Numbering 138

**8. Additional Information 139****Menu Options 139****Displaying the Status Screens 150****Troubleshooting 156**

- List of Messages 159

**Handling Precautions 162****Maintenance/Others 165****Optional Accessories 166****Specifications 170****Index 174**

## About this Manual

Thank you for purchasing the Canon XF105/XF100. Please read this manual carefully before you use the camcorder and retain it for future reference. Should the camcorder fail to operate correctly, refer to *Troubleshooting* (📖 156).

### Conventions Used in this Manual

- **!** IMPORTANT: Precautions related to the camcorder's operation.
- **i** NOTES: Additional topics that complement the basic operating procedures.
- **📖**: Reference page number.
- **XF105**: Text that applies only to the model shown in the icon.
- The following terms are used in this manual.
  - “Screen” refers to the LCD screen and the viewfinder screen.
  - “CF card” refers to a CompactFlash (CF) card.
  - “SD card” refers to an SD or SDHC memory card.
  - “Recording media” refers to CF cards and SD cards.
- Photographs in the manual are simulated pictures taken with a still camera. Some screenshots have been altered to make them easier to read.
- Illustrations in the manual show the **XF105**.

Operating modes

**CAMERA** indicates that a function is available in the operating mode indicated and **CAMERA** indicates that the function is not available. For a detailed explanation, refer to *Turning the Camcorder On and Off* (24).

When a function requires the use of the menu, the quick reference shows the submenus and, when applicable, the default setting for the menu item. The example illustration indicates that you can find the function by selecting the [**Other Functions**] menu and then the [**Rec Review**] menu item.

Reviewing a Recording

### Reviewing a Recording

When the camcorder is in **CAMERA** mode, you can review the last clip that was recorded.

Operating modes: **CAMERA** **MEDIA**

- 1 Open the [**Rec Review**] submenu to set the review length.
 

[**Other Functions**] **[Rec Review]**
- 2 Select the desired option and then press SET.
 

[**Other Functions**]  
 [**Rec Review**]  
 [Last 4 sec]
- 3 After you finish recording, press the **SET** button.
  - The last clip that was recorded is played back without audio for the selected duration. **[REVIEW]** appears at the top of the screen.
  - Press the CANCEL button to stop reviewing the clip and change the camcorder back to record pause mode.
  - After the clip finishes playing back, the camcorder returns to record pause mode.

**Options**

[Entire Clip]: Allows you to review the entire clip.

[Last 4 sec]: Allows you to review just the last 4 seconds of the clip.

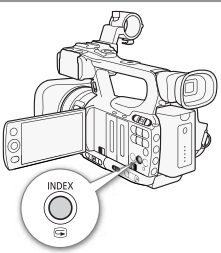

**NOTES**

- When you are using a special recording mode (88), you cannot review a clip.
- If the camcorder switched CF cards during a recording, the camcorder will play back the clip on the CF card most recently recorded on.

When a procedure requires selecting an option, the available options are listed within or after the procedure. Brackets [ ] are used to refer to menu options as they are displayed on screen.

The arrow is used to abbreviate menu selections. For a detailed explanation on how to use the menus, refer to *Using the Menus* (27). For a concise summary of all available menu options and settings, refer to the appendix *Menu Options* (139).

## Supplied Accessories

The following accessories are supplied with the camcorder.

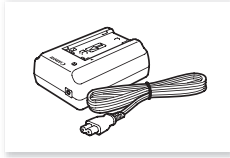

CA-930 Compact Power Adapter  
(incl. power cord)

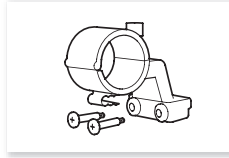

Microphone holder unit

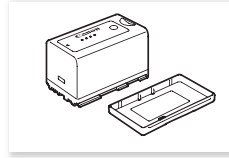

BP-925 Battery Pack  
(incl. terminal cover)

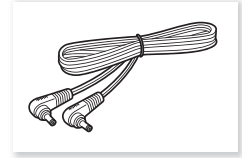

DC-930 DC Cable



CTC-100/S Component  
Cable

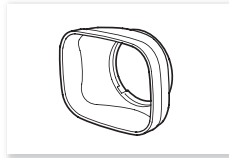

Lens Hood



Lens Cap



WL-D6000 Wireless Controller  
(incl. CR2025 Lithium Battery)

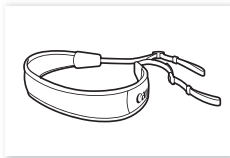

SS-1200 Shoulder Strap

## Names of Parts

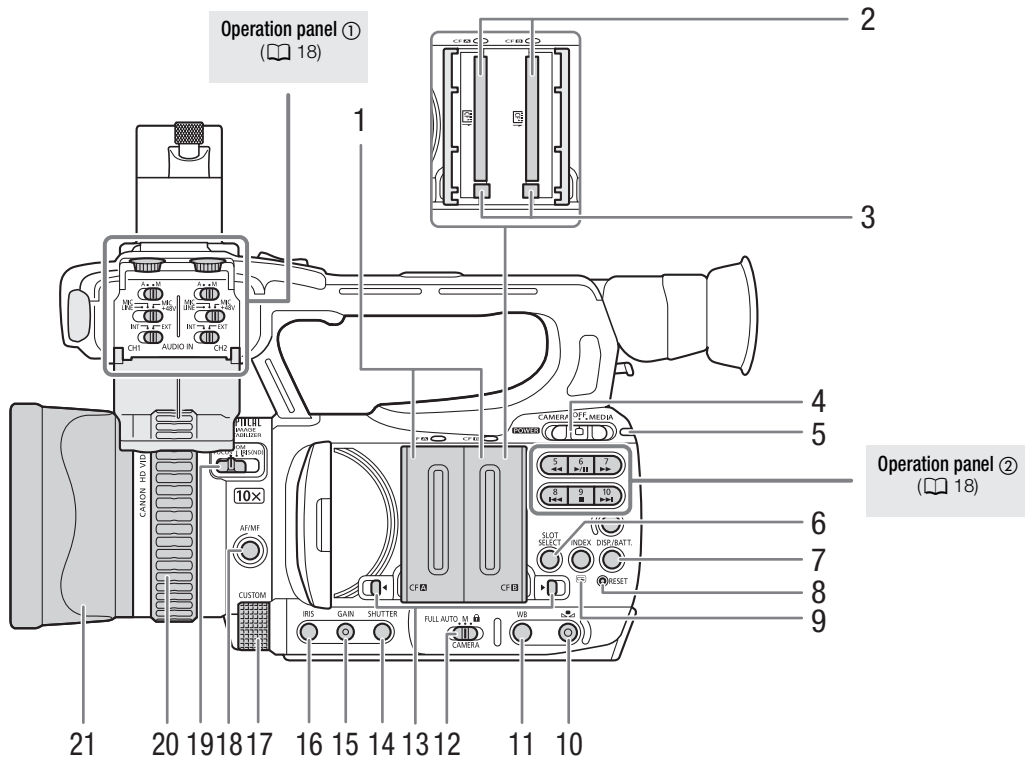

- |   |   |
|---|---|
| <ul style="list-style-type: none"> <li>1 CF card slot covers for CF card slot A (CF <b>A</b>) and CF card slot B (CF <b>B</b>)</li> <li>2 CF card slots A (CF <b>A</b>) and B (CF <b>B</b>) (p. 34)</li> <li>3 CF card release buttons (p. 35)</li> <li>4 <b>POWER</b> switch (p. 24)</li> <li>5 ON/OFF indicator</li> <li>6 SLOT SELECT (CF card slot selection) button (p. 37)</li> <li>7 DISP. button (p. 42)/<br/>BATT. (battery information) button (p. 22)</li> <li>8 RESET button (p. 157)</li> <li>9 INDEX button (p. 109)/<br/>⏮ (review recording) button (p. 84)</li> <li>10  (white balance adjustment) button (p. 60)</li> </ul> | <ul style="list-style-type: none"> <li>11 WB (white balance) button (p. 59)</li> <li>12 CAMERA switch (p. 41)</li> <li>13 CF card slot cover switches for CF card slot A (CF <b>A</b>) and CF card slot B (CF <b>B</b>) (p. 34)</li> <li>14 SHUTTER button (p. 56)</li> <li>15 GAIN button (p. 54)</li> <li>16 IRIS button (p. 57)</li> <li>17 CUSTOM (customizable) dial (p. 46)</li> <li>18 AF/MF (autofocus/manual focus) button (p. 47, 49)</li> <li>19 Manual ring switch (p. 47, 57, 62)</li> <li>20 Manual ring (p. 47, 57, 62)</li> <li>21 Lens hood (p. 29)</li> </ul> |
|---|---|



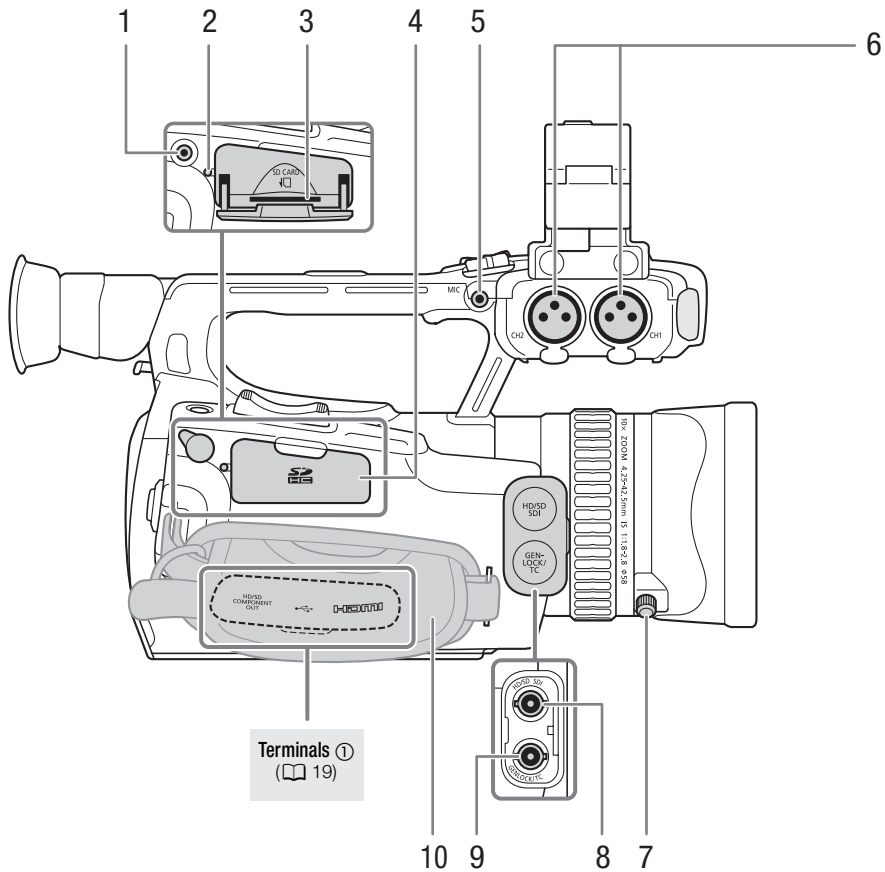

- 1 REMOTE terminal
- 2 SD card access indicator ( 36)
- 3 SD card slot ( 36)
- 4 SD card slot cover
- 5 MIC (microphone) terminal ( 74)
- 6 XLR terminals (CH1 and CH2) ( 75)
- 7 Lens hood lock screw ( 29)
- 8 **XF105** HD/SD SDI terminal ( 124)
- 9 **XF105** GENLOCK terminal ( 72) / TC (time code) terminal ( 72)
- 10 Grip belt ( 31)

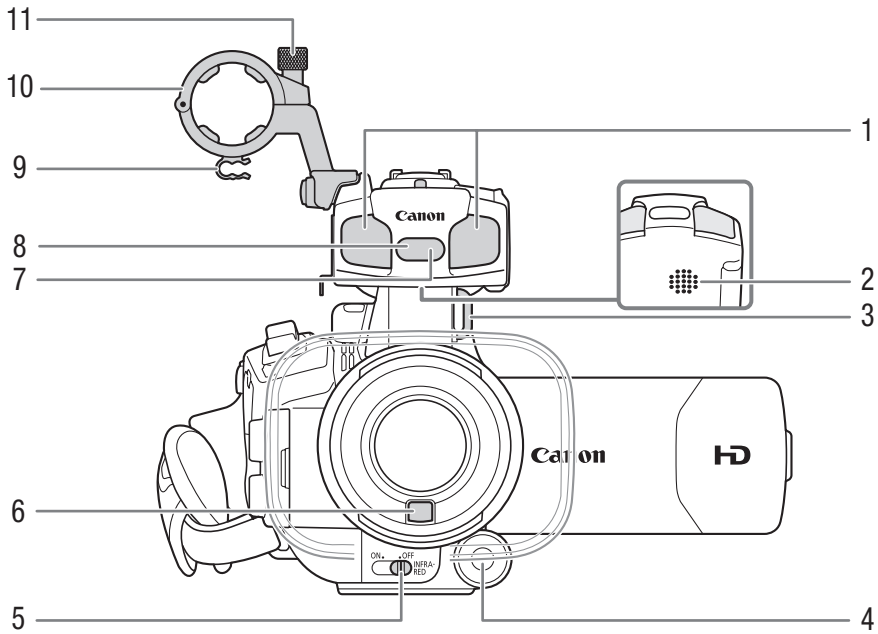

- 1 Built-in microphone (📖 74)
- 2 Built-in speaker (📖 112)
- 3 Strap mount (📖 31)
- 4 CUSTOM (customizable) button (📖 46)
- 5 INFRARED switch (📖 90)
- 6 Instant AF sensor (📖 49)
- 7 Remote sensor (📖 33)
- 8 Infrared light (📖 90)
- 9 Microphone cable clamp (📖 75)
- 10 Microphone holder unit (📖 75)
- 11 Microphone lock screw (📖 75)

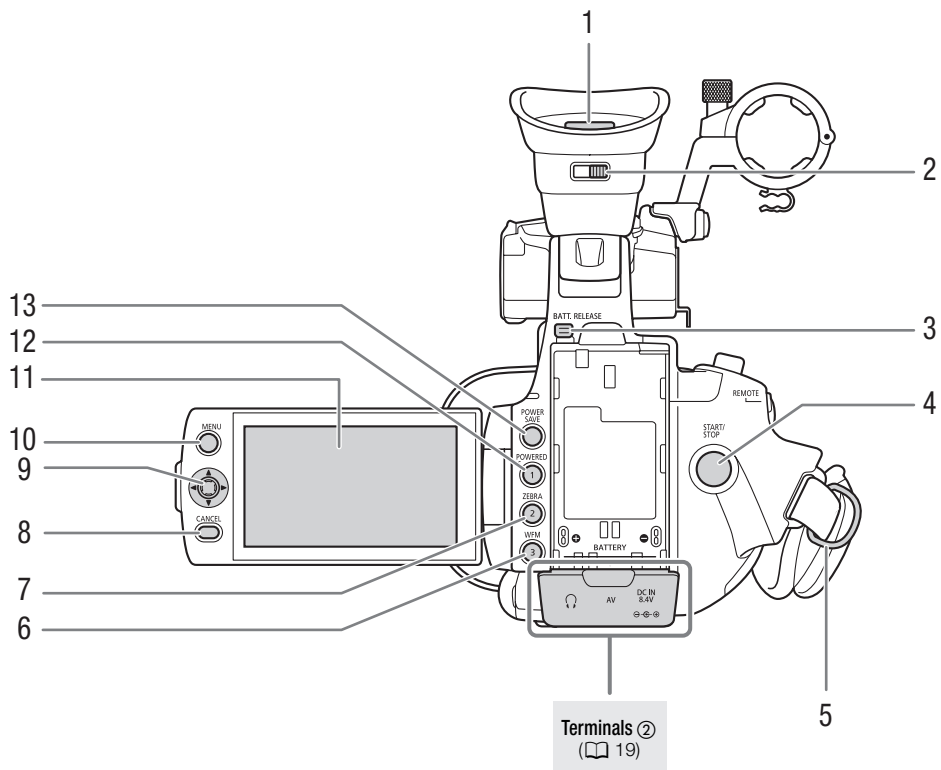

- 1 Viewfinder (19, 30)
- 2 Dioptic adjustment lever (29)
- 3 BATT. RELEASE (battery release) key (22)
- 4 START/STOP button (39)
- 5 Strap mount (31)
- 6 WFM (waveform monitor) button (81)/Assignable button 3 (94)
- 7 ZEBRA button (67)/Assignable button 2 (94)
- 8 CANCEL button (27)
- 9 Joystick (27)/SET button (27)
- 10 MENU button (27)
- 11 LCD screen (30)
- 12 POWERED IS button (52)/Assignable button 1 (94)
- 13 POWER SAVE button (44)

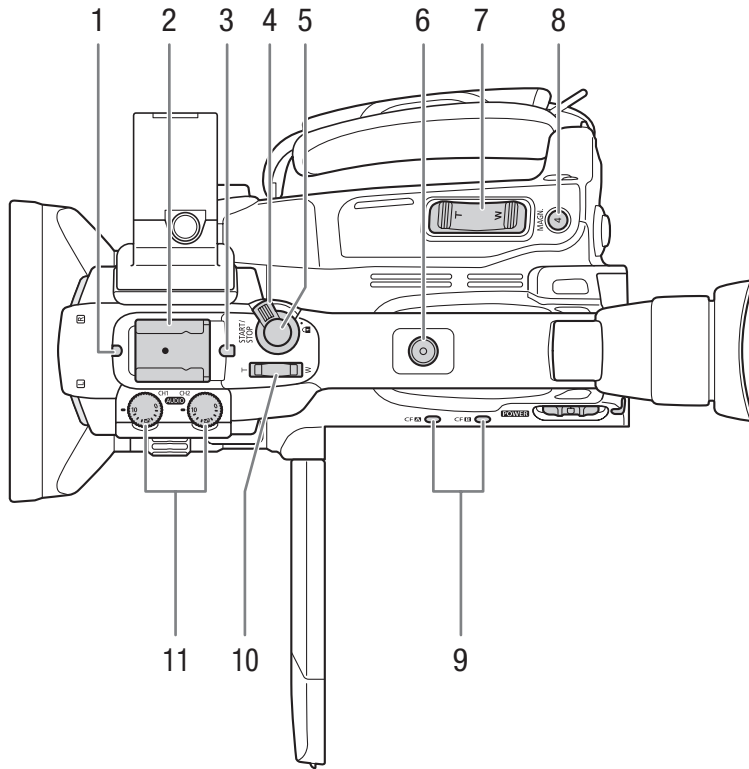

- 1 Front tally lamp (📖 39)
- 2 Accessory shoe  
For attaching accessories such as the optional VL-10Li II Battery Video Light.
- 3 Rear tally lamp (📖 39)
- 4 START/STOP lock lever (📖 40)
- 5 START/STOP button (📖 39)
- 6 Handle socket for 0.64 cm (1/4") screws
- 7 Grip zoom rocker (📖 63)
- 8 MAGN. (magnification) button (📖 49)/Assignable button 4 (📖 94)
- 9 CF card slot A (CF **A**) and CF card slot B (CF **B**) access indicators (📖 35)
- 10 Handle zoom rocker (📖 64)
- 11 Audio level dials for CH1 and CH2 (📖 78)

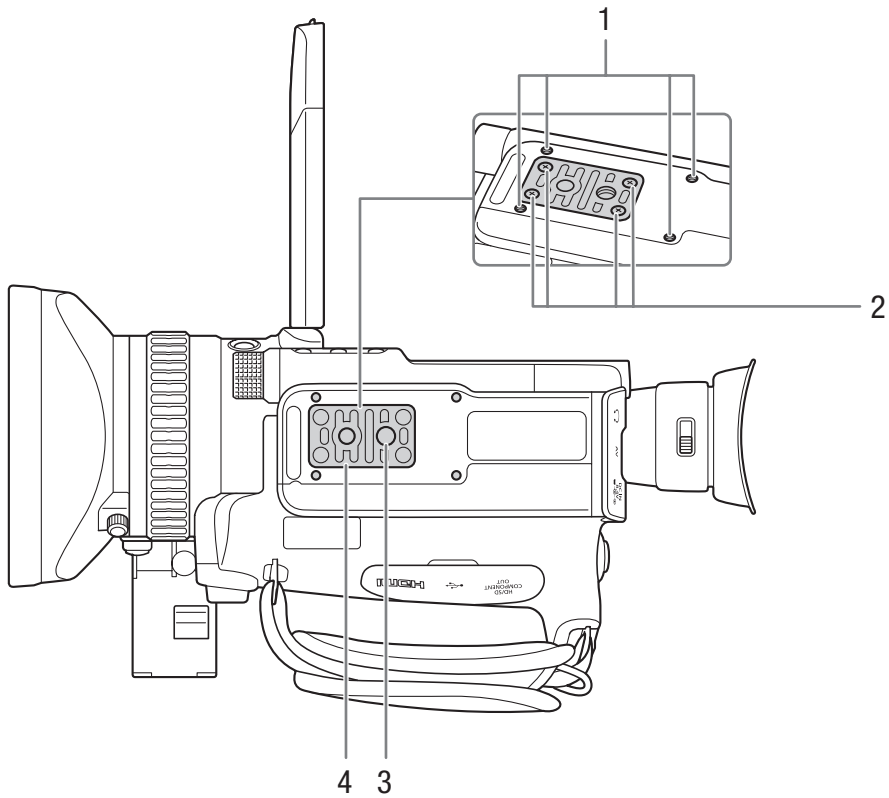

- 1 Attachment sockets for the optional TA-100 Tripod Adapter (📖 33)
- 2 Attachment screws for a tripod base (📖 33)
- 3 Tripod socket (📖 33)
- 4 Tripod base for tripods with 0.64 cm (1/4") screws (📖 33)

Operation panel ①

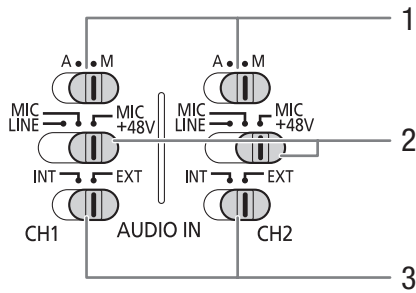

- 1 Audio level switches for CH1 and CH2 (📖 78)
- 2 XLR terminal switches for CH1 and CH2 (📖 76)
- 3 AUDIO IN switches for CH1 and CH2 (📖 74, 76)

Operation panel ②

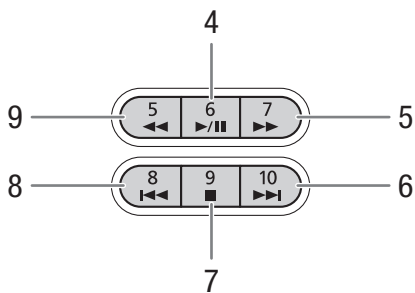

- 4 ▶/|| (play/pause) button (📖 109)/ Assignable button 6 (📖 94)
- 5 ▶▶ (fast playback) button (📖 111)/ Assignable button 7 (📖 94)
- 6 ▶▶| (skip forward) button (📖 111)/ Assignable button 10 (📖 94)
- 7 ■ (stop) button (📖 109)/ Assignable button 9 (📖 94)
- 8 ◀◀ (skip backward) button (📖 111)/ Assignable button 8 (📖 94)
- 9 ◀◀ (fast reverse playback) button (📖 111)/ Assignable button 5 (📖 94)

## Terminals ①

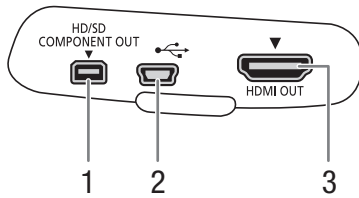

- 1 HD/SD COMPONENT OUT terminal (📖 124)
- 2 USB terminal
- 3 HDMI OUT terminal (📖 124)

## Terminals ②

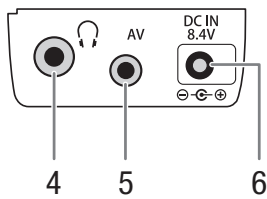

- 4 🎧 (headphone) terminal (📖 78)
- 5 AV terminal (📖 125)
- 6 DC IN terminal (📖 23)

## WL-D6000 Wireless Controller

20

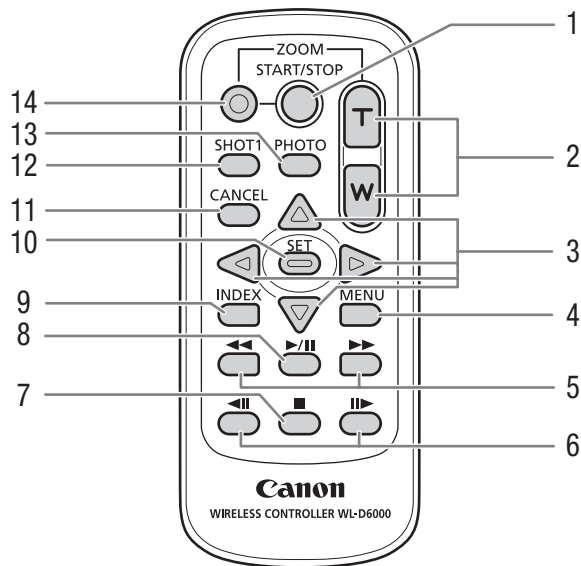

- 1 START/STOP button (📖 39)
- 2 ZOOM buttons (📖 65)
- 3 ▲/▼/◀/▶ buttons
- 4 MENU button (📖 27)
- 5 ◀◀/▶▶ (fast playback/reverse playback) buttons (📖 111)
- 6 ◀◻/◻▶ (frame forward/reverse) buttons (📖 111)
- 7 ■ (stop) button (📖 109)
- 8 ▶/◻ (play/pause) button (📖 109)
- 9 INDEX button (📖 109)
- 10 SET button (📖 27)
- 11 CANCEL button (📖 27)
- 12 SHOT1 (shot mark 1) button (📖 83)
- 13 PHOTO button (📖 132)
- 14 Record enable button: When you use the START/STOP button or ZOOM buttons, you must press this button simultaneously with the desired button.



## Preparing the Power Supply

You can power the camcorder using a battery pack or directly using the compact power adapter. If you connect the compact power adapter to the camcorder while a battery pack is attached, the camcorder will draw power from the power outlet.

Charge battery packs before use. For approximate charging times and recording/playback times with a fully charged battery pack, refer to *Charging Times* (□ 167) and *Recording and Playback Times* (□ 167).

### Using a Battery Pack

You can power the camcorder using the supplied BP-925 or optional BP-950G, BP-955, BP-970G or BP-975 Battery Pack. The BP-925, BP-955 and BP-975 Battery Packs are compatible with Intelligent System, meaning that you can check the remaining battery time even while the camcorder is turned off.

### Charging the Battery Pack

Charge battery packs using the supplied compact power adapter. Before charging, disconnect the DC cable from the compact power adapter and remove the terminal cover of the battery pack.

- 1 If the DC cable is connected to the compact power adapter, disconnect it.
  - If the DC cable is connected to the compact power adapter, charging will not start.
- 2 Connect the power cord to the compact power adapter (①).
- 3 Plug the power cord into a power outlet (②).
- 4 Attach the battery pack to the compact power adapter (③).
  - Press lightly and slide the battery pack in the direction of the arrow until it clicks.
  - The CHARGE indicator starts flashing and also indicates the battery pack's approximate charge. The indicator will stay on when charging has completed.

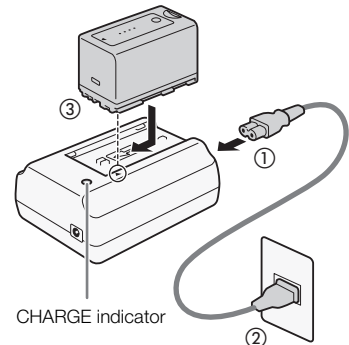

*.....*	0-34%: Flashes once per second
**.....**	35-69%: Flashes twice per second
***.....***	70-99%: Flashes 3 times per second

- 5 When charging has completed, remove the battery pack from the compact power adapter.
- 6 Unplug the power cord from the power outlet and disconnect it from the compact power adapter.

### **i** NOTES

- To charge the battery pack, disconnect the DC cable from the compact power adapter.

### Attaching the Battery Pack

- 1 Move the **POWER** switch to OFF (①).
- 2 Insert the battery pack all the way into the compartment and press gently until it clicks (②).

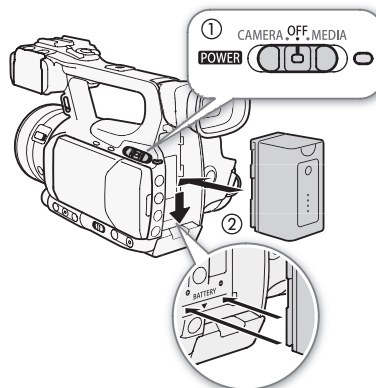

### Removing the Battery Pack

- 1 Move the **POWER** switch to OFF.
- 2 Hold down the BATT. RELEASE (battery release) key and remove the battery.

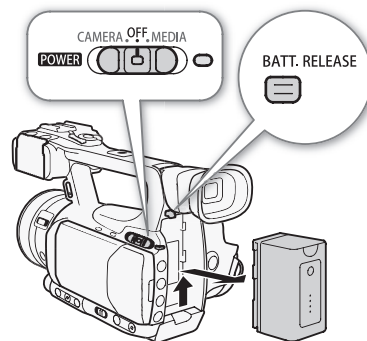

### Checking the Remaining Battery Charge

If you are using the supplied BP-925 or optional BP-955 or BP-975 Battery Pack, you can check the approximate remaining battery charge using one of the following methods when the camcorder is turned off. When the camcorder is turned on, you can check on the remaining battery charge by looking at any recording/playback screen or the [Battery / Hour Meter] status screen (154).

Press the CHECK button on the battery pack. An indicator will light for approximately 3 seconds and show the approximate remaining battery charge.

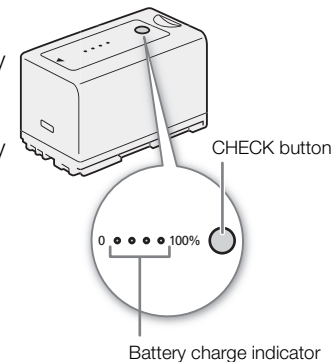

☼ ○ ○ ○	0-25%
☼ ☼ ○ ○	26-50%
☼ ☼ ☼ ○	51-75%
☼ ☼ ☼ ☼	76-100%

When the camcorder is off and an Intelligent System-compatible battery pack is attached, press the BATT. (battery information) button to display the remaining battery time and available recording time (displays for 5 seconds). Depending on the battery life, the battery information may not be displayed.

### ! IMPORTANT

- Do not connect to the compact power adapter any product that is not expressly recommended for use with this camcorder.

### i NOTES

- We recommend charging the battery pack in temperatures between 10 °C and 30 °C. Outside the temperature range of 0 °C to 40 °C, charging will not start.
- If there is a malfunction with the compact power adapter or battery pack, the charge indicator will go out and charging will stop.
- For handling precautions regarding the battery pack, refer to *Battery Pack* (162).
- Charged battery packs continue to discharge naturally. Therefore, charge them on the day of use, or the day before, to ensure a full charge.
- We recommend that you prepare battery packs to last 2 to 3 times longer than you think you might need.
- The first time you use a battery pack, fully charge it and then use the camcorder until the battery pack is completely exhausted. Doing so will ensure that the remaining recording time will be displayed accurately.
- Repeatedly charging and discharging the battery pack will eventually shorten its battery life. When you are using the supplied BP-925 or optional BP-955 or BP-975 Battery Pack, you can check the battery life on the [Battery / Hour Meter] status screen (154) or the battery information screen (press the BATT. button while the camcorder is turned off). Fully charging the battery pack and then discharging it will give you a more accurate reading.

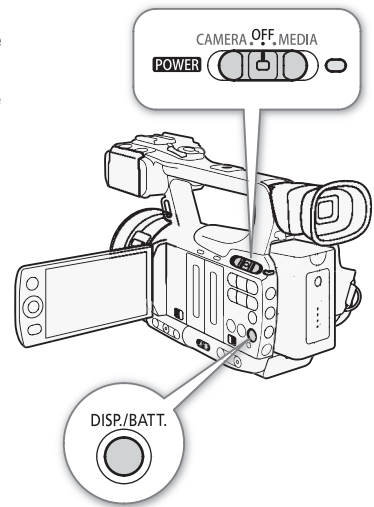

## Using a Household Power Outlet

When Using the Supplied CA-930 Compact Power Adapter and DC-930 DC Cable:

- Move the **POWER** switch to OFF (1).
- Connect the DC cable to the DC IN terminal on the camcorder (2).
- Connect the power cord to the compact power adapter and plug it into a power outlet (3).
- Connect the DC cable to the compact power adapter (4).

### ! IMPORTANT

- Turn off the camcorder before connecting or disconnecting the compact power adapter.

### i NOTES

- When using the camcorder with a household power outlet, you can change the battery pack while the power is on.

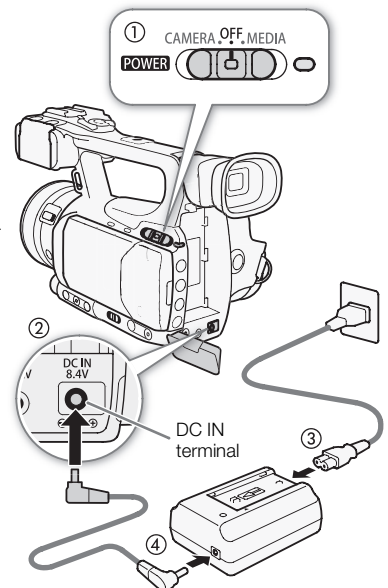

### When Using the Optional CA-920 Compact Power Adapter and DC-920 DC Coupler:

- 1 Move the **POWER** switch to OFF (①).
- 2 Attach the DC coupler to the camcorder (②).
- 3 Connect the power cord to the compact power adapter and plug it into a power outlet (③).
- 4 Connect the DC coupler to the adapter (④).
- 5 Detach the DC coupler after use.
  - Push the BATT. RELEASE key and pull out the DC coupler.

#### ! IMPORTANT

- Turn off the camcorder before connecting or disconnecting the compact power adapter.

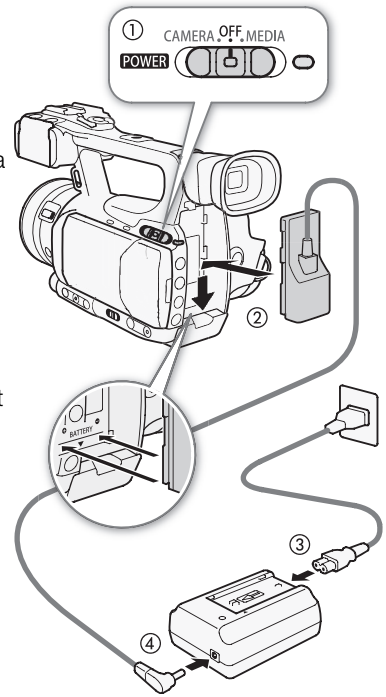

### Turning the Camcorder On and Off

The camcorder has two operating modes: CAMERA (CAMERA) mode for making recordings and MEDIA (MEDIA) mode for playing back recordings. Select the operating mode using the **POWER** switch.

#### To turn on the camcorder

Hold down the button on the **POWER** switch and move it to CAMERA for CAMERA mode or MEDIA for MEDIA mode. The ON/OFF indicator will illuminate in green.



CAMERA mode



MEDIA mode

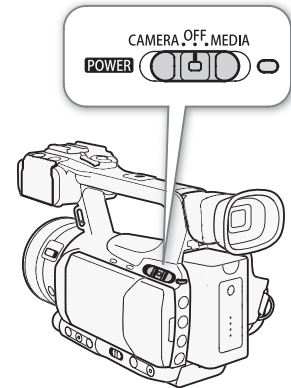

#### To turn off the camcorder

Move the **POWER** switch to OFF. The ON/OFF indicator will turn off.



## Date, Time and Language Settings

### Setting the Date and Time



You will need to set the date and time of the camcorder before you can start using it. When the camcorder's clock is not set, the [Date/Time] screen will appear automatically with the day selected.

Operating modes:



- 1 Push the joystick up/down to change the day then move (▶) to the month.
- 2 Change the rest of the fields in the same way.
- 3 Select (▶) [Set] and then press SET to start the clock and close the screen.

#### NOTES

- When the built-in rechargeable lithium battery is exhausted, the date and time setting may be lost. In such case, recharge the built-in lithium battery (📖 164) and set the time zone, date and time again.
- You can change the date format and the clock format (12/24 hours) with the [ Other Functions] ⌂ [Clock Set] ⌂ [Date Format] setting.
- You can also change the date and time later on (not during the initial setup) with the [ Other Functions] ⌂ [Clock Set] ⌂ [Date/Time] setting.

### Changing the Time Zone

Change the time zone to match the time zone of your location. The default setting is [UTC+01:00 Central Europe]. The time zones are based on Coordinated Universal Time (UTC).

Operating modes:

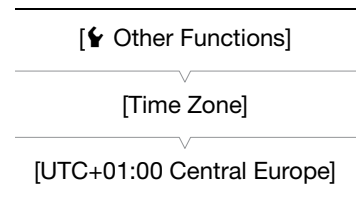

- 1 Press the MENU button.
- 2 Push the joystick up/down to select [ Other Functions] and then press SET.
- 3 Select [Time Zone] in a similar fashion.
- 4 Push the joystick up/down to change the time zone.
- 5 Press SET to set the time zone and then press the MENU button to close the menu.

## Displaying the Date and Time while Recording

You can display the date and time in the lower left of the screen.

26

Operating modes: CAMERA MEDIA

- 1 Press the MENU button.
- 2 Push the joystick up/down to select [ LCD/VF Setup].
- 3 Select [Custom Display 2] and then [Date/Time] in a similar fashion.
- 4 Push the joystick up/down to select the information to display.
  - Select [Off] to record without displaying the date and time.
- 5 Press SET and then press the MENU button to close the menu.

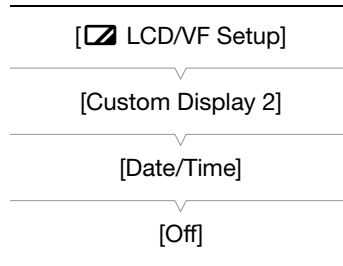

## Changing the Language

You can change the language in which onscreen messages are displayed. The default language is English but you can select German, Spanish, French, Italian, Polish, Russian, Simplified Chinese, Korean or Japanese.

Operating modes: CAMERA MEDIA

- 1 Press the MENU button.
- 2 Push the joystick up/down to select [ Other Functions].
- 3 Select [Language ] in a similar fashion.
- 4 Use the joystick to select a language.
- 5 Press SET to select the language and then press the MENU button to close the menu.

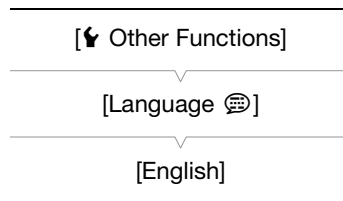

## Using the Menus

In **CAMERA** mode, many of the camcorder's functions can be adjusted from the menu for general settings, which opens after pressing the MENU button. In **MEDIA** mode, press the MENU button to open the menu for general settings or SET to open the clip menu for clip operations. For details about the available menu options and settings, refer to *Menu Options* (139).

Operating modes: **CAMERA** **MEDIA**

### MENU button

Press to open the menu and then press again to close the menu after adjusting desired settings.

### Joystick/SET button

Push the joystick to move the orange selection frame in the menu. Then, press the joystick itself (SET button) to select the menu item indicated by the orange selection frame.

### CANCEL button

Press to return to the previous menu or to stop some operations that are in progress.

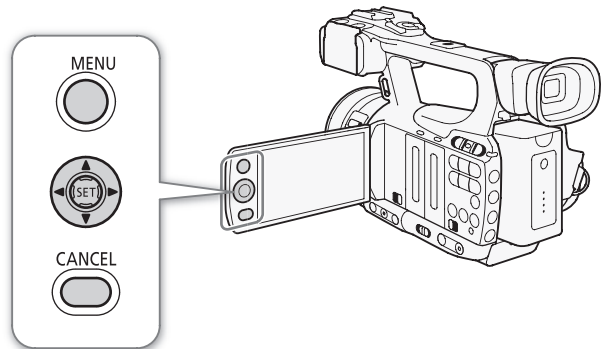

## Selecting an Option from the Menu

The following is a step-by-step explanation of how to select an option from the menu. In the procedures throughout the rest of this manual, opening and closing the menu is assumed and not included in the procedure.

### 1 Press the MENU button.

- The menu opens with the orange selection frame indicating the menu item that was selected the previous time the menu was closed (unless the camcorder was turned off).

### 2 Push the joystick up/down to select the desired submenu.

### 3 Push the joystick right or press SET.

- The orange selection frame will appear on a menu item in the submenu.
- Press the CANCEL button, push the joystick left, or select [↶] to return to the previous submenu.

### 4 Push the joystick up/down to select the desired menu item.

- If a submenu contains many menu items, a scroll bar will appear on the right side of the submenu indicating that you must scroll up or down to see other menu items.
- A ► mark next to a menu item indicates another submenu. Repeat steps 3 and 4.

### 5 Push the joystick right or press SET.





- The orange selection frame will appear on a setting option.
- Press the CANCEL button to return to the previous submenu.

### 6 Push the joystick up/down to select the desired setting option and then press SET.

- Depending on the menu item, additional selections may be necessary.

### 7 Press the MENU button to close the menu.

 NOTES

- Unavailable items may appear grayed out.
- Pressing the MENU button at any time closes the menu.
- When using the wireless controller, use the , , ,  and SET buttons in the same way as the camcorder's joystick.
- You can check the current settings on the status screens ( 150).



## Preparing the Camcorder

This section outlines the basic preparations for the camcorder such as attaching the lens hood, attaching the microphone holder unit, and adjusting the viewfinder and LCD screen.

### Attaching the Microphone Holder Unit

Use the supplied screws to attach the microphone holder unit to the handle.

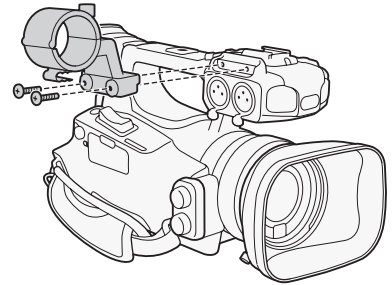

### Attaching the Lens Hood

Attach the lens hood to protect the lens and reduce the amount of stray light that may hit the lens.

1 Place the lens hood on the front of the lens (①) and turn it 90 degrees clockwise (②).

- Be careful not to deform the lens hood.
- Make sure that the lens hood is aligned with the thread.

2 Tighten the lock screw (③).

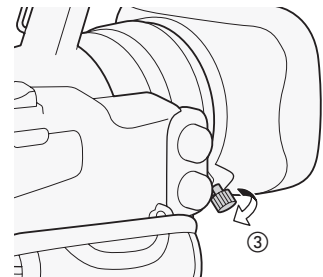
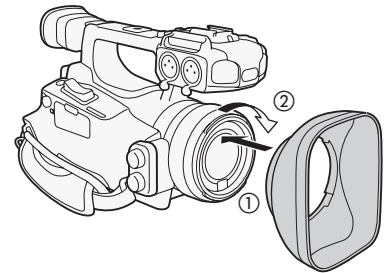

### Dioptric Adjustment

Turn on the camcorder and adjust the dioptic adjustment lever.

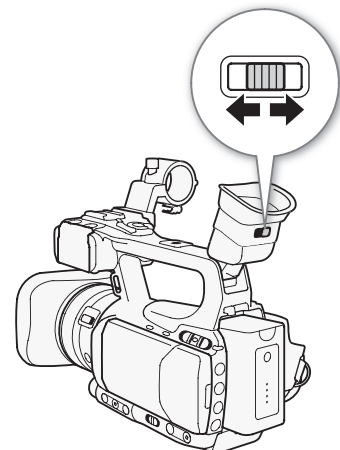

## Using the LCD Panel

Open the LCD panel 90 degrees.

- You can rotate the panel 90 degrees downward or 180 degrees toward the lens.

### NOTES

- By default, the viewfinder screen is turned off while you use the LCD screen. However, you can also use both displays simultaneously. See the following section.
- You can set the LCD screen to black & white (📖 31).
- When you use a commercially available lens adapter and the image on the screen is inverted, you can use the [ Other Functions] ➤ [Custom Function] ➤ [Scan Reverse Rec] setting to return the image to the correct orientation.

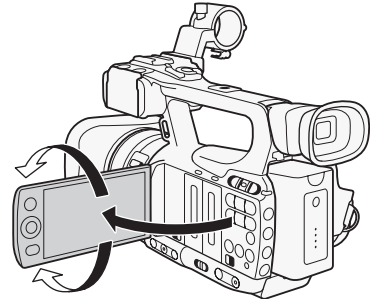

## Using the Viewfinder and LCD Screen Simultaneously

By default, the viewfinder screen is turned off while you use the LCD screen. Follow the procedure below to use both of them simultaneously.

Operating modes: CAMERA MEDIA

- 1 Open the [LCD/VF Simul.] submenu.  
[ LCD/VF Setup] ➤ [LCD/VF Simul.]
- 2 Select [On] and then press SET.

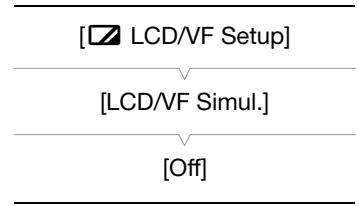

## Adjusting the Viewfinder/LCD Screen

You can adjust the brightness, contrast, color, sharpness\*, and backlight of the viewfinder and LCD screen independently of each other. These adjustments will not affect your recordings.

\* The viewfinder's sharpness cannot be adjusted.

Operating modes: CAMERA MEDIA

- 1 Open the setup menu for the viewfinder or LCD screen.  
[ LCD/VF Setup] ➤ [LCD Setup] or [VF Setup]
- 2 Select [Brightness], [Contrast], [Color], [Sharpness] or [Backlight] and then press SET.
- 3 Adjust the setting and then press SET.
  - Repeat steps 2 and 3 to adjust other settings as necessary.

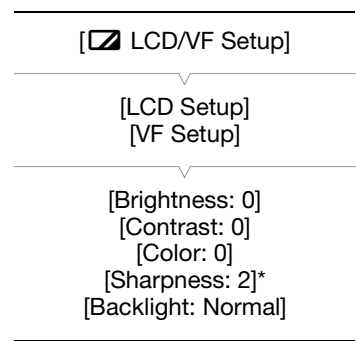

\* The viewfinder's sharpness cannot be adjusted.

### NOTES

- If you set an assignable button to [LCD Setup] (📖 94), you can press the button to open the [LCD Setup] submenu.

## Setting the Screen to Black & White

The viewfinder and LCD screen display in color by default but you can set them to black & white. Even when the screen is black & white, onscreen text and icons will still be displayed in color.

Operating modes: CAMERA MEDIA

- 1 Open the [LCD/VF B&W] submenu.  
[ LCD/VF Setup]  $\odot$  [LCD/VF B&W]
- 2 Select [On] and then press SET.

### NOTES

- You can also set the screen to black & white by setting an assignable button to [LCD/VF B&W] ( 94).

## Adjusting the Grip Belt

Adjust the grip belt so that you can reach the grip zoom rocker with your index and middle fingers, and the START/STOP button with your thumb.

### IMPORTANT

- Be careful not to drop the camcorder when adjusting the grip belt.

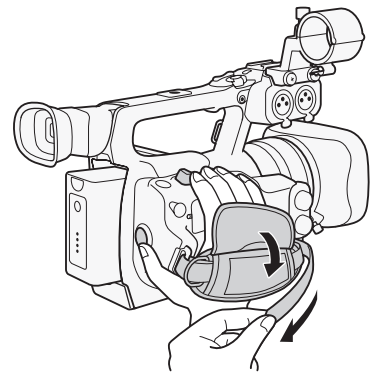

## Attaching a Shoulder Strap

Pass the ends through the strap mount and adjust the length of the strap.

### IMPORTANT

- Be careful not to drop the camcorder when attaching or adjusting the shoulder strap.

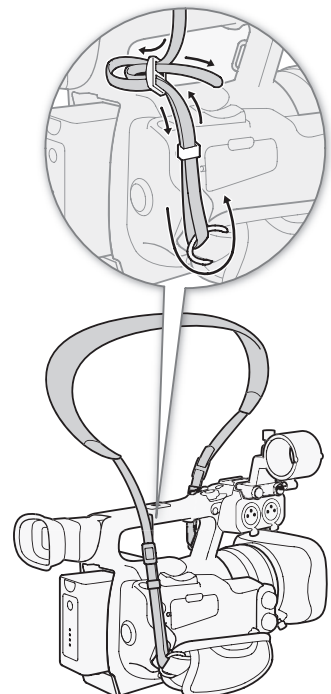

[ LCD/VF Setup]

[LCD/VF B&W]

[Off]

### Removing and Attaching the Terminal Covers

Remove the covers for the following terminals in order to access them.

- HD/SD SDI and GENLOCK/TC terminals\*
- HD/SD COMPONENT OUT, USB and HDMI OUT terminals
- (headphone), AV and DC IN terminals
- REMOTE terminal

\* **XF105** only.

#### Removing the Terminal Covers

- 1 Open the terminal cover.
- 2 Grasp the strip connecting the terminal cover to the camcorder and pull straight out.

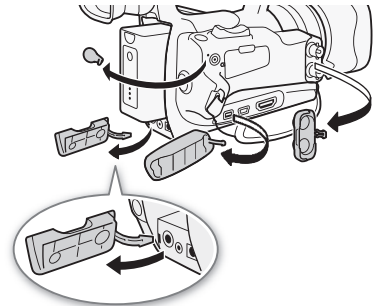

#### Attaching the Terminal Covers

Insert the connecting strip into the opening to attach the terminal cover.

#### **i** NOTES

- If the connecting strip is difficult to grasp, use a pair of tweezers or similar tool.

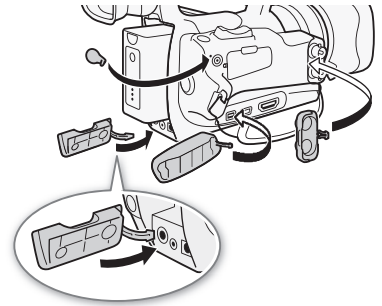

### Using the Wireless Controller

#### Inserting the Battery

Insert the supplied CR2025 lithium button battery into the wireless controller before use.

- 1 Press the tab in the direction of the arrow (1) and pull out the battery holder (2).
- 2 Place the lithium button battery with the + side facing up (3).
- 3 Insert the battery holder (4).

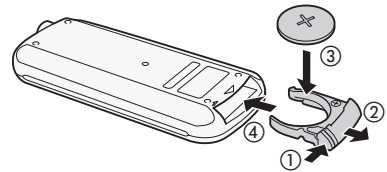

#### Activating the Wireless Controller

By default, the wireless controller is activated. If it has been deactivated, follow the procedure below to activate it.

Operating modes: **CAMERA** **MEDIA**

- 1 Open the [Wireless Controller] submenu.  
[Other Functions] ● [Wireless Controller]
- 2 Select [On] and then press SET.

#### **i** NOTES

- You can also activate the wireless controller by setting an assignable button to [Wireless Controller] (94).

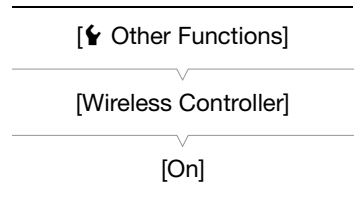

## Using the Wireless Controller to Operate the Camcorder

When using the wireless controller, point it at the camcorder's remote sensor. When the wireless controller's buttons are operated, the camcorder's tally lamps will illuminate.

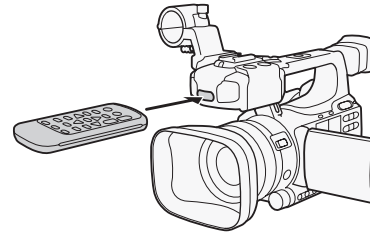

### **i** NOTES

- When you use the START/STOP button or ZOOM buttons on the wireless controller, you must press the record enable button simultaneously with the desired button.
- When the camcorder cannot be operated with the wireless controller, or when it can only be operated at very close range, replace the battery.
- The wireless controller may not work properly when the remote sensor is located under strong light sources or direct sunlight.

## Using a Tripod

You can mount the camcorder on a tripod but do not use tripods with mounting screws longer than 5.5 mm as this may cause damage to the camcorder.



### Using a Tripod with 0.95 cm (3/8") Mounting Screws

To use a tripod with 0.95 cm (3/8") mounting screws, first attach the optional TB-1 Tripod Adapter Base to the camcorder and then attach the tripod to the adapter base.

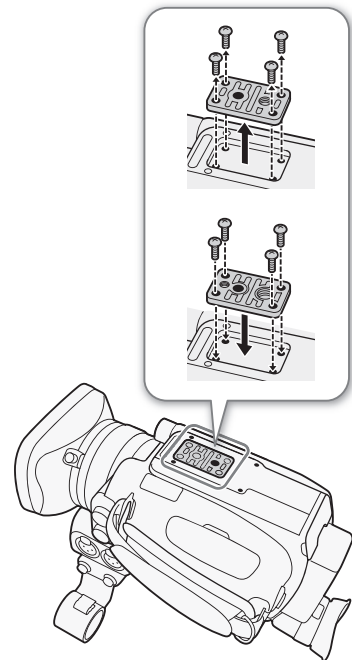
- 1 Remove the tripod base from the camcorder.
  - Remove the 4 screws and then remove the base.
- 2 Attach the optional TB-1 Tripod Adapter Base.
  - Firmly screw in the 4 screws.
- 3 Attach the tripod.
  - Firmly screw in the tripod screw.
  - If a tripod has both a 0.64 cm (1/4") screw and 0.95 cm (3/8") mounting screw, firmly screw in both.



## Preparing Recording Media

The camcorder records clips to  CompactFlash (CF) cards and photos\* to  SD and  SDHC memory cards. The camcorder is equipped with two CF card slots. Initialize recording media ( [book 36](#) ) when you use them with this camcorder for the first time.

\* The camcorder can record custom picture settings ( [book 98](#) ) and camera settings ( [book 106](#) ) on to an SD card. To record a user memo ( [book 79](#) ) with a clip, use the **Canon XF Utility** software ( [book 128](#) ) to a create user memo file and save it to the SD card. The camcorder can read the file and embed it in the clip.

### Compatible CF cards

You can use UDMA-compatible\* Type I CF cards with a capacity of at least 512 MB with the camcorder. For more details on cards that can be used, visit your local Canon Web site.

\* The Ultra Direct Memory Access (UDMA) specification allows data to be transferred between the CF card and device at high transfer speeds (measured in MBps). Depending on the CF card, you may not be able to record even when using a UDMA-compatible CF card.

### IMPORTANT

- **About high capacity CF cards** You can use CF cards with a capacity of 128 GB or larger with this camcorder but such CF cards are initialized using the exFAT file system.
  - When using exFAT-formatted CF cards with other devices (digital recorders, card readers, etc.), make sure that the external device is compatible with exFAT. For more information on compatibility, contact the computer, operating system or memory card manufacturer.
  - If you use exFAT-formatted CF cards with a computer OS that is not exFAT-compatible, you may be prompted to format the CF card. In such case, **cancel the operation to prevent data loss**.

### NOTES

- Proper operation cannot be guaranteed for all CF cards.

### Inserting a CF Card

You can insert a CF card into CF card slot A or slot B. If you have two CF cards, you can use both slots.

1 Slide the CF card slot cover switch in the direction of the  mark (1).

- The CF card slot cover will open to the left (slot A) or to the right (slot B).

2 Insert the CF card straight, with the label facing away from the lens, all the way into the slot until it clicks (2).

3 Close the CF card slot cover.

- Do not force the cover closed if the CF card is not correctly inserted.

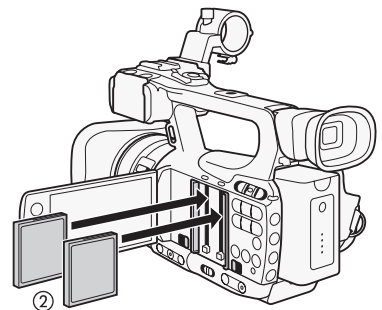
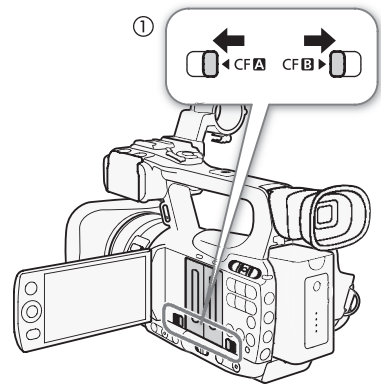

## Checking the Status of the CF Card Slots

You can check the status of the CF card slots immediately by looking at the CF **A**/CF **B** access indicator. Refer to the following table.

Access indicator color	CF card slot status
Red	Accessing CF card.
Green	Recording/playback is possible and the CF card slot is selected for recording/playback.
Indicator off	A CF card is not inserted, the CF card slot is not currently selected, or the CF card is not being accessed.

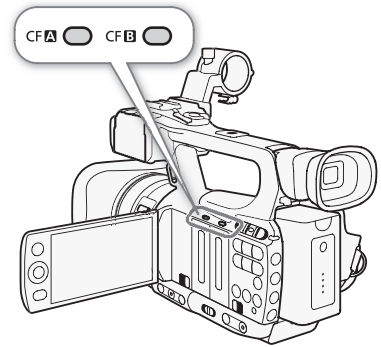

## Removing a CF card

- 1 Wait until the access indicator for the card slot with the CF card to be removed is off (①).
- 2 Slide the CF card slot cover switch in the direction of the ◀/▶ mark (②).
  - The CF card slot cover will open to the left (slot A) or to the right (slot B).
- 3 Push the CF card release button (③).
  - The release button partially pops out.
- 4 Push in the CF card release button to release the CF card (④).
- 5 Pull the CF card all the way out and close the CF card slot cover.

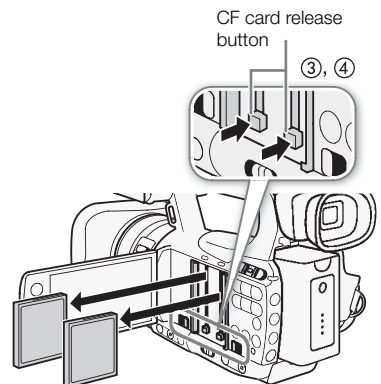
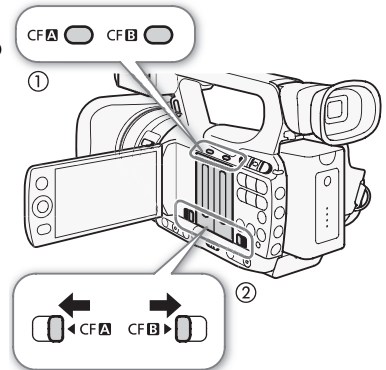

### ! IMPORTANT

- Observe the following precautions while the CF **A** or CF **B** access indicator is illuminated in red. Failure to do so may result in permanent data loss.
  - Do not disconnect the power source or turn off the camcorder.
  - Do not open the cover of the CF card slot being accessed.

### i NOTES

- If you set the [Other Functions] ▶ [Media Access LED] function to [Off], the access indicators will not illuminate.

## Inserting and Removing an SD Card

- 1 Turn off the camcorder (①).
- 2 Open the SD card slot cover.
- 3 Insert the SD card straight, with the label facing the grip belt, all the way into the SD card slot until it clicks (②).
- 4 Close the SD card slot cover (③).
  - Do not force the cover closed if the SD card is not correctly inserted.

### ! IMPORTANT

- Observe the following precautions while the SD card access indicator is flashing. Failure to do so may result in permanent data loss.
  - Do not disconnect the power source or turn off the camcorder.
  - Do not remove the SD card.
- Turn off the camcorder before inserting or removing an SD card. Inserting or removing the SD card with the camcorder on may result in permanent data loss.
- SD cards have front and back sides that are not interchangeable. Inserting an SD card facing the wrong direction can cause a malfunction of the camcorder. Be sure to insert the SD card as described in step 3.

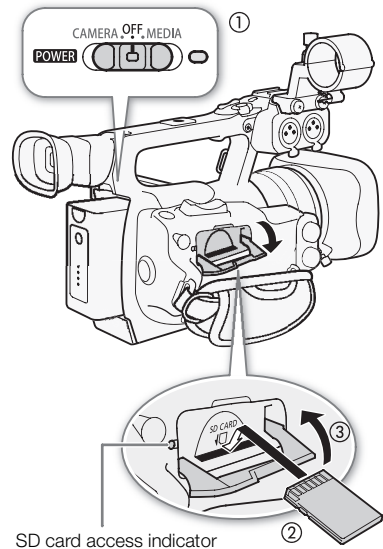

### i NOTES

- **To remove the SD card:** Push the SD card once to release it. When the SD card springs out, pull it all the way out.
- If you set the [Other Functions] [Media Access LED] function to [Off], the access indicators will not illuminate.

## Initializing the Recording Media

The first time you use any recording media with this camcorder, initialize it first. You can also initialize a recording media to permanently delete all the data it contains.

When initializing an SD card, you can select quick initialization, which clears the file allocation table but does not physically erase the stored data, or complete initialization, which deletes all data completely.

Operating modes: CAMERA MEDIA

- 1 Open the [Initialize Media] submenu.  
[Other Functions] [Initialize Media]
- 2 Select [CF A], [CF B] or [SD Card] and then press SET.

### To initialize a CF card

- 3 Select [OK] and then press SET.
- 4 When the confirmation message appears, press SET.
  - The CF card is initialized and all the data it contains is erased.

### To initialize an SD card

- 3 Select [Complete] (complete initialization) or [Quick] (quick initialization) and then press SET.

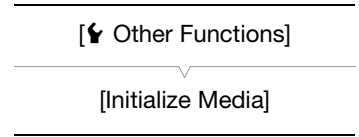



#### 4 Select [OK] and then press SET.

- If you are using the [Complete] initialization option, press SET to cancel the operation while it is in progress. You can use the SD card but all data will be erased.

#### 5 When the confirmation message appears, press SET.

- The SD card is initialized and all the data it contains is erased.

#### ! IMPORTANT

- Initializing the recording media will permanently erase all data, including clips with an **OK** mark, protected photos, and custom picture information. Lost data cannot be recovered. Make sure you save important recordings in advance.
- Depending on the SD card, the complete initialization may take up to a few minutes.

#### i NOTES

- While recording on a CF card, you can initialize another CF card in the other CF card slot.

### Switching Between the CF Card Slots

The camcorder features two CF card slots, CF card slot A (CF **A**) and CF card slot B (CF **B**). If both slots contain a CF card, you can switch between them as necessary.

Operating modes: **CAMERA** **MEDIA**

Press the **SLOT SELECT** button.

- The access indicator of the selected CF card slot will illuminate in green.

#### i NOTES

- If both CF card slots contain a CF card and you open the cover of the selected slot, the camcorder will automatically switch to the other slot.
- You cannot use the **SLOT SELECT** button to switch between CF card slots while recording.

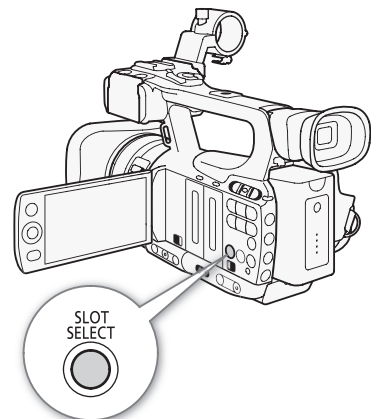

### Selecting the CF Card Recording Method

The camcorder features two useful CF card recording methods, relay recording and double slot recording.

**Relay recording:** This allows you to continue recording on another CF card without interruption if the CF card you are using becomes full. Relay recording is available from CF card slot A to CF card slot B, and vice versa.

**Double slot recording:** This records the same clip simultaneously to both CF cards, which is a convenient way to make a backup copy of your recording while you record.

Operating modes: **CAMERA** **MEDIA**

**To use relay recording**

By default, this function is activated. If it has been deactivated, follow the procedure below to activate it.

- 1 Open the [Relay Rec] submenu.  
 [👉 Other Functions] ● [Relay Rec]
- 2 Select [On] and then press SET.

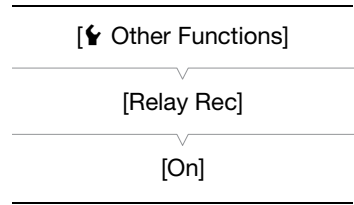

**To use double slot recording**

- 1 Open the [Double Slot Rec] submenu.  
 [👉 Other Functions] ● [Double Slot Rec]
- 2 Select [On] and then press SET.

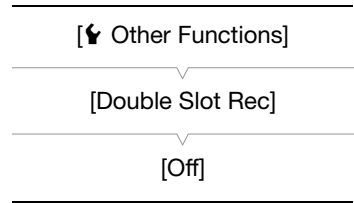

**i NOTES**

- When the bit rate is set to 50 Mbps (📖 45) during slow motion recording, relay recording is not available.
- If a CF card becomes full during double slot recording, recording on both cards will stop. On the other hand, if an error occurs with one of the cards, recording will continue on the other card.
- Double slot recording cannot be used with relay recording or slow & fast motion recording.

**Checking the Available Recording Time**

When the camcorder is in **CAMERA** mode, the screen indicates which CF card slot is in use and the available recording time (in minutes\*) that remains on each CF card.

On the [Media] status screen (📖 152), you can check the available recording time, total space and used space of each recording media, and the available number of photos.

\* The approximate available recording time is based on the current bit rate.

**Recovering Data on the CF Card**

An error may occur with data on the CF card in cases such as turning off the camcorder while recording or removing the CF card while recording. In such case, you may be able to recover the data on the CF card.

Operating modes: **CAMERA** **MEDIA**

- 1 Insert the CF card with the data to be recovered into the camcorder.
- 2 When the screen prompts you to recover the data, select [OK] and then press SET.
- 3 After a message appears indicating that the data has been recovered, press SET.

**i NOTES**

- This procedure will delete clips shorter than 10 seconds in length. Additionally, up to 10 seconds will be deleted from the end of clips on the CF card.
- In some cases, data may not be recovered, such as when the FAT32 file system is corrupted or the CF card is physically damaged.
- While you are recording, you can recover data on the CF card that is not being recorded to.

## Recording Video

This section explains the recording basics. Before you begin recording, make a test recording first to check if the camcorder operates correctly. Record for approximately 6 minutes at 50 Mbps ( 34). Should the camcorder fail to operate correctly, refer to *Troubleshooting* ( 156).

For details on recording audio, refer to *Recording Audio* ( 74).

Operating modes: **CAMERA** **MEDIA**

### Preparing to Record

- 1 Attach a charged battery pack to the camcorder ( 22).
- 2 Insert a CF card into a CF card slot ( 34).
  - Insert another CF card into the other CF card slot to use relay recording ( 38) or double slot recording ( 38).
- 3 Remove the lens cap.
- 4 Adjust the viewfinder.

#### **i** NOTES

- The camcorder can add a user memo ( 79) to a clip as you record. It can be used to store information such as the clip name, camera operator and filming location. However, you must set the user memo before recording.
- You can attach commercially available accessories to the handle by using the socket for 0.64 cm (1/4") mounting screws.

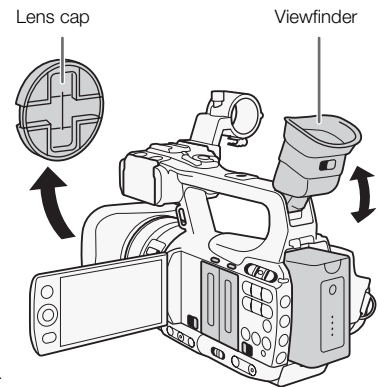

### Recording

- 1 Hold down the button on the **POWER** switch and move it to **CAMERA**.
  - The camcorder turns on in **CAMERA** mode and enters record pause mode.
  - The access indicator for the CF card slot selected for recording illuminates in red and then changes to green.

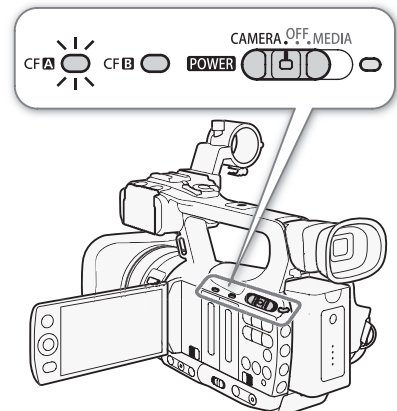

## 2 Press the START/STOP button to begin recording.

- Recording starts. The front and rear tally lamps illuminate and the recording indicator [●REC] appears on the screen.
- You can use the START/STOP button on the side grip or handle.
- When you use the wireless controller, press the START/STOP button and the record enable button simultaneously.

## 3 Press the START/STOP button to pause the recording.











- The clip\* is recorded to the CF card and the camcorder enters record pause mode. The tally lamps will also go out.

\* "Clip" refers to one movie unit from the point you press the START/STOP button to start recording until you press again to pause the recording. You can also include custom picture settings (📖 96) and metadata (📖 79) with the clip.

### ! IMPORTANT

- Observe the following precautions while the CF **A** or CF **B** access indicator is illuminated in red. Failure to do so may result in permanent data loss.
  - Do not open the CF card slot cover of the CF card slot being accessed and remove the CF card.
  - Do not disconnect the power source or turn off the camcorder.
- Be sure to save your recordings regularly (📖 128), especially after making important recordings. Canon shall not be liable for any loss or corruption of data.

### i NOTES

- The START/STOP button on the handle has a lock lever to prevent accidental operation. Set the lock lever to  in cases such as when you do not want a recording inadvertently paused or do not plan to use the START/STOP button. Return the lever to its previous position to enable use of the START/STOP button again.
- You can use the [ Other Functions]  [Rec Review] setting (📖 84) to review the last clip recorded.
- If you set an assignable button to [Add  Mark] or [Add  Mark] (📖 94), you can press the button to add an  mark or  mark to the last clip recorded.
- You can use the [ Other Functions]  [Clips]  [Delete Last Clip] setting (📖 147) to delete the last clip recorded. Alternatively, you can set an assignable button to [Delete Last Clip]. However, you cannot delete the last clip if double slot recording is on.
- **XF105** When you set the [ Other Functions]  [SDI Rec Command] setting to [On] and you connect the camcorder to another device using the HD/SD SDI terminal, if you start or stop recording with the camcorder, the other device will also start or stop recording. For more details, visit your local Canon Web site.
- The area around the tripod base may become hot after using the camcorder for an extended period of time. This is not a malfunction.

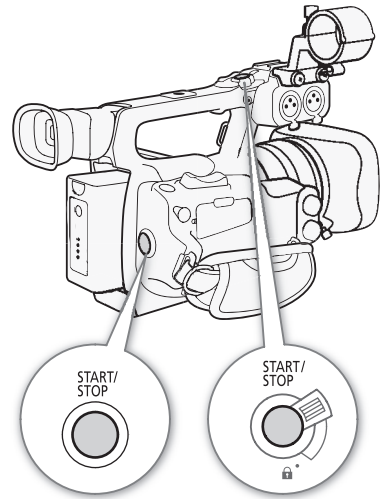



### Recording in Full Auto Mode



Move the CAMERA switch to FULL AUTO to change the camcorder to full auto mode. In full auto mode, the camcorder automatically sets the iris, gain, shutter speed, and white balance. The camcorder will continuously adjust the brightness and white balance automatically\*. In full auto mode, however, the autofocus will not be turned on.

\* The light metering mode (☞ 58) will be set to [Standard], the AE level (☞ 58) will be set to [±0] and the AGC limit (☞ 53) will be set to [Off/24 dB].

### Locking Buttons

Moving the CAMERA switch to  will lock the following buttons: IRIS, GAIN, SHUTTER, WB, , AF/MF. Doing so will also lock the settings of the corresponding functions. This is useful in preventing settings from being changed due to inadvertently pressing one of the buttons.

### About Clips

When the camcorder records a clip, it also assigns a 6-character clip name consisting of a 2-letter prefix and 4 numerals (for example, "AA0001"). The numerals increase every time a clip is recorded. You can set the initial clip name in advance using the [ Other Functions]  [Clips]  [Title Prefix] and [Number Setting] settings. You cannot change the clip name after the clip is recorded.

The video file (stream) in a clip will be split approximately every 2 GB for clips with a long recording time. Even in such case, playback will be continuous.

### NOTES

- If you are recording with two CF cards and the CF card you are using becomes full while recording, the clip will continue uninterrupted on the other CF card when relay recording (☞ 38) is activated. In such case, the recording will be recorded as separate clips.
- If you record using the custom picture and metadata settings, those settings will be recorded with the clip. For more details, refer to *Custom Picture Settings* (☞ 96) and *Using Metadata* (☞ 79).

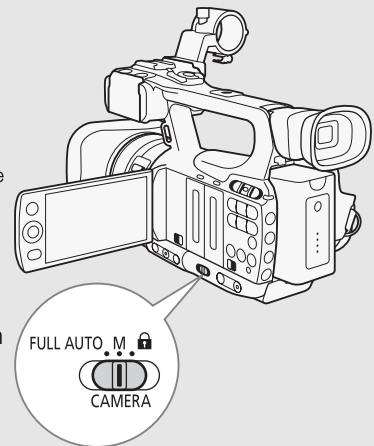

## Onscreen Displays

Refer to this section for an explanation of the various screen displays that appear in **CAMERA** mode. You can use the custom display function (☞ 105) to display or hide most of the screen displays. Such screen displays are denoted with an asterisk (\*).

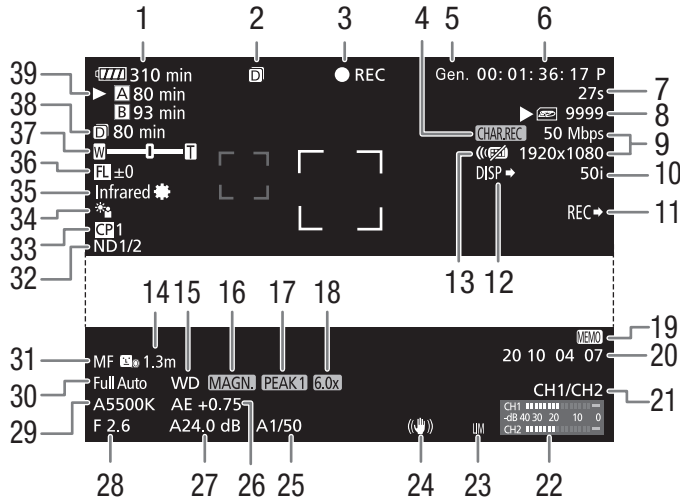

When displaying the date and time:

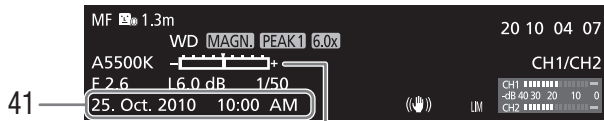



40

- |  |  |
|--|--|
| 1 Remaining battery time* (☞ 43)               | 23 Audio peak limiter (☞ 78)                       |
| 2 Double slot recording (☞ 38)                 | 24 Image stabilizer* (☞ 52)/OIS lens shift (☞ 92)  |
| 3 Recording operation* (☞ 43)                  | 25 Shutter speed* (☞ 55)                           |
| 4 Character recording* (☞ 104)                 | 26 AE level* (☞ 58)                                |
| 5 Genlock (☞ 72)                               | 27 Gain* (☞ 53)                                    |
| 6 Time code* (☞ 69)                            | 28 Aperture value* (☞ 57)                          |
| 7 Interval counter* (☞ 85)                     | 29 White balance* (☞ 59)                           |
| 8 SD card status*                              | 30 Full auto mode* (☞ 41)/                         |
| 9 Bit rate/Resolution* (☞ 45)                  | Lock* (☞ 41)                                       |
| 10 Frame rate* (☞ 45)                          | 31 Focus mode* (☞ 47)                              |
| 11 <b>XF105</b> SDI recording command* (☞ 147) | 32 ND filter* (☞ 144)                              |
| 12 Output displays* (☞ 144)                    | 33 Custom picture* (☞ 96)                          |
| 13 Wireless controller* (☞ 144)                | 34 Light metering mode* (☞ 58)                     |
| 14 Object distance* (☞ 144)                    | 35 Infrared mode, infrared light (☞ 90)            |
| 15 Conversion lens*                            | 36 Focal length guide (☞ 93)                       |
| 16 Magnification* (☞ 49)                       | 37 Zoom indicator* (☞ 62)                          |
| 17 Peaking* (☞ 48)                             | 38 Remaining recording time for double slot        |
| 18 Digital tele-converter* (☞ 140)             | recording (☞ 38)                                   |
| 19 User memo* (☞ 79)                           | 39 CF card status/available recording time* (☞ 43) |
| 20 User bit* (☞ 71)                            | 40 Exposure bar* (☞ 54)                            |
| 21 Audio output channel* (☞ 126)               | 41 Date/time* (☞ 25)                               |
| 22 Audio level meter (☞ 78)                    |  |

## NOTES

- You can press the DISP. button to turn off most icons and displays.
- When the **A** icon appears next to the white balance, aperture value, gain or shutter speed, it indicates that the setting is in auto mode.

### 1 Remaining battery time

- The icon shows a rough estimate of the remaining charge as a percentage of the full charge of the battery pack. The remaining recording/playback time of the battery pack is displayed, in minutes, next to the icon.
-  (in red).  
When  is displayed, replace the battery pack with a fully charged one.
- Depending on the conditions under which the camcorder and the battery pack are used, the actual battery charge may not be indicated accurately.



### 3 Recording operation

● REC	Recording
STBY	Record pause
● INT REC	Interval recording
INT STBY (INT flashes)	Interval record pause
● FRM REC	Frame recording
● FRM STBY	Frame record pause (after starting recording)
FRM STBY (FRM flashes)	Frame record pause (before starting recording)
● S&F REC	Slow & fast motion recording
S&F STBY	Slow & fast motion record pause
● PRE REC	Pre-recording (after pressing the START/STOP button)
PRE REC STBY	Pre-recording (before pressing the START/STOP button)

### 14 Conversion lens

- When the optional WD-H58W Wide-converter is attached to the camcorder, the **WD** icon will appear.  
When the optional TL-H58 Tele-converter is attached, the **TL** icon will appear.

### 38 CF card status/available recording time

- The following indicates the CF card status.
  - A** / **B** Can record on CF card
  -  /  No CF card or cannot record on CF card
- The CF card selected for recording is indicated with a **▶** mark.

## Power Save Mode

Activate the power save mode to turn off the screen and reduce battery consumption. At the press of a button, the camcorder will immediately return to record pause mode.

- 1 Hold the **POWER SAVE** button pressed down for at least 2 seconds.
  - The screen will turn off and the **ON/OFF** indicator will illuminate in orange.
  - During power save mode, the tally lamps will flash twice approximately every 3 seconds. The camcorder retains previous time code and camcorder settings.
- 2 Press the **POWER SAVE** button to return the camcorder to record pause mode.

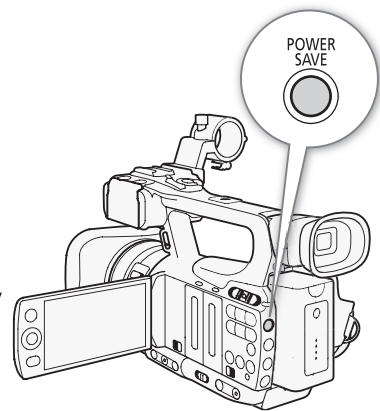



## Video Configuration: Bit Rate, Resolution and Frame Rate

Before you record, select the bit rate, resolution (frame size) and frame rate that best match your creative needs.

Operating modes: **CAMERA** **MEDIA**

1 Open the [Bit Rate/Resolution] submenu to set the bit rate and resolution.

[Other Functions] → [Bit Rate/Resolution]

2 Select the desired option and then press SET.

- The selected bit rate and resolution will appear on the right side of the screen.
- If you selected [35 Mbps 1440x1080], [Frame Rate] will automatically be set to [50i] so you do not need to continue with the rest of this procedure.

3 Open the [Frame Rate] submenu to set the frame rate.

[Other Functions] → [Frame Rate]

4 Select the desired option and then press SET.

- The selected frame rate will appear on the right side of the screen.

### NOTES

- For details on the signal output from each terminal, refer to *Video Output Configuration* (121).

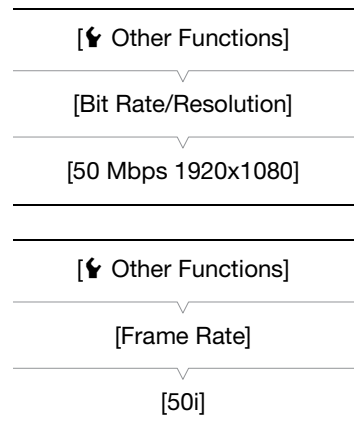

### Available bit rate, resolution and frame rate settings

Bit rate*	Resolution	Frame rate		
		50i	50P	25P
50 Mbps (CBR 4:2:2)	1920 x 1080	●	–	●
	1280 x 720	–	●	●
35 Mbps (VBR 4:2:0)	1920 x 1080	●	–	●
	1440 x 1080	●	–	–
	1280 x 720	–	●	●
25 Mbps (CBR 4:2:0)	1440 x 1080	●	–	●

\* The first line indicates the bit rate (in Mbps); the second line indicates in parentheses whether the bit rate is constant (CBR) or variable (VBR), and the color sampling.

## Custom Button and Dial

You can assign to the CUSTOM button and dial one of several frequently used functions. You can then adjust the selected function using the CUSTOM button and dial, without having to access the menu. The functions that can be assigned to the CUSTOM button differ depending on whether the camcorder is in Infrared mode.

Operating modes: CAMERA MEDIA

### 1 Open the [Custom Key/Dial] submenu.

[ Other Functions] [Custom Key/Dial]

### 2 Select [Normal] or [Infrared] and then press SET.

- [Normal] refers to when the camcorder is not in Infrared mode.

### 3 Select the desired option and then press SET.

- If you selected [Normal], [IR Light] will not be an available option. If you selected [Infrared], [Iris(ND)] and [Face AF] will not be available options.

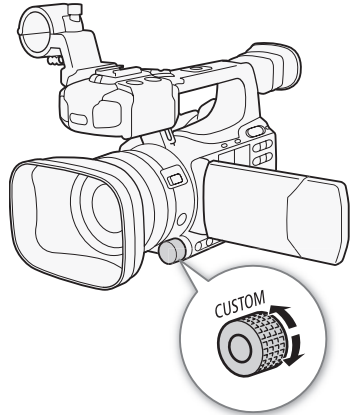

### Options

- [Iris(ND)]: Aperture adjustment ( 57). Press the CUSTOM button to toggle between manual and automatic aperture adjustment and turn the dial to adjust the aperture.
- [Face AF]: Face autofocus ( 50). Press the CUSTOM button to toggle between the [Face AF] settings ([Face Pri.], [Face Only], [Off]) and turn the dial to change the main subject.
- [IR Light]: Infrared light ( 90). If [ Camera Setup] [Infrared] [Light] is set to [Toggle], press the CUSTOM button to turn the infrared light on/off.
- [Headphone Volume]: Headphone volume ( 111). Turn the CUSTOM dial to adjust the headphone volume.
- [Tele-converter]: Digital tele-converter ( 140). Press the CUSTOM button to turn the digital tele-converter on/off and turn the dial to select 1.5x, 3x or 6x.
- [Off]: Use this setting if you do not intend to use the CUSTOM button or dial.

### NOTES

- To open the option menu, you can hold down the CUSTOM button for at least 2 seconds instead of the procedure above.

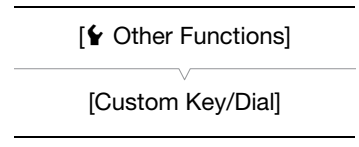

## Adjusting the Focus

This camcorder features the following two methods for adjusting the focus.

**Manual focus (MF):** Use the manual ring to adjust the focus. You can use the peaking and magnification functions to help you focus more accurately.

**Autofocus (AF):** The camcorder continuously adjusts the focus automatically. When using autofocus, you can select Instant AF, Medium AF or Normal AF mode. You can also use the manual ring.

Operating modes: CAMERA MEDIA

### Manual Focus Mode

Turn the manual ring to manually adjust the focus. The faster you turn the manual ring, the more quickly you can focus on your subject.

#### 1 Move the manual ring switch to FOCUS.

- If [MF] appears on the bottom left of the screen, the camcorder is in manual focus mode. Skip to step 3. If [LAF] appears instead, the camcorder is in autofocus mode. Proceed to step 2.

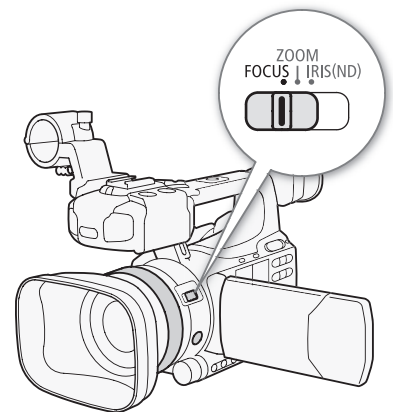

#### 2 Press the AF/MF button.

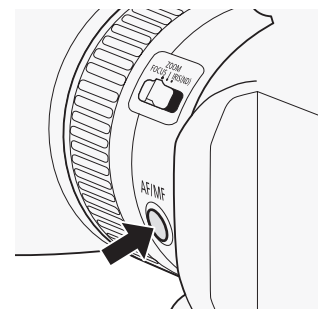

#### 3 Turn the manual ring to adjust the focus.

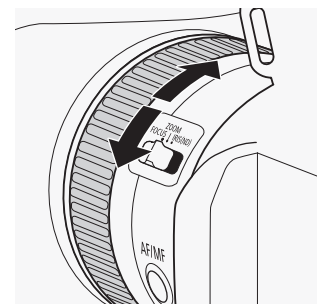

**i** NOTES• **Using the subject distance display on the screen:**

- When the camcorder switches out of autofocus mode or when you adjust the focus with the manual ring, the approximate subject distance is displayed on the screen for approximately 3 seconds.
  - Use the subject distance display as an estimate; when the distance reading is not considered very precise for a particular zoom range, it will be displayed in gray.
  - [ $\infty$ ] indicates infinity focus and [ $\infty$ -] indicates over infinity focus.
  - You can change the units of distance between meters and feet using the [**f** Other Functions]  $\odot$  [Custom Function]  $\odot$  [Obj. Dist. Unit] setting (📖 104).
  - The correct subject distance will not be displayed when the optional WD-H58W Wide-converter or TL-H58 Tele-converter is attached.
- You can use the manual ring to adjust the focus while you are operating the zoom. When the camcorder is initially in autofocus mode, it will return to autofocus mode after you manually adjust the focus.
  - You can set the response sensitivity of the manual ring using the [**f** Other Functions]  $\odot$  [Custom Function]  $\odot$  [F. Ring Control] setting (📖 104).
  - If you focus manually and then leave the camcorder with the power turned on, the focus on the subject may be lost after a while. This possible slight shift in focus is a result of the internal temperature rising in the camcorder and lens. Check the focus before resuming shooting.

**Using the Focus Assistance Functions**

In order to focus more accurately, you can use two focus assistance functions – peaking, which creates a clearer contrast by emphasizing the outlines of the subject, and magnifying, which enlarges the image on the screen. You can use both functions simultaneously for greater effect.

You can also use the [**f** Other Functions]  $\odot$  [Custom Function]  $\odot$  [F. Assist. B&W] setting (📖 104) to switch the screen to black & white while using the focus assistance functions.

**Peaking**

The camcorder offers two peaking levels. Select the level before activating peaking.

1 Open the [Select] submenu (under [Peaking]) to select the peaking level.

[**L** LCD/VF Setup]  $\odot$  [Select] (under [Peaking])

2 Select the desired level and then press SET.

3 Open the [Peaking] submenu.

[**L** LCD/VF Setup]  $\odot$  [Peaking]

4 Select [On] and then press SET.

- The peaking icon (**PEAK1**) or (**PEAK2**) appears and the outlines in the image will be emphasized.

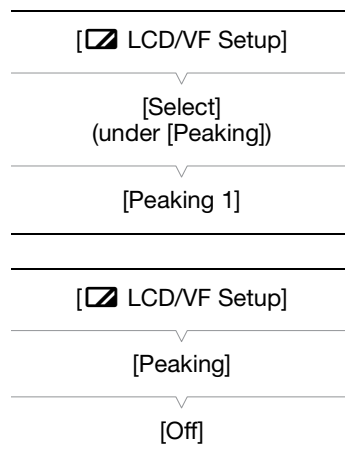
**i** NOTES

- Peaking appears only on the camcorder screen. It will not appear on an external monitor connected to the camcorder.
- Peaking will not affect your recordings.
- You can set the color, gain and frequency of the two peaking levels independently of each other.
- When you are adjusting the focus, you can use the [**f** Other Functions]  $\odot$  [WFM (LCD)]  $\odot$  [Edge Monitor] setting (📖 82) to help you focus even more accurately.
- If you set an assignable button to [Peaking] (📖 94), you can press the button to activate the selected peaking level.

## Magnification

Press the **MAGN.** button.

- **MAGN.** appears on the bottom of the screen and the center of the screen is magnified approximately 2 times\*.
- Press the button again to cancel the function.

\* The magnification that appears on the LCD screen and on the viewfinder screen is different. The magnification also differs based on the video configuration.

### **i** NOTES

- Magnification appears only on the camcorder screen. It will not appear on an external monitor connected to the camcorder.
- Magnification will not affect your recordings.

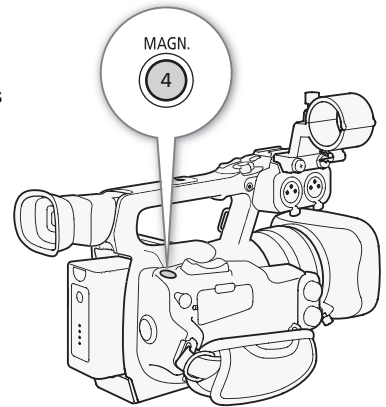

## Autofocus Mode

The camcorder uses the TTL autofocus system and continuously adjusts the focus on the subject in the center of the screen. The focusing range is 2 cm (at full wide-angle, measured from the front of the lens barrel) to  $\infty$ .

During autofocus mode, you can turn the manual ring to focus manually. When you stop turning the ring, the camcorder returns to autofocus mode. This is useful in situations such as when focusing on a subject on the other side of a window.

Press the **AF/MF** button.

- **AF** appears on the bottom left of the screen.

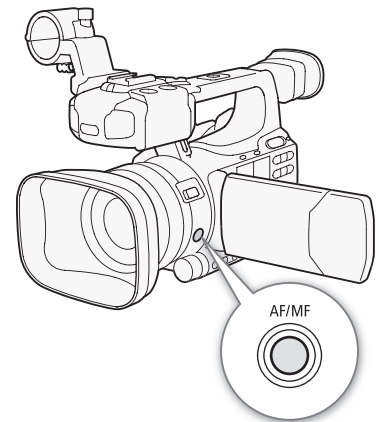

## Setting the Autofocus Mode

You can select how the camcorder focuses during autofocus mode.

- 1 Open the autofocus [Speed] submenu.  
[Camera Setup]  $\odot$  [AF Mode]  $\odot$  [Speed]
- 2 Select the desired option and then press SET.

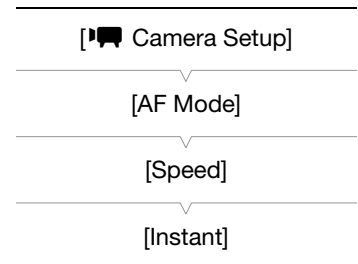

**Options**

- [Instant]: Sets the autofocus mode to Instant AF. The focus is adjusted at the highest speed. This mode is useful even when recording in very bright or low-light surroundings. This mode uses both the TTL system and external sensor for focusing.
- [Medium]: Sets the autofocus mode to Medium AF. The camcorder focuses more smoothly on the subject than when using the [Instant] setting.
- [Normal]: Sets the autofocus mode to Normal AF. The autofocus adjustment is made at a stable speed.

**i** NOTES

- When recording in bright surroundings, the camcorder closes down the aperture. This may cause the picture to appear blurred and is more noticeable toward the wide-angle end of the zoom range. In such case, set the [Camera Setup] [ND Filter] setting (139) to [Automatic].
- When you attach the optional WD-H58W Wide-converter or TL-H58 Tele-converter to the camcorder, the [Instant] and [Medium] settings are not available.
- Autofocus takes longer to focus when the frame rate is set to [25P] than when it is set to [50i].
- When recording under dark conditions, the focusing range narrows and the picture may appear blurred.
- Autofocus may not work well on the following subjects or in the following cases. In such case, focus manually.
  - Reflective surfaces
  - Subjects with low contrast or without vertical lines
  - Fast moving subjects
  - Through dirty or wet windows
  - Night scenes

**Detecting and Focusing On Faces**

The camcorder can detect a person's face during autofocus mode, automatically focus on it, and even track it if the person moves. When there are a number of people in the picture, one person (with the white face detection frame) will be determined to be the main subject and the camcorder will focus on that person's face.

**1 Open the [Face AF] submenu.**



[Camera Setup] [AF Mode] [Face AF]

**2 Select the desired option and then press SET.****3 Set an assignable button to [Select Face] (94).****4 Point the camcorder at the subject.**

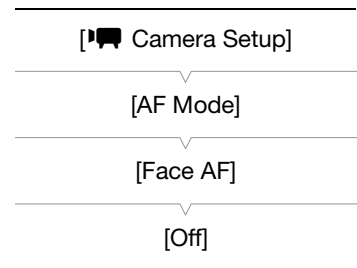



- If there is more than one person in the picture, the camcorder will automatically select one person it determines is the main subject. The camcorder will indicate the main subject with a white face detection frame and other faces with gray frames.
- To change the main subject when there is more than one person, press the assignable button set to [Select Face] (94) or set [Other Functions] [Custom Key/Dial] [Normal] to [Face AF] (46) and turn the CUSTOM dial.



### Options

- [Face Pri.] : This sets the camcorder to face priority autofocus. If the camcorder detects the subject's face, the camcorder focuses on and tracks it. When there is no face detected, the camcorder focuses on the subject at the center of the screen.
- [Face Only] : If the camcorder detects the subject's face, the camcorder focuses on and tracks it. Unlike the [Face Pri.] setting, when there is no face detected, the camcorder is set to manual focus.
- [Off]: Use this setting if you do not intend to use [Face AF].

### NOTES

- The camcorder may mistakenly detect the faces of non-human subjects. In such case, turn face detection off.
- In certain cases, faces may not be detected correctly. Typical examples include:
  - Faces extremely small, large, dark or bright in relation to the overall picture.
  - Faces that are turned to the side, at a diagonal or partially hidden.
- Face detection cannot be used in the following cases:
  - When the shutter speed used is slower than 1/25.
  - When using slow & fast motion recording mode and the shooting frame rate is set to less than 24P.
  - When [Other Functions]  [Custom Function]  [Scan Reverse Rec] is set to an option other than [Off].
  - When Infrared mode is on.
- When a subject's face is detected, the camcorder adds an event mark to that frame. You can then use the Canon XF Utility software to search for event marks in a clip.
- If you set an assignable button to [Face AF] ( 94) or set the CUSTOM button and dial to [Face AF] ( 46), you can press the button to toggle between [Face Pri.], [Face Only] and [Off].

## Focus Limit and Macro Shooting

By default, the camcorder's focus range allows macro shooting. You can activate the focus limit to restrict the focus range. The focus range 2 cm (at full wide-angle) to  $\infty$  is limited to 60 cm to  $\infty$  (throughout the entire zoom range).

### 1 Open the [Focus Limit] submenu.

 Camera Setup  [Focus Limit]

### 2 Select [On] and then press SET.

- Select [Off] to enable macro shooting.

### NOTES

- If you set an assignable button to [Focus Limit] ( 94), you can press the button to activate the focus limit.

---

 Camera Setup

---

[Focus Limit]

---

[Off]

---

## Image Stabilizer

Use the image stabilizer to compensate for camcorder shake in order to achieve steadier shots. There are 3 methods of image stabilization; select the method that best suits your needs.

**Dynamic IS** (👉): Dynamic IS compensates for a higher degree of camcorder shake, such as when shooting while walking, and is more effective as the zoom approaches full wide angle.

**Standard IS** (👉): Standard IS compensates for a lower degree of camcorder shake, such as when shooting while remaining stationary, and is suitable for shooting natural-looking scenes.

**Powered IS** (👉): Powered IS is most effective when you are stationary and zooming in on far subjects using high zoom ratios (the more you approach the telephoto end). This mode is not suitable for tilting and panning shots.

Dynamic IS and Standard IS are activated using the camera menu. Powered IS is activated using an assignable button.

### To activate Dynamic IS or Standard IS

Operating modes: CAMERA MEDIA

#### 1 Open the [OIS Functions] submenu.

[Camera Setup] ➤ [OIS Functions]

#### 2 Select [Img Stab.] and then press SET.

- Select [Off] to turn off image stabilization.

#### 3 Open the [Image Stabilizer] submenu.

[Camera Setup] ➤ [Image Stabilizer]

#### 4 Select [Dynamic] or [Standard] and then press SET.

- The icon of the selected mode appears on the bottom of the screen.

### To activate Powered IS

By default, assignable button 1 is set to [Powered IS]. Press the button to activate Powered IS. The Powered IS icon (👉) appears on the bottom of the screen.

### NOTES

- If you set an assignable button to [Img Stab.] (📖 94), you can press the button to turn the selected image stabilization method on or off.
- If the degree of camcorder shake is too high, the image stabilizer may not be able to fully compensate.
- When you are using [Dynamic] mode, the edges of the picture may be adversely affected (such as ghosting, artifacts and dark areas) when compensating for a high degree of camcorder shake.
- When the camcorder is mounted on a tripod, turn off image stabilization.
- You can activate Powered IS even when image stabilization is turned off.

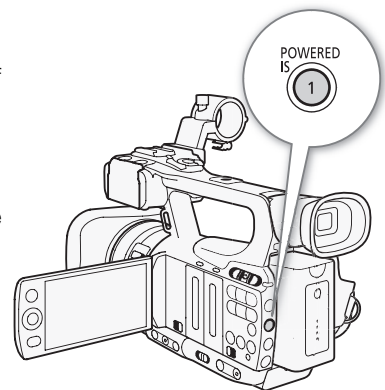

[Camera Setup]

[OIS Functions]

[Img Stab.]



## Gain

The gain control adjusts the level of the video signal generated depending on the lighting and shooting conditions. You can select automatic or manual gain control.

Operating modes: CAMERA MEDIA

### Automatic Gain Control (AGC)

The camcorder automatically adjusts the gain based on the subject's brightness. If manual gain control is activated, follow the procedure below to activate automatic gain control.

Press the GAIN button repeatedly until the **A** icon appears next to the gain value on the screen.

- When you set the camcorder to full auto mode (📖 41), automatic gain control will be activated.

### Setting the Gain Limit (AGC Limit)

When the AGC switch is set to ON, you can activate the gain limit to prevent the camcorder from setting a level higher than a preset limit between 3 dB and 21 dB.

- 1 Open the [AGC Limit] submenu.  
[🗨 Camera Setup] ● [AGC Limit]
- 2 Select the desired level and then press SET.

#### Available Gain Limits

Off/24 dB	21 dB	18 dB	15 dB	12 dB	9 dB	6 dB	3 dB
-----------	-------	-------	-------	-------	------	------	------

#### **i** NOTES

- When you set the camcorder to full auto mode (📖 41), [AGC Limit] will be set to [Off/24 dB].

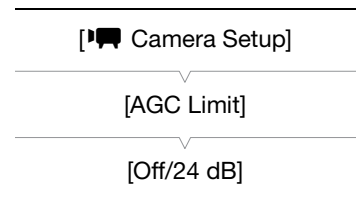
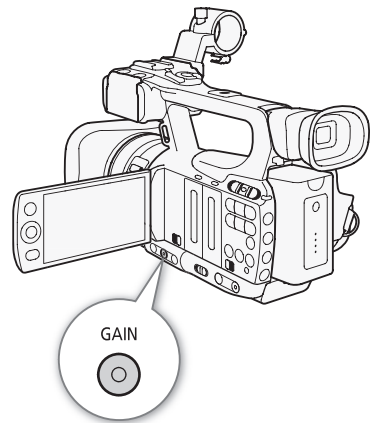

## Manual Gain Control

You can manually adjust the gain of the 3 preset gain levels (L: low, M: middle, H: high). Each level can be set independently. You can also fine-tune the gain in 0.5 dB increments.

### Assigning Gain Values

You can assign separate gain values to the L, M and H preset levels. Then, you can activate the desired gain level using the GAIN button.

1 Open the [Gain] submenu.

[Camera Setup]  $\rightarrow$  [Gain]

2 Select [L], [M] or [H] and then press SET.

3 Select the desired gain level.

- To fine-tune the gain, select [Fine Tuning] and then select the desired gain level.
- Repeat steps 2 and 3 to set other preset levels, as necessary.

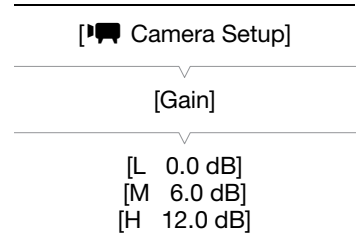

### Available Gain Levels

Setting	Description
-6.0 dB, -3.0 dB	For the lowest noise recording when recording indoor, low-light or low-contrast scenes.
0.0 dB	For lifelike night scenes or scenes under artificial lighting.
3.0 dB, 6.0 dB, 12.0 dB, 18.0 dB, 24.0 dB, 33.0 dB	Increases the brightness in indoor or low-light scenes that are especially dark.
[Fine Tuning] (0.0 to 24.0 dB)	Select [Fine Tuning] to adjust the gain in 0.5 dB increments.

### Applying the Assigned Gain Level

Press the GAIN button.

- Each time you press the button, the gain will change in the following sequence: AGC  $\rightarrow$  L  $\rightarrow$  M  $\rightarrow$  H. The camcorder's gain level will change accordingly.

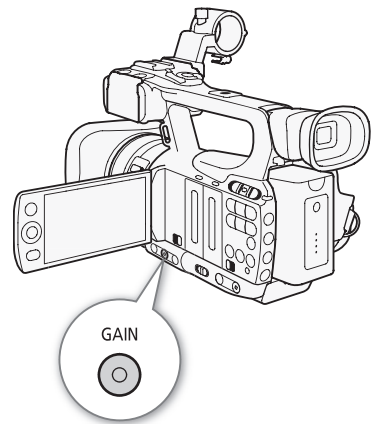

#### Exposure Bar



Exposure bar

When the gain and aperture are set to manual and the shutter speed is not set to auto, the exposure bar will appear on the screen. The exposure bar indicates the approximate exposure adjustment within a range of  $\pm 2$  EV. Beyond this range, the indicator will flash.

### NOTES

- When you select high gain levels, the picture may flicker slightly. The 33.0 dB gain level in particular, allows you to shoot video with a higher sensitivity but is more prone to the appearance of noise and artifacts (white dots, vertical streaks or blocking).
- You can use the [Other Functions]  $\rightarrow$  [Custom Function]  $\rightarrow$  [Shockless Gain] setting (104) for a smooth transition when changing the gain.

## Shutter Speed

Set the shutter speed based on the recording conditions. For example, you may want to set slower shutter speeds in darker environments. The camcorder offers the following 6 modes.

Operating modes:

**Off:** The camcorder uses a standard shutter speed based on the frame rate.

**Automatic ([Automatic]):** The camcorder automatically adjusts the shutter speed based on the picture's brightness. This mode is not available during slow & fast motion recording mode. In this mode, the **A** icon will appear on the screen next to the shutter speed.

**Speed ([Speed]):** Allows you to set the shutter speed (in fractions of a second).

**Angle ([Angle]):** You can set the shutter angle to determine the shutter speed.

**Clear scan ([Clear Scan]):** Set the frequency in order to record CRT computer monitors without displaying black bands or flicker on the screen.

**Slow shutter ([Slow]):** You can set slower shutter speeds to obtain brighter recordings in places with insufficient lighting. This mode is not available during slow & fast motion recording mode.

### Available Shutter Speeds

The available shutter speeds vary depending on the frame rate.

Shutter speed mode	Frame rate	
	50i	25P
Off <sup>1</sup>	1/50	1/25
Auto <sup>2</sup>	1/50 to 1/500	1/25 to 1/500
Speed	1/50, 1/60, 1/75, 1/90, 1/100, 1/120, 1/150, 1/180, 1/210, 1/250, 1/300, 1/350, 1/400, 1/500, 1/600, 1/700, 1/800, 1/1000, 1/1200, 1/1400, 1/1600, 1/2000	1/25, 1/29, 1/30, 1/33, 1/40, 1/50, 1/60, 1/75, 1/90, 1/100, 1/120, 1/150, 1/180, 1/210, 1/250, 1/300, 1/350, 1/400, 1/500, 1/600, 1/700, 1/800, 1/1000, 1/1200, 1/1400, 1/1600, 1/2000
Angle	360°, 300°, 240°, 180°, 150°, 120°, 90°, 60°, 45°, 30°, 22.5°, 15°, 11.25°	360°, 300°, 240°, 180°, 150°, 120°, 90°, 75°, 60°, 45°, 30°, 22.5°, 15°, 11.25°
Clear scan	50 Hz to 249.46 Hz	25 Hz to 249.46 Hz
Slow shutter <sup>2</sup>	1/3, 1/6, 1/12, 1/25	1/3, 1/6, 1/12
Infrared mode	1/50 to 1/120	1/25 to 1/120
Slow shutter during Infrared mode <sup>2</sup>	1/25 to 1/120	1/12 to 1/120

<sup>1</sup> During slow & fast motion recording mode, the shutter speed will be based on the selected shooting frame rate.

<sup>2</sup> Not available during slow & fast motion recording mode.

## Changing the Shutter Speed Mode

1 Open the [Shutter] submenu.

[Camera Setup] ➤ [Shutter]

2 Select the desired mode and then press SET.

3 Close the menu and then press the SHUTTER button.

- If you selected [Automatic], the shutter speed mode is set to automatic and you do not need to perform the rest of the procedure.
- The shutter speed on the screen appears highlighted in orange.

4 Use the joystick to adjust the shutter speed.

- For [Clear Scan], adjust the frequency so that black bands do not appear.

5 Press SET.



- The orange frame will disappear. The selected setting and shutter speed mode will be set.
- To set the shutter speed mode to off, press the SHUTTER button again.

### Using Slow Shutter Mode

When recording in dark surroundings, you can obtain a brighter picture by using slow shutter mode. You can also use this mode when you wish to add certain effects to your recordings, such as blurring the background during panning shots or recording a moving subject with an afterimage trail.

- Image quality may not be as good as when using faster shutter speeds in brighter surroundings.
- Autofocus may not work well.

### NOTES

- When you record under bright conditions using automatic aperture control, the camcorder closes down the aperture. This may cause the picture to appear blurred. To prevent this, set the shutter speed to 1/100 or faster.
- When you set the camcorder to full auto mode ( 41), the shutter speed mode will be set to auto (except in slow & fast motion recording mode).
- When the gain and aperture are set to manual and the shutter speed is not set to auto, the exposure bar will appear on the screen ( 54).

## Flicker Reduction

You can reduce flicker caused by recording under fluorescent lamps.

1 Open the [Flicker Reduction] submenu.

[Camera Setup] ➤ [Flicker Reduction]

2 Select [Automatic] and then press SET.

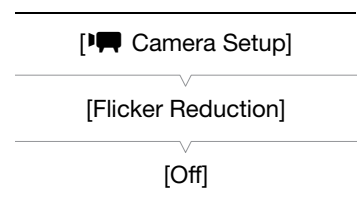
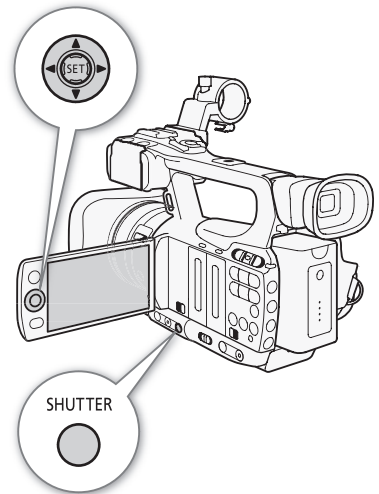
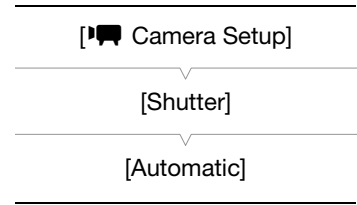

## Adjusting the Aperture

You can affect the brightness of your recordings or change the depth of field by adjusting the aperture. Increase the aperture value (F8) so that objects that are close and far away will be in focus. You can have the camcorder adjust the aperture automatically or you can manually adjust it to give you more control over your recording.

Operating modes: CAMERA MEDIA

### Automatic Aperture Control

The camcorder automatically adjusts the aperture based on the brightness of the subject. If manual aperture control is activated, follow the procedure below to activate automatic aperture control.

Press the IRIS button.

- The A icon appears next to the aperture value on the screen.
- When you set the camcorder to full auto mode (📖 41), the camcorder automatically controls the aperture.

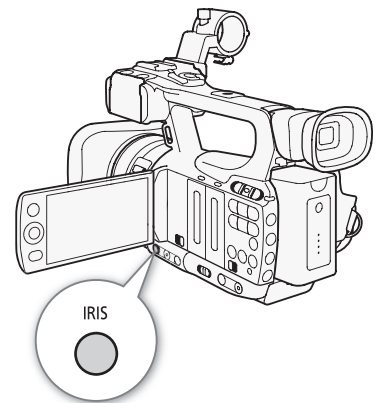

### Manual Aperture Control

When automatic aperture control is not activated, follow the procedure below to adjust the aperture manually.

- 1 Move the manual ring switch to IRIS(ND).
  - Alternatively, you can use the CUSTOM dial to manually adjust the aperture (📖 46).
- 2 Turn the manual ring to adjust the aperture.
  - The f-number displayed on the screen will be in 1/4-stop increments.

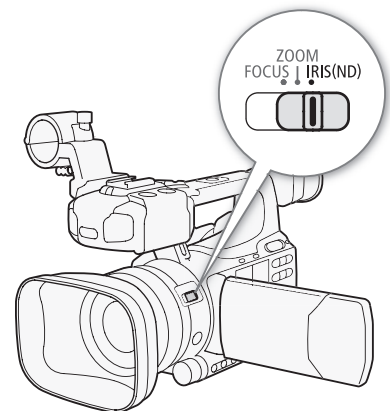

#### Available aperture settings

F1.8	F2.0	F2.2	F2.4	F2.6	F2.8	F3.2	F3.4	F3.7	F4.0	F4.4
F4.8	F5.2	F5.6	F6.2	F6.7	F7.3	F8.0	F8.7*	F9.5*	F10*	F11*
F12*	F14*	F15*	F16*	F17*	F19*	F21*	F22*	CLOSE*		

\* Can be selected only when the [👤 Other Functions] ⌚ [Custom Function] ⌚ [Iris Limit] setting is set to [Off].

#### NOTES

- If you set [🗨 Camera Setup] ⌚ [ND Filter] to [Automatic], the ND filter will activate automatically depending on the recording conditions.
- When the gain and aperture are set to manual and the shutter speed is not set to auto, the exposure bar will appear on the screen (📖 54).
- You can use the [👤 Other Functions] ⌚ [Custom Function] ⌚ [Iris Limit] setting (📖 104) to prevent the aperture from closing below the diffraction limit of the lens (F8.0). When it is on, the maximum aperture value is [F8.0]. When it is off, you can fully close the aperture but aperture values that exceed the diffraction limit will appear in gray. Using aperture values displayed in gray will cause diffraction blur.

- When you set the aperture value manually, it is not retained if you activate automatic aperture control (excluding full auto mode). The aperture value set automatically by the camcorder will be retained when you switch back to manual aperture control.
- If the built-in ND filter is activated, the picture may become dark when you set a high aperture value. In such case, set the ND filter to [Off] and readjust the aperture.
- You can use the [Other Functions] [Custom Function] [I. Ring Direction] setting (104) to change the direction of the adjustment when you turn the manual ring.
- You can set the [Other Functions] [Custom Function] [ZR-2000 AE SHIFT] setting (104) to [Iris] to change the aperture value using the AE SHIFT dial on the optional ZR-2000 Zoom Remote Controller.

## Adjusting the AE Level

Use the AE shift control to adjust AE level in order to darken or lighten the image. You can select from 15 AE levels.

1 Open the [AE Shift] submenu.

[Camera Setup] [AE Shift]

2 Select an AE level and then press SET.

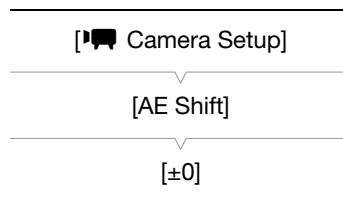

### Available AE Levels

+2.0	+1.5	+1.25	+1.0	+0.75	+0.5	+0.25	±0
-0.25	-0.5	-0.75	-1.0	-1.25	-1.5	-2.0	

### NOTES

- You cannot adjust the AE level if the camcorder is set to full auto mode (41).
- You can set the [Other Functions] [Custom Function] [ZR-2000 AE SHIFT] setting (104) to [AE Shift] to adjust the AE level using the AE SHIFT dial on the optional ZR-2000 Zoom Remote Controller.

## Setting the Light Metering Mode

Select the light metering mode to match the recording conditions. This will ensure that your subject will have a more suitable exposure level.

1 Open the [Light Metering] submenu.

[Camera Setup] [Light Metering]

2 Select the desired option and then press SET.

- The icon of the selected mode appears on the left side of the screen.

### Options

[Backlight] : Suitable when recording backlit scenes.

[Standard]: Averages the light metered from the entire screen, giving more weight to the subject in the center.

[Spotlight] : Use this option when recording a scene in which only a certain part of the picture is lit.

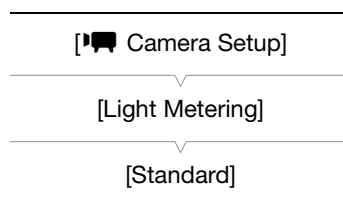

### NOTES

- When you set the camcorder to full auto mode (41), [Light Metering] will be set to [Standard].
- If you set an assignable button to [Backlight] or [Spotlight] (94), you can press the button to change the light metering mode.

## White Balance

The camcorder uses an electronic white balance process to calibrate the picture for accurate color display under different lighting conditions. There are 4 methods of setting the white balance.

**Auto white balance:** The camcorder automatically adjusts the white balance to the optimal level.

**Preset white balance:** Set the white balance to either [Daylight] or [Tungsten].



**Set color temperature:** Allows you to set the color temperature between 2,000 K and 15,000 K.

**Custom white balance:** You can use a white object to measure the white balance and set it to one of two preset positions.

When recording under fluorescent lights, we recommend using auto white balance or setting the custom white balance.

Operating modes: CAMERA MEDIA

### NOTES

- The settings in the [Custom Picture]  [Color Matrix] and [White Balance] settings ( 96) take precedence over the white balance settings.

## Auto White Balance

The camcorder constantly adjusts the white balance automatically to achieve an optimal level. The camcorder will adjust the white balance if the light source changes.

### Press the WB button.

- The A icon appears next to the color temperature on the screen. If another icon appears or no icons appear, press the button again until the A icon appears.
- When you set the camcorder to full auto mode ( 41), auto white balance mode will be activated.

### NOTES

- Custom white balance may provide better results in the following cases:
  - Changing lighting conditions
  - Close-ups
  - Subjects in a single color (sky, sea or forest)
  - Under mercury lamps and certain types of fluorescent lights

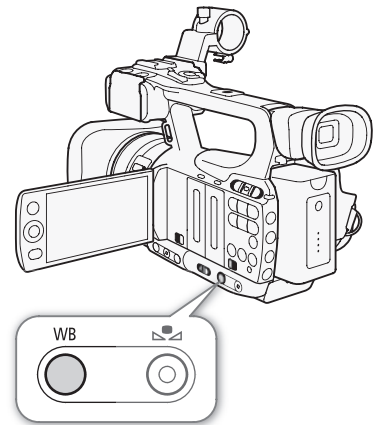

## Preset White Balance

The camcorder comes preset with outdoor (daylight) and indoor (incandescent light) settings. You can fine tune the setting after selecting it.

1 Open the [White Balance] submenu.

 Camera Setup  [White Balance]

2 Select the desired option and then press SET.

 Camera Setup

[White Balance]

[Daylight]

3 Close the menu and then press the WB button.

- Press the button repeatedly until the icon of the desired setting appears in the lower left of the screen.

Options

[Daylight] ☀: Suitable for recording scenes such as sunrises/sunsets, fireworks or night scenes.

[Tungsten] 🔥: Suitable for recording scenes such as at a party with changing lighting conditions or scenes under studio lighting or sodium lamps.

[Kelvin]: Allows you to set the color temperature value (📖 60).

Fine-tuning the Preset White Balance

You can fine-tune the [Daylight] and [Tungsten] settings within a range of -9 to 9.

1 Press the  button.

- The white balance icon on the screen is highlighted in orange.

2 Select the desired adjustment level with the joystick.

3 Press the  button.

- The white balance icon will no longer be highlighted in orange. The adjustment level will appear next to the icon.

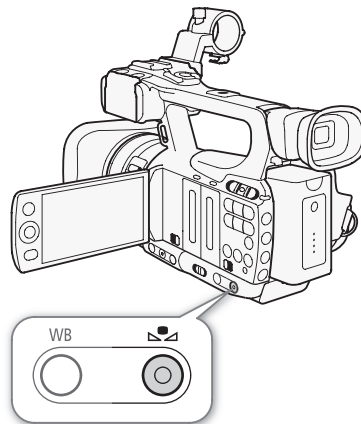

Setting the Color Temperature

The following procedure allows you to specify the color temperature between 2,000 K and 15,000 K in 100 K increments.

1 Open the [White Balance] submenu.

 Camera Setup  [White Balance]

2 Select [Kelvin] and then press SET.

3 Close the menu and then press the  button.

- If auto white balance is activated, press the WB button and then press the  button.
- The displayed color temperature appears highlighted in orange.

4 Select the desired color temperature with the joystick and then press the  button.

- The color temperature will be set and the displayed color temperature will no longer be highlighted in orange.

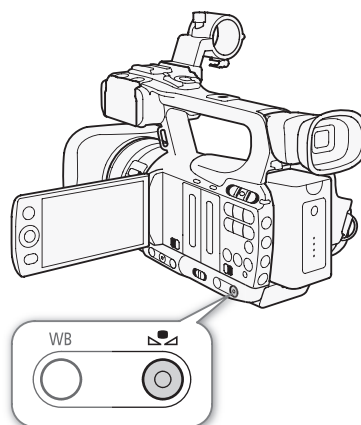
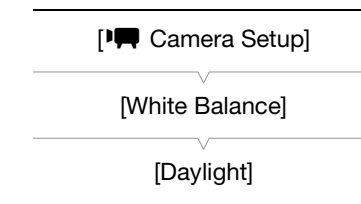





## Custom White Balance

You can store two custom white balance settings in the camcorder for future use.



### 1 Press the WB button to select the A or B custom setting.

- The  A or  B appears next to the color temperature on the screen. If another icon appears or no icon appears, press the button again until the desired icon appears.

### 2 Point the camcorder at a white object so that it fills the whole screen.



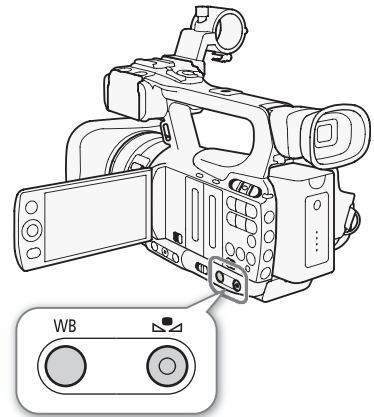

- Use the same lighting conditions you plan to use when recording.

### 3 Press the button.

- The  A or  B icon will flash quickly.
- Make sure the white object fills the screen until the procedure is completed.
- After the icon stops flashing, the procedure is completed. The setting is retained even if you turn off the camcorder.



### NOTES

- Set the [ Camera Setup]  [Tele-converter] setting ( 140) to [Off] in advance.
- Readjust the custom white balance if the light source changes.
- Very rarely and depending on the light source,  may keep flashing (it will change to a slow flashing). The result will still be better than with the auto white balance.

## Zooming

You can operate the zoom (up to 10x) using the zoom rocker on the side grip or the one on the handle. You can also use the manual ring or the zoom buttons on the wireless controller. For zooms with a gradual start and/or stop, use soft zoom control (📖 65).

You can also use the [🗨️ Camera Setup] ⏸ [Tele-converter] setting to increase the focal length by a factor of approximately 1.5, 3 or 6.\* Alternatively, you can set an assignable button to [Tele-converter] (📖 94) or set [👉 Other Functions] ⏸ [Custom Key/Dial] to [Tele-converter] (📖 46) to activate the digital tele-converter.

\* The image is digitally processed, so the image resolution may deteriorate.

Operating modes: CAMERA MEDIA

### Using the Manual Ring

Move the manual ring switch to ZOOM and then turn the manual ring.

- When you operate the zoom, a zoom indicator\* will appear on the screen that shows the approximate zoom position.

\* You can use the [👉 Other Functions] ⏸ [Custom Function] ⏸ [Zoom Indicator] setting (📖 104) to set the zoom indicator to a numerical display.

#### **i** NOTES

- If you turn the manual ring too quickly, the camcorder may not be able to zoom immediately. In such case, the camcorder will zoom after you finish turning the manual ring.

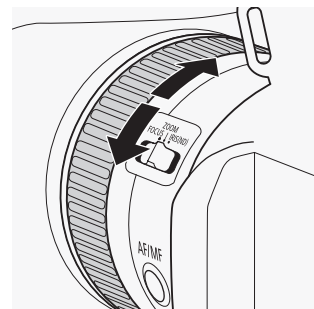
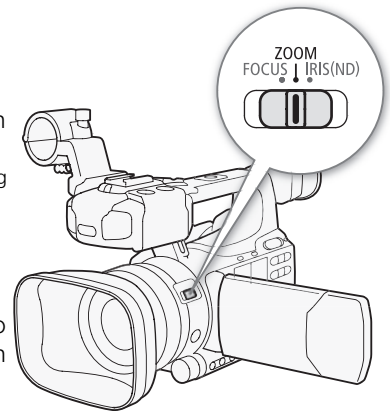

### Using the Zoom Rockers, Wireless Controller or Optional Remote Control

When you operate the zoom, a zoom indicator\* will appear on the screen that shows the approximate zoom position.

\* You can use the [👉 Other Functions] ⏸ [Custom Function] ⏸ [Zoom Indicator] setting (📖 104) to set the zoom indicator to a numerical display.

### Using the Grip Zoom Rocker

Use the functions in the [Camera Setup] [Zoom] submenus to set the zoom speed. When you select a constant zoom speed, set one of 16 constant speeds (1 is the slowest, 16 the fastest). With a variable zoom speed, press gently for a slow zoom; press harder for faster zooms.

Move the zoom rocker toward **W** to zoom out (wide-angle) and toward **T** to zoom in (telephoto).



### Setting the Zoom Speed

Refer to the following table for approximate zoom speeds of the entire zoom range (end to end).

- 1 Open the zoom [Speed Level] submenu.  
[Camera Setup] [Zoom] [Speed Level]
- 2 Select [Fast], [Normal] or [Slow] and then press SET.
- 3 Open the [Grip Rocker] submenu.  
[Camera Setup] [Zoom] [Grip Rocker]
- 4 Select [Constant] or [Variable] and then press SET.

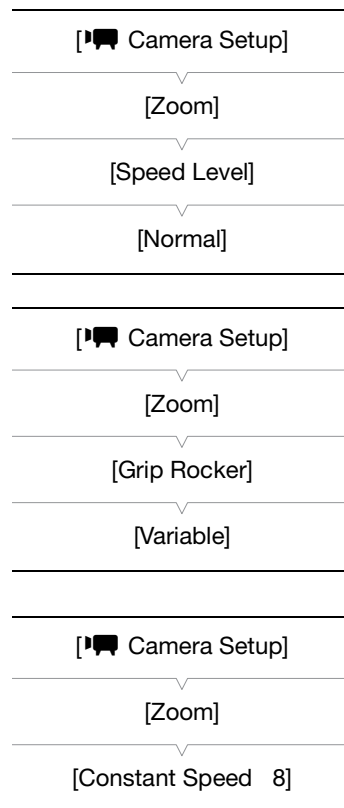

### To set the speed level for [Constant]

- 5 Open the grip rocker [Constant Speed] submenu.  
[Camera Setup] [Zoom] [Constant Speed]
- 6 Select the desired level and then press SET.

### Approximate zoom speeds (grip zoom rocker)

[Grip Rocker] setting	[Constant Speed] setting	[Speed Level] setting		
		[Slow]	[Normal]	[Fast]
[Constant]	[1] (slowest)	4 min. 45 sec.	3 min.	1 min.
	[16] (fastest)	4 sec.	3 sec.	2 sec.*
[Variable]	–	4 sec. to 4 min. 45 sec.	3 sec. to 3 min.	2 sec.* to 1 min.

\* When the zoom speed is too fast (approximately 2 seconds end-to-end), the camcorder will have more trouble focusing automatically while zooming.

### Using the Handle Zoom Rocker

Use the functions in the [Camera Setup] ➤ [Zoom] submenus to set the zoom speed.

Move the zoom rocker toward **W** to zoom out (wide-angle) and toward **T** to zoom in (telephoto).

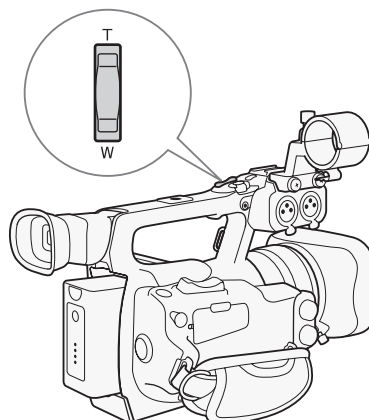

### Setting the Zoom Speed

Refer to the following table for approximate zoom speeds of the entire zoom range (end to end).

- 1 Open the zoom [Speed Level] submenu.  
[Camera Setup] ➤ [Zoom] ➤ [Speed Level]
- 2 Select [Fast], [Normal] or [Slow] and then press SET.
- 3 Open the zoom [Handle Rocker] submenu.  
[Camera Setup] ➤ [Zoom] ➤ [Handle Rocker]
- 4 Select the desired level and then press SET.
  - You can select [Off] if you do not intend to use the handle zoom rocker.

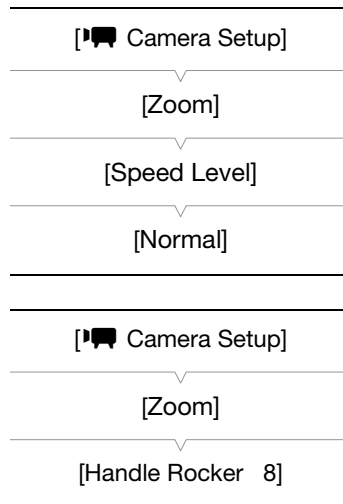

### Approximate zoom speeds (handle zoom rocker)

[Handle Rocker] setting	[Speed Level] setting		
	[Slow]	[Normal]	[Fast]
[1] (slowest)	4 min. 45 sec.	3 min.	1 min.
[16] (fastest)	4 sec.	3 sec.	2 sec.*

\* When the zoom speed is too fast (approximately 2 seconds end-to-end), the camcorder will have more trouble focusing automatically while zooming.

## Using the Wireless Controller or Optional Remote Control

The zoom speeds when using the wireless controller and when using an optional (ZR-2000 or ZR-1000 Zoom Remote Controller) or commercially available remote control connected to the REMOTE terminal are different. When using the wireless controller, you must press the record enable button and desired zoom button simultaneously to zoom.

### Setting the Zoom Speed

Perform the following procedure to set the zoom speed for the supplied wireless controller. Refer to the following table for a summary of zoom speeds when using the wireless controller or other remote controls.

- 1 Open the zoom [Speed Level] submenu.  
[Camera Setup] Ⓞ [Zoom] Ⓞ [Speed Level]
- 2 Select [Fast], [Normal] or [Slow] and then press SET.
- 3 Open the zoom [Wireless Controller] submenu.  
[Camera Setup] Ⓞ [Zoom] Ⓞ [Wireless Controller]
- 4 Select the desired level and then press SET.
  - This setting affects both the wireless controller and optional remote controls.

### Zoom speeds

Accessory	Zoom speed
Wireless controller (supplied)	Constant zoom speed that is selected from the menu.
Remote control without variable zoom speed control (commercially available)	Constant zoom speed.
Remote control with variable zoom speed control (optional ZR-2000 or ZR-1000 Zoom Remote Controller, etc.)	Based on zoom speed setting of the remote control.

## Soft Zoom Control

Soft zoom control allows you to start and/or stop the zoom gradually.

- 1 Open the [Soft Zoom Control] submenu.  
[Camera Setup] Ⓞ [Zoom] Ⓞ [Soft Zoom Control]
- 2 Select the desired option and then press SET.

### Options

- [Both]: Zoom starts and stops gradually.  
 [Stop]: Zoom stops gradually.  
 [Start]: Zoom starts gradually.  
 [Off]: Use this setting if you do not intend to use soft zoom control.

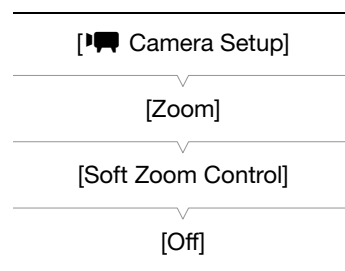
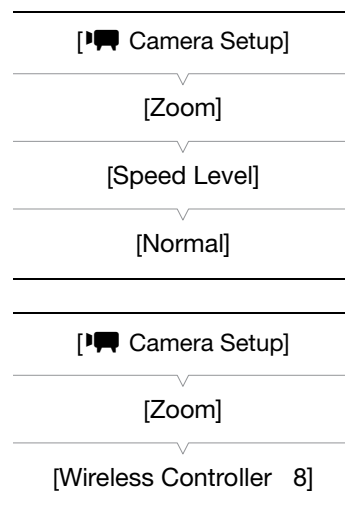

## Using Optional Conversion Lenses

Attaching the optional TL-H58 Tele-converter increases the focal length of the camcorder by a factor of approximately 1.5. Attaching the optional WD-H58W Wide-converter decreases the focal length by a factor of approximately 0.8. When you attach a conversion lens, perform the procedure below to optimize the autofocus and minimum object distance for the particular lens.

Operating modes: CAMERA MEDIA

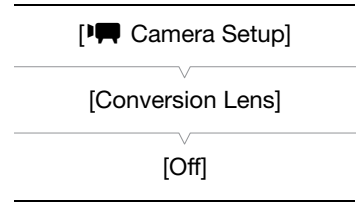

### 1 Open the [Conversion Lens] submenu.

[Camera Setup] ➤ [Conversion Lens]

### 2 Select [TL-H58] or [WD-H58W] and then press SET.

- If the autofocus is set to Instant AF or Medium AF, it will change to Normal AF.
- The minimum object distance throughout the entire zoom range will be approximately 130 cm when using the tele-converter and approximately 40 cm when using the wide-converter.
- Select [Off] if you do not intend to use a conversion lens.

### NOTES

- If you set an assignable button to [TL-H58] or [WD-H58W] ([94](#)), you can press the button to optimize the settings for the selected conversion lens.
- Vignetting may occur when taking wide angle shots with a tele-converter.
- The approximate subject distance displayed on the screen will change depending on the [Conversion Lens] setting. If you are not using a conversion lens, select [Off].

## Onscreen Markers and Zebra Patterns

Using onscreen markers allows you to make sure your subject is correctly framed and is within the appropriate safe area. The zebra patterns help you identify areas that are overexposed. The onscreen markers and zebra pattern will not affect your recordings.

Operating modes:

### Displaying Onscreen Markers

Available types of onscreen markers are a center marker ([Center]), horizontal level marker ([Horizontal]), grid ([Grid]), safe area markers ([Safety Zone]) and aspect ratio marker ([Aspect Marker]).

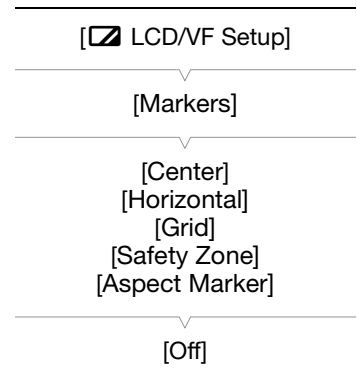
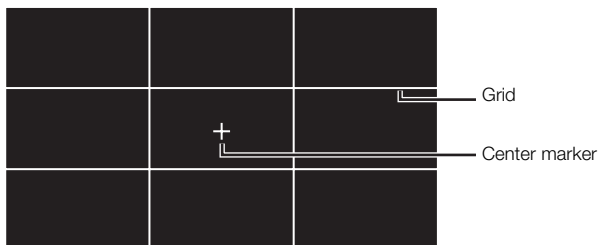
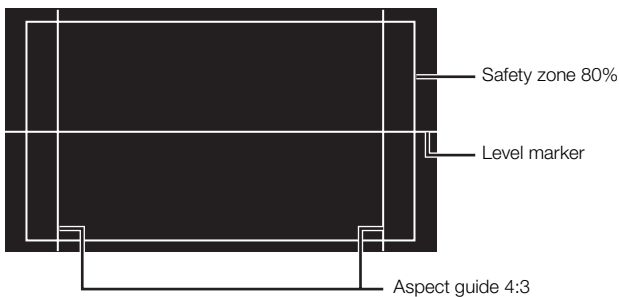

#### 1 Open the desired marker submenu.

LCD/VF Setup  [Markers]  select the desired marker (see **Options** below)

#### 2 Select [White] or [Gray] and then press SET.

- Select [Off] to turn off the selected marker.
- You can display multiple markers simultaneously. Repeat steps 1 and 2 for each marker you wish to display.
- If you selected [Safety Zone] or [Aspect Marker], continue to step 3. If not, skip to step 4.

#### 3 Select [Safety Zone Area] or [Aspect Ratio], select the desired option and then press SET.

#### 4 Select [Enable], select [On] and then press SET to enable the onscreen markers.

- All of the selected onscreen markers will be displayed.
- Select [Off] to turn off all onscreen markers.

**Options**

- [Center]: Displays a small marker that indicates the center of the screen.
- [Horizontal]: Displays a horizontal line to help you compose level shots.
- [Grid]: Displays a grid that allows you to frame your shots correctly (horizontally and vertically).
- [Safety Zone]: Displays indicators that show various safe areas, such as the action safe area and text safe area. Available options for [Safety Zone Area] are [95%], [92.5%], [90%] and [80%].
- [Aspect Marker]: Displays markers that indicate various aspect ratios to help you keep your shot within that area. Available options for [Aspect Ratio] are [2.35:1], [1.85:1], [1.75:1], [1.66:1], [14:9], [13:9] and [4:3].

**i NOTES**

- If you set an assignable button to [Markers] (📖 94), you can press the button to activate or deactivate the onscreen markers.

**Displaying Zebra Patterns**

This camcorder has a zebra pattern feature that shows black and white diagonal stripes over areas that are overexposed. This is displayed only on the screen and will not affect your recordings. There are two types of zebra patterns and you can display both simultaneously. Zebra 1 lets you identify areas within a certain range ( $\pm 5$  of a specified level) while zebra 2 lets you identify areas that are over a specified level. When you display both simultaneously and they overlap, only zebra 1 will be displayed in those areas.

- 1 Open the zebra pattern [Select] submenu.  
 LCD/VF Setup  $\rightarrow$  [Select] (under [Zebra])
- 2 Select [Zebra 1], [Zebra 2] or [Zebra 1&2] and then press SET.
- 3 Open the zebra level submenu.  
 LCD/VF Setup  $\rightarrow$  [Zebra 1 Level] or [Zebra 2 Level]
- 4 Select a zebra level and then press SET.
- 5 Open the [Zebra] submenu.  
 LCD/VF Setup  $\rightarrow$  [Zebra]
- 6 Select [On] to activate the selected zebra pattern.

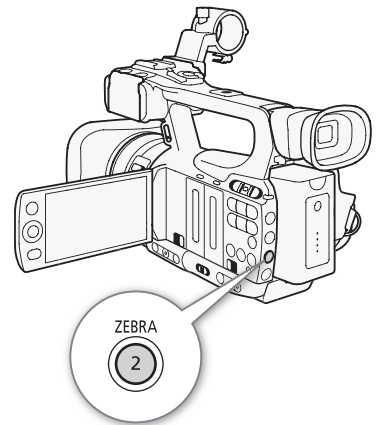
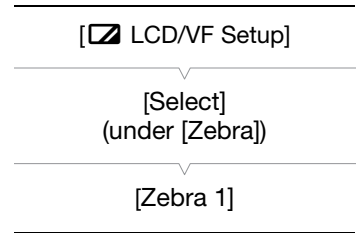



**i NOTES**

- If you set an assignable button to [Zebra] (📖 94), you can press the button to activate the selected zebra pattern.
- You can use the  LCD/VF Setup  $\rightarrow$  [HD Output] setting (📖 143) to display the zebra pattern on an external monitor connected to the HD/SD SDI terminal (**XF105** only), HDMI OUT terminal or HD/SD COMPONENT OUT terminal (HD output only).
- When the HD/SD COMPONENT OUT terminal is set to output a standard definition signal, the output will switch to a high definition signal while the zebra pattern is displayed if you set [HD Output] to [On].
- Zebra patterns will not appear in the viewfinder if you select [Zebra 1&2].



## Setting the Time Code

The camcorder can generate a time code signal and embed it in your recordings. You can have the camcorder output the time code signal from the HD/SD SDI terminal (**XF105** only) or GENLOCK/TC terminal (**XF105** only;  73). In addition, you can superimpose the time code on video output from the HDMI OUT terminal, HD/SD COMPONENT OUT terminal or AV terminal.

**XF105** To synchronize the camcorder's time code to an external time code generator, refer to *Synchronizing with an External Device* ( 72).

Operating modes: CAMERA MEDIA

### Selecting the Running Mode

You can select the running mode of the camcorder's time code.

1 Open the time code [Mode] submenu.

[00:00 TC/UB Setup]  [Time Code]  [Mode]

2 Select the desired option and then press SET.

- If you selected [Regen.], you do not need to perform the rest of this procedure. If you selected [Preset] and would like to set the time code's initial value, see the following section *Setting the Time Code's Initial Value*.

3 After you select [Preset], open the time code [Run] submenu.

[00:00 TC/UB Setup]  [Time Code]  [Run]

4 Select the desired option and then press SET.

#### Options

[Preset]: After you select this option, select a [Run] option. With [Rec Run], the time code runs only when recording and clips on the same CF card will have a continuous time code; with [Free Run], the time code runs regardless of the camcorder's operation. You can also choose to set the time code's initial value for either [Run] option.

[Regen.]: The time code runs while recording. Use this running mode to continue with the last recorded time code on the media.

### Setting the Time Code's Initial Value

If you set the running mode to [Preset], you can set the initial value of the time code.

1 Open the time code [Setting] submenu.

[00:00 TC/UB Setup]  [Time Code]  [Setting]

2 Select [Set] and then press SET.

- The time code setting screen appears with an orange selection frame indicating the hours.
- To reset the time code to [00:00:00.00], select [Reset] instead.

3 Select the hours and then move  to minutes.

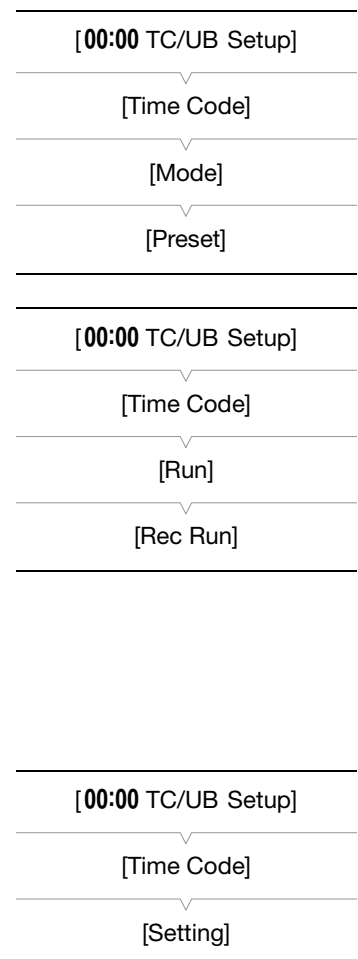

4 Change the rest of the fields (minutes, seconds, frame) in the same way.

- Press the CANCEL button to close the screen without setting the time code.

5 Select [Set] to close the screen.

- If the running mode is set to [Free Run], the time code will start running from the value set in steps 2 to 4.

## Putting the Time Code Display on Hold

If you set an assignable button to [Time Code Hold] (📖 94), you can freeze the display of the time code\*. While the time code display is put on hold, [H] will appear on the screen next to the time code.

The time code continues to run normally while the time code display is on hold. When you resume the time code display, the current time code will be displayed.

\* The time code signal output from the HD/SD SDI terminal (**XF105** only) or GENLOCK/TC terminal (**XF105** only) will not be put on hold. The time code superimposed on the video signal output from the other terminals will be put on hold.

### About the Time Code Display

An icon may appear next to the time code depending on the operation. Refer to the following table.

Icon	Description
R	The running mode is set to [Regen.].
P	The running mode is set to [Preset] with the [Rec Run] option selected.
F	The running mode is set to [Preset] with the [Free Run] option selected.
E	Time code signal is coming from an external source.
H	Time code display is on hold.
No icon	Time code during clip playback.

### NOTES

- The frames value in the time code runs from 0 to 24.
- When you are using interval recording, frame recording or slow & fast motion recording mode, you cannot select the [Free Run] option for the [Preset] running mode. Conversely, when you are using pre-recording mode, [Free Run] is automatically set and cannot be changed.
- As long as the built-in rechargeable lithium battery is charged and you selected the [Free Run] option, the time code continues to run even if you disconnect all other power sources. However, this is less accurate than when the camcorder is on.
- If you set an assignable button to [Time Code] (📖 94), you can press the button to open the [00:00 TC/UB Setup] ➤ [Time Code] submenu.

## Setting the User Bit

The user bit display can be selected from the date or the time of recording, or an identification code consisting of 8 characters in the hexadecimal system. There are sixteen possible characters: the numbers 0 to 9 and the letters A to F.

**XF105** If user bit information is being received along with an external time code, you can also record the external user bit on the recording media.

Operating modes: CAMERA MEDIA

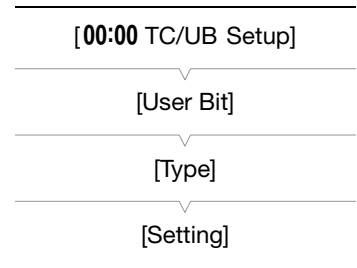

### 1 Open the user bit [Setting] submenu.

[00:00 TC/UB Setup] ➤ [User Bit] ➤ [Type] ➤ [Setting]

- To set the time for the user bit select [Time] instead; to set the date for the user bit, select [Date]. In such case, the rest of the procedure is not necessary.

### 2 Select [Set] and then press SET.

- The user bit setting screen appears with an orange selection frame on the leftmost digit.
- To reset the user bit to [00 00 00 00], select [Reset] instead.

### 3 Select an alphanumeric character (hexadecimal) then move (▶) to the next digit.

### 4 Change the rest of the digits in the same way.

- Press the CANCEL button to close the screen without setting the user bit.

### 5 Select [Set] to close the screen.

## **XF105** Synchronizing with an External Device

Using genlock synchronization, you can synchronize this camcorder's video signal to that of an external video device. Similarly, using an external time code signal, you can synchronize this camcorder's time code to the external signal. Using the external time code signal with multiple cameras allows you to set up a multi-camera recording. You can also output the time code signal from this camcorder to achieve the same result. If you output the time code from the HD/SD SDI terminal to an editing device, the editor can create video with the same time code.

### Connecting an External Device

When synchronizing the camcorder to an external signal, input a reference video signal\* or a time code signal through the GENLOCK/TC terminal. The GENLOCK/TC terminal acts as both a Genlock and time code terminal. When using a time code signal, set the terminal to input or output in advance (see below).

\* For the reference video signal, you can use an analog blackburst or tri-level signal.

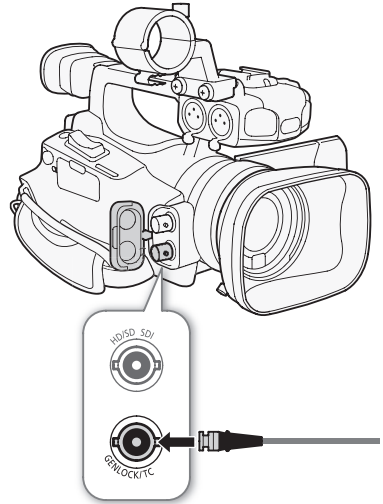

### Using a Reference Video Signal (Genlock Synchronization)

When a reference sync signal (analog blackburst or tri-level signal) is input through the GENLOCK/TC terminal, the phases of the camcorder's V and H sync will automatically be synchronized to it. The phase difference between the external Genlock signal and the camcorder is initially set to 0. The H phase can be adjusted within the range of approximately  $\pm 0.4$  H (HD equivalent).

Operating modes:

- 1 Open the [Genlock/TC Term.] submenu.
- 2 Select [Gen/TC In] and then press SET.
- 3 Open the [Genlock Adjust.] submenu.
- 4 Adjust the phase to the desired level and then press SET.
  - You can adjust the phase within -1023 to 1023. When selecting more than 999 or less than -999, set the first field to 10 or -10, respectively.

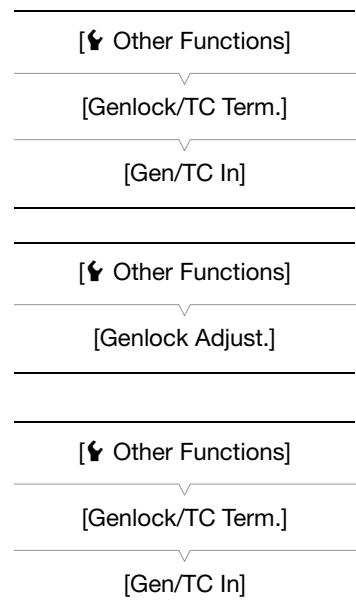

### Using a Time Code Signal

An external SMPTE-standard LTC timing signal received from the GENLOCK/TC terminal will be recorded as the time code. The user bit of the external timing signal can also be recorded. Before connecting the device, set the GENLOCK/TC terminal to input. Also, you must set the running mode of the time code to [Free Run] (69).

Operating modes:

- 1 Open the [Genlock/TC Term.] submenu.  
   [👉 Other Functions] ➤ [Genlock/TC Term.]
- 2 Select [Gen/TC In] and then press SET.

### Recording the User Bit of an External Signal

The user bit of an external time code signal can also be recorded with the time code itself.

- 1 Open the user bit [Rec Mode] submenu.  
   [00:00 TC/UB Setup] ➤ [User Bit] ➤ [Rec Mode]
- 2 Select [External] and then press SET.

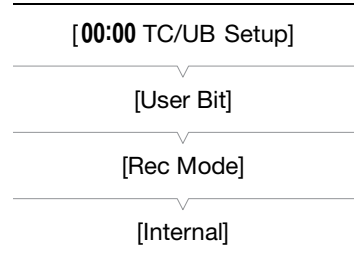

### **i** NOTES

- The Genlock signal synchronization stabilizes after approximately 10 seconds.
- Genlock synchronization is possible even when a standard definition Genlock signal is input. However, Genlock synchronization is not possible when the camcorder's video configuration is 1080i and the input signal is 720P.
- If the external Genlock signal is incorrect or there is no input signal, the external time code that is recorded may be incorrect.
- When an external time code signal is received, the camcorder's own time code will be synchronized to it and the synchronization will be maintained even if you disconnect the cable from the GENLOCK/TC terminal. However, performing any of the following actions while the cable is not connected will cause the synchronization to be disrupted; the correct time code will be restored once you reconnect the cable.
  - Turning the camcorder off/on
  - Changing the operating mode to **MEDIA** mode
  - Changing the video configuration
  - Changing the frame rate
- If the external time code signal is incorrect or there is no input signal, the internal time code set in the [00:00 TC/UB Setup] ➤ [Time Code] submenu will be recorded instead.

### Time Code Signal Output

The time code will be output from the GENLOCK/TC terminal as an SMPTE-standard LTC timing signal. The user bit will also be output. Before connecting the device, set the GENLOCK/TC terminal to output. If you set the [📺 Video Setup] ➤ [SDI Output] setting to [HD] or [SD], the embedded time code will be output from the HD/SD SDI terminal.

Operating modes: **CAMERA** **MEDIA**

- 1 Open the [Genlock/TC Term.] submenu.  
   [👉 Other Functions] ➤ [Genlock/TC Term.]
- 2 Select [TC Out] and then press SET.

### **i** NOTES

- The user bit of the time code signal is output while the camcorder is recording in **CAMERA** mode or during playback of a clip in **MEDIA** mode.

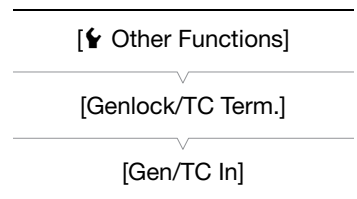

## Recording Audio

The camcorder features two-channel linear PCM audio recording and playback with a sampling frequency of 48 kHz. You can record audio using the built-in microphone, optional external microphone (XLR or MIC terminal) or line input (XLR terminal). You can select the audio input independently for channel 1 and channel 2.

When using external microphone, use commercially available microphone with a cable no longer than 3 m.

Operating modes: CAMERA MEDIA

### Using the Built-in or External Microphone Connected to the MIC Terminal

Follow the step below when you use the built-in microphone or an external microphone with a  $\varnothing$  3.5 mm plug attached to the MIC terminal. You can use the microphone attenuator for either type of microphone. If you are using the built-in microphone, you can also use the low-cut filter and select the sensitivity.

Set the AUDIO IN switch of the desired channel to INT.

- If you connect a microphone to the MIC terminal while the AUDIO IN switch is set to INT, the camcorder will switch automatically from the built-in microphone to the external microphone.

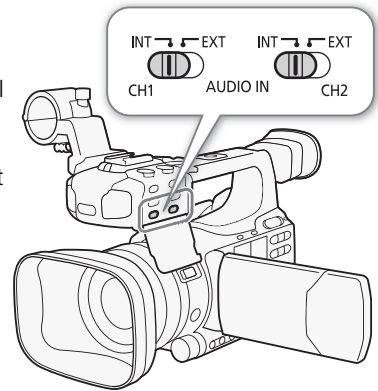

### Configuring the Built-in Microphone's Low-Cut Filter

- 1 Open the [Int. Mic Low Cut] submenu.  
[M] Audio Setup → [Audio Input] → [Int. Mic Low Cut]
- 2 Select the desired option and then press SET.

#### Options

- [Off]: For recording audio under usual conditions.  
 [LC1]: For recording mainly people's voices.  
 [LC2]: For reducing the background sound of wind when recording outdoors in windy surroundings (for example, on a beach or close to buildings). Note that when you use this setting some low-frequency sounds may be suppressed along with the sound of wind.

### Selecting the Built-in Microphone's Sensitivity

- 1 Open the [Int. Mic Sensitivity] submenu.  
[M] Audio Setup → [Audio Input] → [Int. Mic Sensitivity]
- 2 Select the desired option and then press SET.

#### Options

- [Normal]: For recording audio under usual conditions.  
 [High]: For recording audio at a higher volume (+6 dB).

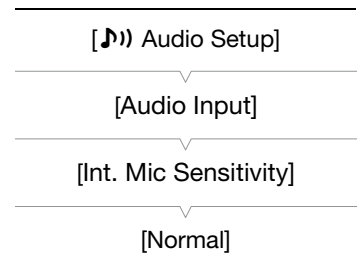
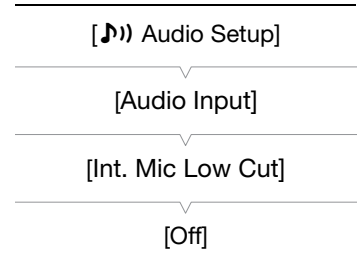

## Activating the Microphone Attenuator

If the audio level is too high and the sound sounds distorted when recording with the built-in microphone or a microphone connected to the MIC terminal, activate the microphone attenuator (12 dB for the built-in microphone, 20 dB for an external microphone).

- 1 Open the [Int. Mic Att.] submenu.  
[M] Audio Setup ➤ [Audio Input] ➤ [Int. Mic Att.]
- 2 Select [On] and then press SET.

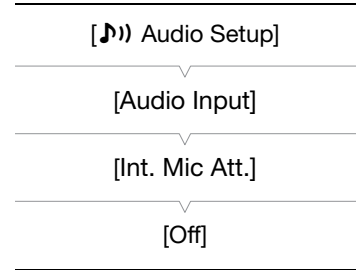

## Using Line Input or an External Microphone Connected to an XLR Terminal

### Connecting an External Microphone to an XLR Terminal

Follow the procedure below to attach an external microphone to an XLR terminal (refer also to the following illustration).

- 1 Loosen the microphone lock screw (①), open the microphone holder unit and insert the microphone (②).
- 2 Tighten the lock screw and put the microphone cable through the microphone cable clamp under the microphone holder unit (③).
- 3 Plug the microphone cable into the desired XLR terminal (④).

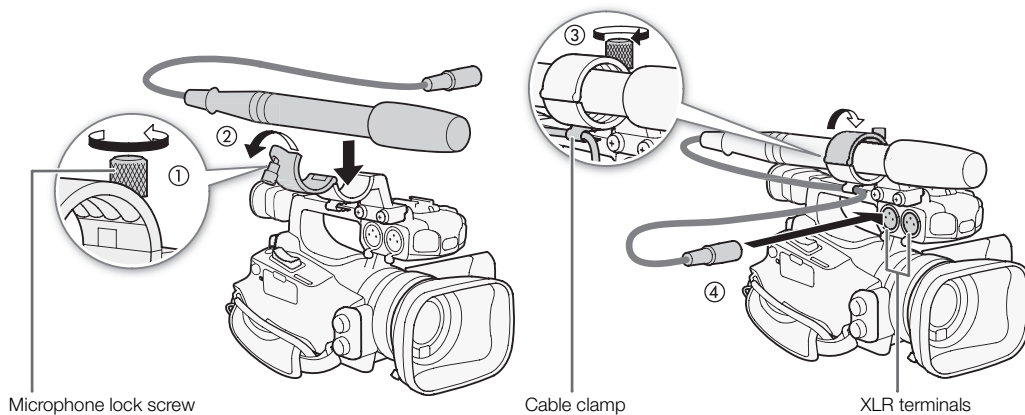

### Switching Between External Microphone and Line Input

- 1 Set the AUDIO IN switch of the desired channel to EXT.
- 2 Set the XLR terminal switch of the desired channel to LINE or MIC.
  - To supply a microphone with phantom power, set the switch to MIC+48V instead. Make sure to connect the microphone first, before turning the phantom power on. Keep the microphone connected when turning off the phantom power.
  - When using the XLR terminal to record to only one channel, use the CH1 input terminal and set the XLR terminal switch for CH1 to LINE, MIC or MIC+48V.

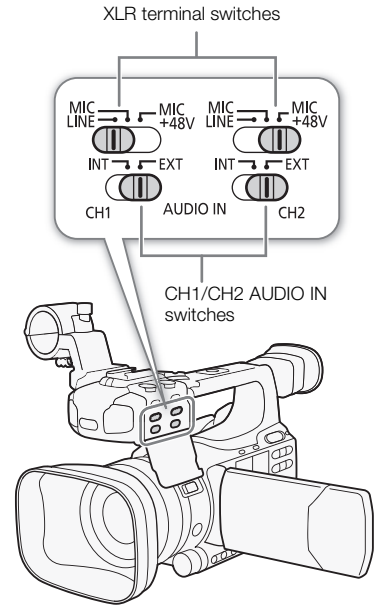

### Selecting the Recording Channel

You can select to which channel the camcorder will record audio.

- 1 Open the [XLR Rec Channel] submenu.
  - [J) Audio Setup] ➤ [Audio Input] ➤ [XLR Rec Channel]
- 2 Select the desired option and then press SET.

#### Options

- [CH1]: Records audio to each channel separately. Audio input into CH1 is recorded to channel 1, while audio input into CH2 is recorded to channel 2.
- [CH1/CH2]: Audio input into CH1 is recorded to both channels. Audio input into CH2 will not be recorded.

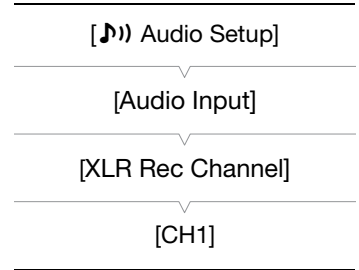

### Adjusting the External Microphone's Sensitivity

You can adjust the external microphone's sensitivity if the XLR terminal switch is set to MIC or MIC+48V.

- 1 Open the desired XLR terminal's sensitivity submenu.
  - [J) Audio Setup] ➤ [Audio Input] ➤ [XLR1 Mic Trimming] or [XLR2 Mic Trimming]
- 2 Select the desired level and then press SET.

#### Available Sensitivity Levels

+12 dB	+6 dB	0 dB	-6 dB	-12 dB
--------	-------	------	-------	--------

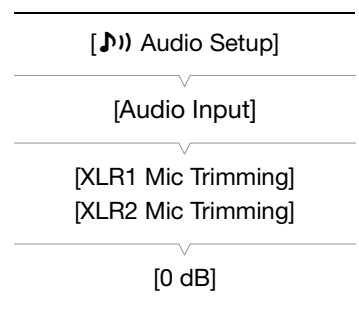



## Activating the Microphone Attenuator

You can activate the external microphone's attenuator (20 dB) if the XLR terminal switch is set to MIC or MIC+48V.

- 1 Open the desired XLR terminal's microphone attenuator submenu.  
[🎵] Audio Setup] ➤ [Audio Input] ➤ [XLR1 Mic Att.] or [XLR2 Mic Att.]
- 2 Select [On] and then press SET.

### ! IMPORTANT

- When connecting a microphone or device that does not support phantom power, make sure to set the XLR terminal switch to MIC or LINE, respectively. If you set the switch to MIC+48V, the microphone or device may be damaged.

## Adjusting the Audio Level

You can set the audio level to auto or manual for each channel. When both CH1 and CH2 are set to the built-in microphone (📖 74), the settings for CH1 will automatically be applied to CH2.

### Automatic Audio Level Adjustment

Set the audio level switch of the desired channel to A (automatic) to let the camcorder automatically adjust that channel's audio level. If CH1 and CH2 are set to the built-in microphone and you set CH1 to automatic audio level adjustment, then the camcorder will also automatically adjust the audio level for CH2.

### i NOTES

- When both CH1 and CH2 are set to the same audio input (external microphone or external line input), if the audio level is set to automatic, you can use the [🎵] Audio Setup] ➤ [Audio Input] ➤ [XLR ALC Link] setting (📖 142) to link the audio level adjustment of both channels.

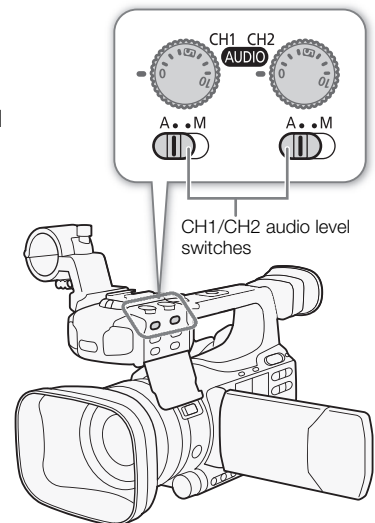
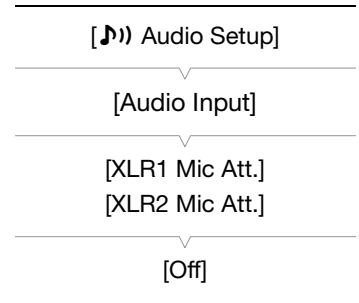

### Manual Audio Level Adjustment

You can set the audio level for each channel manually from  $-\infty$  to 18 dB.

- 1 Set the audio level switch of the desired channel to M.
- 2 Turn the corresponding audio level dial to adjust the audio level.
  - For reference, the 0 corresponds to  $-\infty$ , 5 corresponds to 0 dB, and 10 corresponds to +18 dB.
  - As a guideline, adjust the audio recording level so that the audio level meter will go to the right of the -18 dB mark (one mark right of the -20 dB mark) only occasionally.

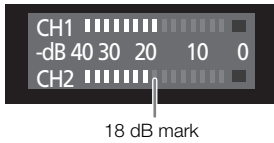

#### **i** NOTES

- You can activate the audio peak limiter to prevent audio distortions. When activated, the audio peak limiter will limit the amplitude of audio input signals when they exceed -4 dBFS. Use the [Audio Setup] > [Audio Input] > [Limiter] setting. The audio peak limiter can be activated if at least one of the channels is set to manual audio level adjustment.
- We recommend using headphones when adjusting the audio level. If the input level is too high, audio may become distorted even if the audio level indicator shows an appropriate level. Use commercially available headphones with a cable no longer than 3 m.

### Monitoring the Audio with Headphones

Connect headphones to the (headphone) terminal to monitor the recorded audio. You can use the [Audio Setup] > [Audio Output] > [Headphone Volume] setting to adjust the volume. Alternatively, you can use the CUSTOM dial (46).

#### **i** NOTES

- Use commercially available headphones with a cable no longer than 3 m.
- When you are monitoring the audio, you can choose to synchronize the audio signal with the video signal or monitor the audio in real time. Use the [Audio Setup] > [Audio Output] > [Monitor Delay] setting to select the method. Note that there will be a slight delay when you monitor in real time. Regardless of the setting, however, the audio and video signals recorded will be synchronized.

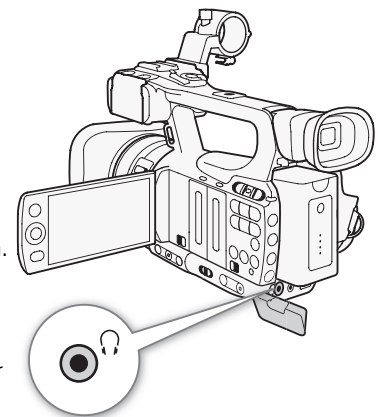
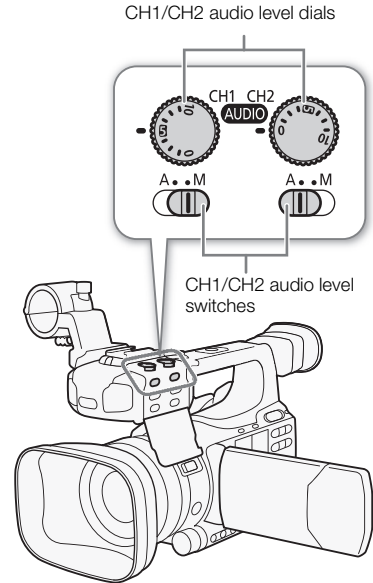

## Using Metadata

The camcorder automatically adds metadata to clips while they are being recorded. Metadata consists of the user-defined user memo\* and recording data, such as shutter speed, exposure and focus settings. You can use the **Canon XF Utility** software to check and search for specific metadata.

\* The user memo contains the clip title (up to 100 characters), camera operator (up to 100 characters), location (up to 100 characters) and clip description (up to 1,000 characters).

Operating modes: CAMERA MEDIA

### Setting a User Memo

Before you can add a user memo, you must first install the **Canon XF Utility** software (📖 128). Next, create the user memo and then save it to an SD card. Once you insert the SD card in the camcorder and select the user memo, it will be added to clips you record.

For details on using the software, refer to the instruction manual that is installed with the **Canon XF Utility** software (📖 131).

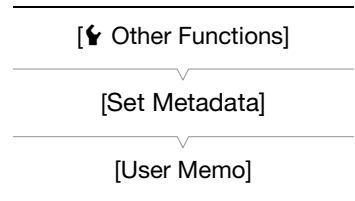

- 1 Use **Canon XF Utility** to save a user memo to an SD card.
  - For details, refer to *Managing User Memo Profiles* in the Canon XF Utility Instruction Manual.
- 2 Insert the SD card into the SD card slot of the camcorder.
- 3 Open the [User Memo] submenu.
  - [Other Functions] ⌵ [Set Metadata] ⌵ [User Memo]
- 4 Select the file name of the desired user memo and then press SET.
  - The **MEMO** icon appears on the right side of the screen.
  - Select [Off] to record clips without a user memo.

#### **i** NOTES

- You must set the user memo before you start recording for it to be added to the clip. You cannot change the user memo of a clip using the camcorder but you can do so with the **Canon XF Utility** software.
- You can also set a user-defined country code, organization code and user code for the metadata (📖 147), which is based on the UMID standard. However, the **Canon XF Utility** software cannot display or search for this information.
- After you set a user memo, do not remove the SD card while you are recording. If the SD card is removed, the user memo will not be added to the clip.

## Color Bars/Audio Reference Signal

You can have the camcorder generate and record color bars and a 1 kHz audio reference signal and output them from the HD/SD SDI terminal (**XF105** only), HDMI OUT terminal, HD/SD COMPONENT OUT terminal<sup>1</sup>, AV terminal and  (headphone) terminal<sup>2</sup>.

<sup>1</sup> Outputs color bars only.

<sup>2</sup> Outputs audio reference signal only.

Operating modes: CAMERA MEDIA

### Recording Color Bars

You can choose between EBU ([Type 1]) and SMPTE color bars ([Type 2]).

1 Open the color bars [Type] submenu.

 Camera Setup > [Color Bars] > [Type]

2 Select [Type 1] (EBU) or [Type 2] (SMPTE) and then press SET.

3 Open the [Enable] submenu to activate the color bars.

 Camera Setup > [Color Bars] > [Enable]

4 Select [On] and then press SET.

- The selected color bars appear on the screen and will be recorded when you press the START/STOP button.
- Turning the camcorder off or changing the operating mode to MEDIA mode will deactivate the color bars.
- Alternatively, you can set an assignable button to [Color Bars] ( 94) to activate the color bars.

### Recording an Audio Reference Signal

The camcorder can output a 1 kHz audio reference signal with the color bars.

1 Open the [1 kHz Tone] submenu.

 Audio Setup > [Audio Input] > [1 kHz Tone]

2 Select the desired level and then press SET.

- Available levels are -12 dB, -18 dB and -20 dB.
- Select [Off] to turn off the signal.
- The signal is output at the selected level and will be recorded when you press the START/STOP button.

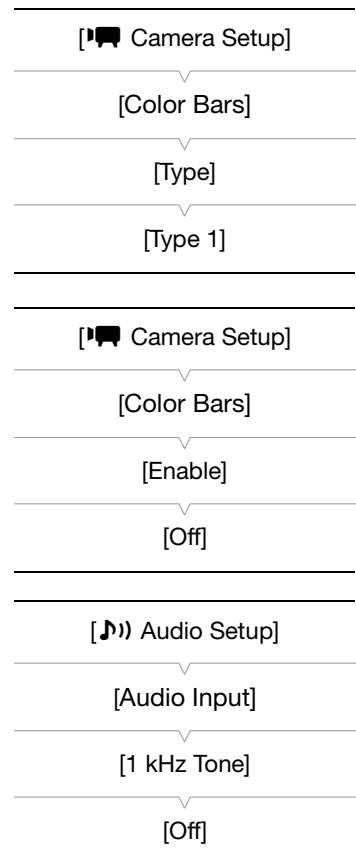

## Video Scopes

The camcorder can display a simplified waveform monitor. It can also display an edge monitor\* to help you focus. The video scopes appear only on the LCD screen. They do not appear in the viewfinder or on an external monitor.

\* The edge monitor looks at the focus of the entire picture and displays the results as a waveform. The edge monitor is available only in **CAMERA** mode.

Operating modes: **CAMERA** **MEDIA**

### Displaying a Video Scope

Press the WFM button.

- The waveform monitor will appear in a window on the lower right of the screen.
- You can repeatedly press the WFM button to activate the video scopes in the following sequence.  
Waveform monitor → Edge monitor → Off
- Alternatively, you can display the video scopes using [**Other Functions**] **[WFM (LCD)]** **[Setting]**. Select **[WFM]** for the waveform monitor or **[Edge Mon.]** for the edge monitor.

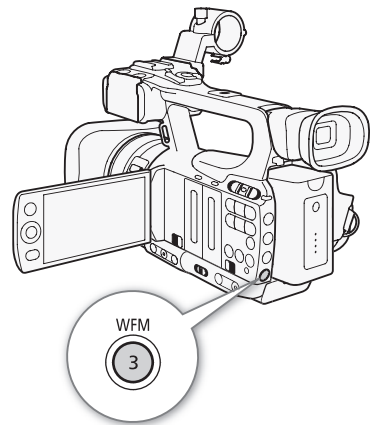

### Configuring the Waveform Monitor

The camcorder's waveform monitor function offers 5 modes. You can also change the gain.

- 1 Open the **[Waveform Monitor]** submenu.  
**[Other Functions]** **[WFM (LCD)]** **[Waveform Monitor]**
- 2 Select the desired option and then press **SET**.
  - If you do not need to change the gain, you do not need to perform steps 3 and 4.
- 3 Open the waveform monitor **[Gain]** submenu.  
**[Other Functions]** **[WFM (LCD)]** **[Gain]** (under **[Waveform Monitor]**)
- 4 Select **[1x]** or **[2x]** and then press **SET**.

#### Options

- [Line]:** Sets the waveform monitor to line display mode.
- [Line+Spot]:** The waveform of the area in the red frame is displayed in red on top of the **[Line]** mode waveform.
- [Field]:** Sets the waveform monitor to field display mode.
- [RGB]:** Functions like an RGB parade scope.
- [YPbPr]:** Functions like a YPbPr parade scope.

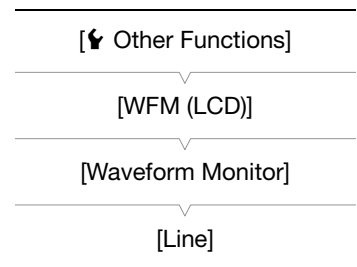

## Configuring the Edge Monitor

Using this video scope allows you to focus with more precision when the camcorder is in manual focus mode. The edge monitor features 2 modes.

1 Open the [Edge Monitor] submenu.

[ Other Functions] [WFM (LCD)] [Edge Monitor]

2 Select the desired option and then press SET.

### Options

[Type 1]: The waveform that represents the focus of the entire picture is displayed in green. In addition, the waveform of the area in the three red frames is displayed in red on top of the previous waveform.

[Type 2]: This mode displays the edge monitor with the waveform monitor in [Line+Spot] mode. The waveform monitor appears on the left in green while the edge monitor appears on the right in blue. The waveform of the area in the red frame is displayed in red on top of both green and blue waveforms.

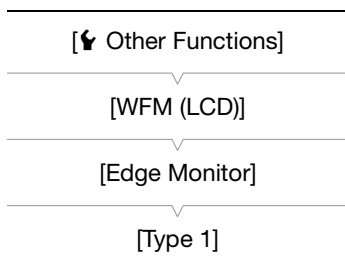

## Adding Shot Marks while Recording

When recording, you can flag an important shot in a clip by adding a “shot mark” (S). There are two types of shot marks, shot mark 1 (S1) and shot mark 2 (S2), and you can add either or both types to a single clip. When the camcorder is in MEDIA mode, you can add or delete shot marks (119). You can also display an index screen of all the shot marks (118), allowing you to find a particular scene in a clip more quickly.

Operating modes: CAMERA MEDIA

To add a shot mark to a clip while recording, you must first set in advance an assignable button to [Add Shot Mark 1] or [Add Shot Mark 2]. You can also press the SHOT1 button on the wireless controller to add the S mark.

### 1 Set an assignable button to [Add Shot Mark 1] or [Add Shot Mark 2] (94).

- To add both shot marks, set one assignable button to [Add Shot Mark 1] and another assignable button to [Add Shot Mark 2].

### 2 While you are recording, press the assignable button at the beginning of the shot you wish to mark.

- A message indicating the shot mark will appear and the selected shot mark will be added to the current frame of the clip.
- You can press the button again to add another shot mark. Up to 100 shot marks (S1 and S2 marks combined) can be added to a single clip.

### NOTES

- There may be up to a 0.5 second delay from when you press the button to when the camcorder adds the shot mark.
- When you are using interval recording or frame recording mode, you cannot add shot marks to a clip.
- When a clip contains either shot mark, S will appear next to the clip’s thumbnail in the playback index screen.

## Reviewing a Recording

When the camcorder is in **CAMERA** mode, you can review the last clip that was recorded.

Operating modes: **CAMERA** **MEDIA**

1 Open the **[Rec Review]** submenu to set the review length.

**[Other Functions]** **[Rec Review]**

2 Select the desired option and then press **SET**.

3 After you finish recording, press the **[Review]** button.

- The last clip that was recorded is played back without audio for the selected duration. **[REVIEW]** appears at the top of the screen.
- Press the **CANCEL** button to stop reviewing the clip and change the camcorder back to record pause mode.
- After the clip finishes playing back, the camcorder returns to record pause mode.

### Options

**[Entire Clip]:** Allows you to review the entire clip.

**[Last 4 sec]:** Allows you to review just the last 4 seconds of the clip.

### **i** NOTES

- When you are using a special recording mode (85), you cannot review a clip.
- If the camcorder switched CF cards during a recording, the camcorder will play back the clip on the CF card most recently recorded on.

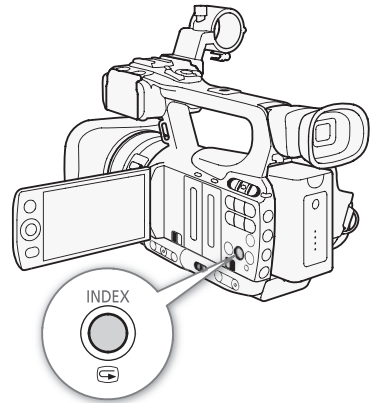
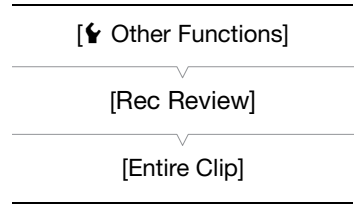



## Special Recording Modes

The camcorder features 4 special recording modes.

Interval recording ([Interval Rec]): The camcorder will automatically record a pre-defined number of frames at a pre-defined interval. This mode is suitable for recording subjects with little movement, such as natural surroundings or plants.

Frame recording ([Frame Rec]): The camcorder will record a pre-defined number of frames every time you press the START/STOP button. This mode is suitable for recording stop motion animation.

Slow & fast motion recording ([Slow & Fast Motion]): This mode allows you to change the shooting frame rate to achieve a slow motion or fast motion effect during playback.

Pre-recording ([Pre Rec]): The camcorder will start recording approximately 3 seconds before you press the START/STOP button. This is especially useful when it is difficult to predict when to start recording.

Operating modes: CAMERA MEDIA

### Interval Recording Mode

Set the interval and number of frames in advance. Sound is not recorded in this mode. This mode is not available if [👤 Other Functions] Ⓞ [Bit Rate/Resolution] is set to [35 Mbps 1440x1080].

#### Configuring Interval Recording Mode

- Open the [Interval] submenu.
  - [👤 Other Functions] Ⓞ [Interval Rec] Ⓞ [Interval]
- Select the desired interval and then press SET.
  - See the following table for the available intervals.
- Select [Rec Frames], select the desired number of frames and then press SET.
  - Available options are 2, 6 and 12.

#### Available Intervals\*

1 sec	2 sec	3 sec	4 sec	5 sec	6 sec	7 sec	8 sec	9 sec
10 sec	15 sec	20 sec	30 sec	40 sec	50 sec	1 min	2 min	3 min
4 min	5 min	6 min	7 min	8 min	9 min	10 min		

\* In the camcorder's menu, seconds are indicated by [sec] and minutes are indicated by [min].

#### Activating Interval Recording Mode and Recording

- Open the [Special Rec] submenu.
  - [👤 Other Functions] Ⓞ [Special Rec]
- Select [Interval Rec] and then press SET.
  - [INT STBY] appears at the top of the screen (with [INT] flashing).
- Press the START/STOP button to begin recording.
  - The camcorder automatically records the set number of frames at the set interval.
  - The tally lamps illuminate.
  - [INT STBY] changes to [● INT REC] while recording frames and [● INT STBY] while between intervals.

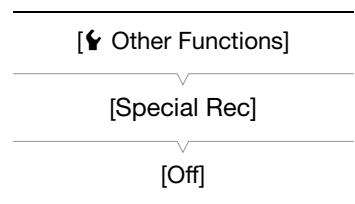
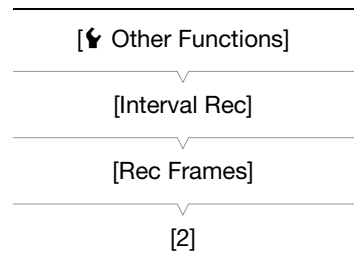
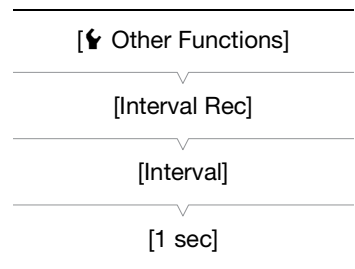

- 4 Press the START/STOP button again to stop recording.
  - All of the recorded frames are joined together into one clip.
  - The tally lamps go out and [INT STBY] appears at the top of the screen (with [INT] flashing).

**i** NOTES

- You can use only one special recording mode at a time.
- While recording, you cannot change the interval or number of frames.
- Some frames at the point the recording was stopped may be recorded and added to the end of the clip.
- Interval recording mode will be deactivated if the special recording mode is changed or turned off. It will be deactivated also if you change the [**Other Functions**] **Other Functions** [Bit Rate/Resolution] or [Frame Rate] setting.
- The time code advances by the number of frames recorded. If the running mode of the time code (**69**) is set to [Free Run] or the time code is input from an external source (**XF105** only), the running mode will switch to [Rec Run] during special recording mode. When special recording mode is deactivated, the running mode will return to its previous setting.
- **XF105** During special recording mode, the time code signal will not be output from the GENLOCK/TC terminal or HD/SD SDI terminal.

## Frame Recording Mode

Set the number of frames in advance. We recommend using the wireless controller or stabilizing the camcorder, for example, on a tripod. Sound is not recorded in this mode. This mode is not available if [**Other Functions**] **Other Functions** [Bit Rate/Resolution] is set to [35 Mbps 1440x1080].

### Configuring Frame Recording Mode

- 1 Open the [Rec Frames] submenu.
  - [**Other Functions**] **Other Functions** [Frame Rec] **Frame Rec** [Rec Frames]
- 2 Select the desired number of frames and then press SET.
  - Available options are 2, 6 and 12.

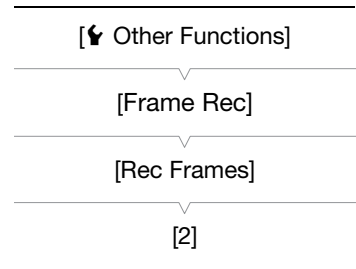

### Activating Frame Recording Mode and Recording

- 1 Open the [Special Rec] submenu.
  - [**Other Functions**] **Other Functions** [Special Rec]
- 2 Select [Frame Rec] and then press SET.
  - [FRM STBY] appears at the top of the screen (with [FRM] flashing).
- 3 Press the START/STOP button to begin recording.
  - The camcorder automatically records the set number of frames.
  - The tally lamps illuminate.
  - [FRM STBY] changes to [● FRM REC] while recording frames and [● FRM STBY] when frames are not being recorded.
  - Repeat until you finish recording.
- 4 Open the [Special Rec] submenu.
  - [**Other Functions**] **Other Functions** [Special Rec]

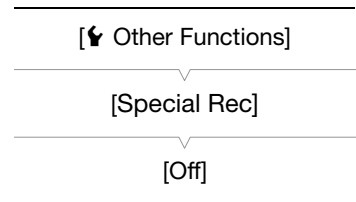

5 Select [Off] and then press SET.

- Frame recording mode ends and all of the recorded frames are joined together into one clip.
- The tally lamps go out and [STBY] appears at the top of the screen.

### **i** NOTES

- You can use only one special recording mode at a time.
- While recording, you cannot change the number of frames.
- Some frames at the point the recording was stopped may be recorded and added to the end of the clip.
- Frame recording mode will be deactivated if the special recording mode is changed or turned off. It will be deactivated also if you change the [**f** Other Functions] **o** [Bit Rate/Resolution] or [Frame Rate] setting.
- The time code advances by the number of frames recorded. If the running mode of the time code (**o** 69) is set to [Free Run] or the time code is input from an external source (**XF105** only), the running mode will switch to [Rec Run] during special recording mode. When special recording mode is deactivated, the running mode will return to its previous setting.
- **XF105** During special recording mode, the time code signal will not be output from the GENLOCK/TC terminal or HD/SD SDI terminal.

## Slow & Fast Motion Mode

When you set [**f** Other Functions] **o** [Frame Rate] to a progressive frame rate (**o** 45), the camcorder can record with a frame rate (shooting frame rate) that is different from the playback frame rate. Recording a clip at a higher frame rate than the [Frame Rate] setting will result in a slow motion effect during playback. Conversely, a lower frame rate will result in a fast motion effect.

Sound is not recorded in this mode. This mode is not available if [**f** Other Functions] **o** [Bit Rate/Resolution] is set to [35 Mbps 1440x1080].

### Configuring Slow & Fast Motion Mode

1 Open the [S&F Frame Rate] submenu.

[**f** Other Functions] **o** [Slow & Fast Motion] **o** [S&F Frame Rate]

2 Select the desired shooting frame rate and then press SET.

#### Available Shooting Frame Rates

12	15	18	20	21	22	23	24	25	26*
27*	28*	30*	32*	34*	37*	42*	45*	48*	50*

\* Available only when [**f** Other Functions] **o** [Bit Rate/Resolution] is set to [50 Mbps 1280x720] or [35 Mbps 1280x720].

### Activating Slow & Fast Motion Mode and Recording

1 Open the [Special Rec] submenu.

[**f** Other Functions] **o** [Special Rec]

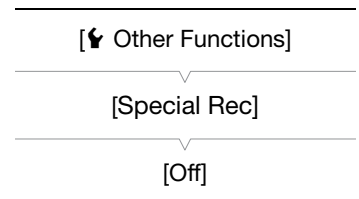
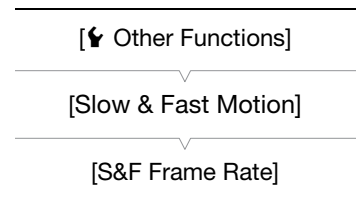

2 Select [Slow & Fast Motion] and then press SET.

- [S&F STBY] appears at the top of the screen.
- The selected shooting frame rate appears on the right side of the screen next to the [Other Functions] [Frame Rate] setting (the playback frame rate).

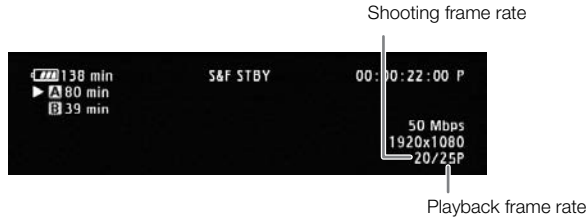

3 Press the START/STOP button to begin recording.

- The camcorder automatically records at the set frame rate.
- The tally lamps illuminate.
- [S&F STBY] changes to [S&F REC] while recording.

4 Press the START/STOP button again to stop recording.

- The camcorder records the clip.
- The tally lamps go out and [S&F STBY] appears at the top of the screen.

**i** NOTES

- You can use only one special recording mode at a time. In addition, slow & fast motion mode cannot be used with double slot recording.
- While recording, you cannot change the shooting frame rate.
- For lower shooting frame rates, it may take approximately 1 second to stop recording.
- Slow & fast motion mode will be deactivated if the special recording mode is changed or turned off. It will be deactivated also if you change the video configuration.
- The time code advances while video is recorded. If the running mode of the time code (69) is set to [Free Run] or the time code is input from an external source (XF105 only), the running mode will switch to [Rec Run] during special recording mode. When special recording mode is deactivated, the running mode will return to its previous setting.
- **XF105** During special recording mode, the time code signal will not be output from the GENLOCK/TC terminal or HD/SD SDI terminal.
- When the bit rate is set to 50 Mbps (45) during slow motion recording, relay recording is not available.

**Pre-recording Mode**

When pre-recording mode is activated, the camcorder starts recording continuously into a temporary memory of approximately 3 seconds so when you press the START/STOP button, the clip will contain also approximately 3 seconds of video and audio recorded before you pressed the button.

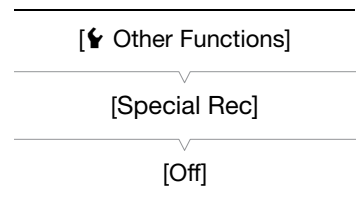

1 Open the [Special Rec] submenu.

- [Other Functions] [Special Rec]

2 Select [Pre Rec] and then press SET.

- [PRE REC STBY] appears at the top of the screen.

### 3 Press the START/STOP button to begin recording.

- The tally lamps illuminate.
- [PRE REC STBY] changes to [● PRE REC] while recording.

### 4 Press the START/STOP button again to stop recording.

- The camcorder records the clip, including approximately 3 seconds of video and audio recorded before the START/STOP button was pressed.
- The tally lamps go out and [PRE REC STBY] appears at the top of the screen.

#### NOTES

- You can use only one special recording mode at a time.
- Pre-recording mode will be deactivated if the special recording mode is changed or turned off. It will be deactivated also if you change the video configuration.
- During pre-recording mode, the time code will be recorded with the running mode ( 69) set to [Free Run], regardless of the previous setting. Alternatively, you can use an external time code signal (**XF105** only). When the time code is recorded, it will include the 3 seconds before the START/STOP button was pressed. When special recording mode is deactivated, the running mode will return to its previous setting.

## Infrared Recording

This camcorder features the ability to shoot movies in dark surroundings using the camcorder's infrared light and other sources of infrared light. Also, you can select whether the lighter areas of the picture appear in green or white.

Operating modes: CAMERA MEDIA

### Activating Infrared Mode

Follow the procedure below to set the camcorder to Infrared mode and to set the color of highlights in the picture.

- 1 Move the INFRARED switch to ON.
- 2 Open the [Monochrome] submenu to select a color.  
[Camera Setup] > [Infrared] > [Monochrome]
- 3 Select [White] or [Green] and then press SET.

#### **i** NOTES

- If you set an assignable button to [IR Monochrome] (📖 94), you can press the button to activate the infrared light.
- When you activate Infrared mode, autofocus will also be activated automatically. You can change the focus to manual focus during Infrared mode, however.
- Depending on the light source, autofocus may not work well.

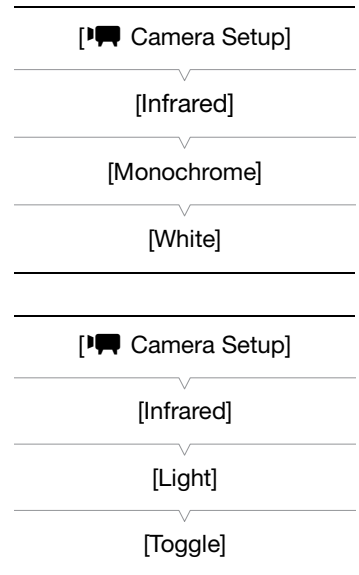
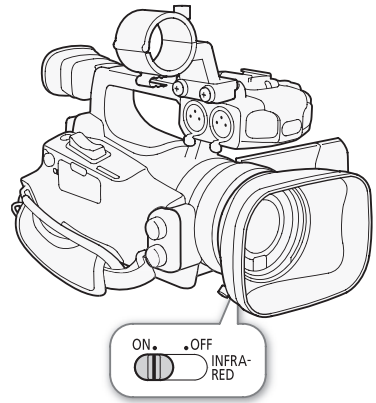

### Using the Infrared Light

You can turn the infrared light on and off using an assignable button or the CUSTOM button.

- 1 Open the [Light] submenu.  
[Camera Setup] > [Infrared] > [Light]
- 2 Select a desired option and then press SET.

#### Options

- [Toggle]: Allows you to turn the infrared light on and off using an assignable button or the CUSTOM button. Set an assignable button (📖 94) or CUSTOM button (📖 46) to [IR Light] in advance.
- [Always On]: The infrared light is always on while the camcorder is in Infrared mode.
- [Always Off]: The infrared light is always off.

---

**i** NOTES

- When the camcorder is in Infrared mode, the following adjustments are made automatically.
  - Gain, shutter speed and aperture are set to auto.
  - Autofocus is set to [Normal AF].
  - Light metering, AE level, AGC limit, white balance and custom picture cannot be set.
  - ND filter cannot be activated.
- When switching the camcorder to Infrared mode, do not point the lens at strong sources of light or heat. The camcorder's sensitivity to such sources is much higher than when shooting video normally. If there are such sources in the picture before you switch the camcorder to Infrared mode, shield the lens first.

## Optical Axis Shift

This function aids in a dual camera setup for 3D recording by allowing you to adjust the position of the image stabilization lens.

Operating modes: CAMERA MEDIA

### 1 Open the [OIS Functions] submenu.

[ Camera Setup] > [OIS Functions]

### 2 Select [Axis Shift] and then press SET.

- **Axis** appears on the bottom of the screen.

### 3 Open the optical axis [Adjust] screen.

[ Camera Setup] > [Axis Shift] > [Adjust]

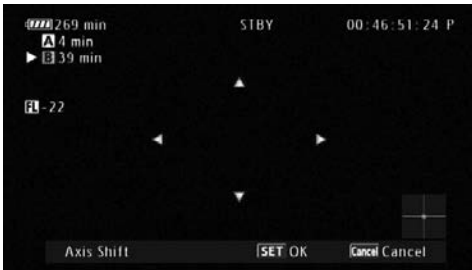

[ Camera Setup]

[OIS Functions]

[Img Stab.]

[ Camera Setup]

[Axis Shift]

[Adjust]

- Four directional icons appear on the screen. Use the joystick or wireless controller to adjust the picture. If the picture cannot be adjusted anymore in a particular direction, the corresponding directional icon will turn gray.
  - You can use the [ Camera Setup] > [Axis Shift] > [GUI Color] setting to change the color of the icons and the [Reset] setting to reset the position of the lens.
  - You can check the lens position using the display on the lower right of the screen.
- ### 4 Press SET when finished.
- If you press the CANCEL button, the lens will move back to its position prior to adjustment.

### NOTES

- The range of adjustment depends on the current zoom position.
- The more the lens position is adjusted, the bigger the deviation at the center of the picture will be during zoom. By centering on an object at full telephoto and then adjusting at full wide-angle, the amount of amount of deviation will be reduced.



## Using the Focal Length Guide

The focal length guide aids you when using two camcorders for 3D recording. The guide appears as a numerical value and has a range of 154 steps. You can set the guide to 0 at any point in the zoom range to help precisely calibrate both camcorders.

Operating modes: CAMERA MEDIA

1 Set up two camcorders and align their picture angle.

2 Open the [Focal Length Guide] submenu.

[ Camera Setup] [Zoom] [Focal Length Guide]

3 Select [Set To 0] and then press SET.

- The focal length guide appears on the left side of the screen as [**FL** ±0]. To turn off the indicator, select [Off] instead.
- You can obtain more accurate results by performing this step at full telephoto.
- If both camcorders are set so that the same value is displayed during zoom, the focal length for both camcorders will be maintained.

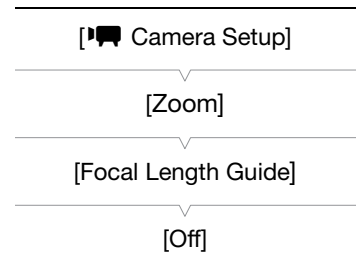

### NOTES

- Although the focal length guide is an aid for 3D recording, make sure to check the picture angle visually while recording.

## Assignable Buttons

The camcorder conveniently features 10\* buttons to which you can assign various functions. By assigning often-used functions, you can quickly access them with a single press of a button.

\* In **MEDIA** mode, only assignable buttons 1 to 4 are available.

Operating modes: **CAMERA** **MEDIA**

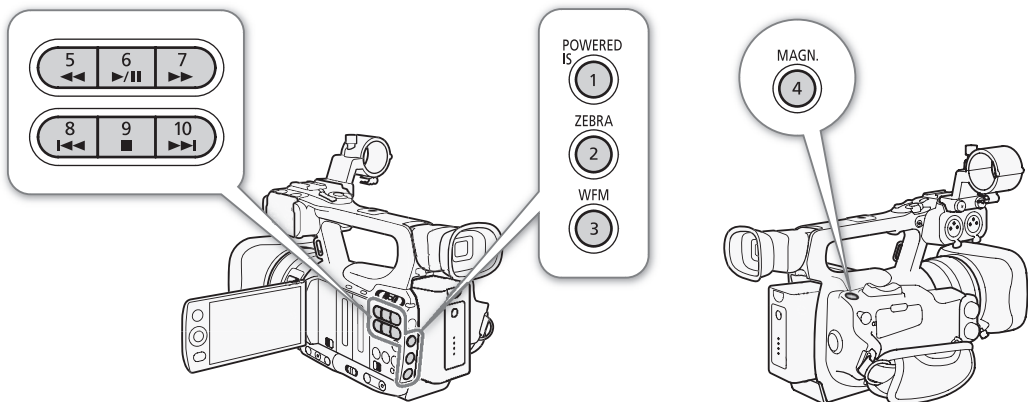

### Changing the Assigned Function

1 Open the [Assign Button] submenu.

[**Other Functions**] ► [Assign Button]

2 Select the button to change and then press SET.

- A list of available functions appears.
- The quick reference shows the default settings for each assignable button. By default, buttons 5 to 10 have no assignable function set.

3 Select the desired function and then press SET.

- You can check the [Buttons / Remote] status screen (📖 151) to see what functions are set for the assignable buttons.
- You can use the [**Other Functions**] ► [Reset] ► [Assignable Buttons] setting to reset the assignable buttons to their default settings.

[**Other Functions**]

[Assign Button]

[1 Powered IS]  
 [2 Zebra]  
 [3 WFM (LCD)]  
 [4 Magnification]  
 [5-10 (NONE)]

## Using an Assignable Button

After you assign a function to one of the buttons, press the button to activate the function. For some functions, an options menu may appear. In such case, select the desired option and then press SET.

### Assignable Functions

Functions can be set separately in **CAMERA** mode and **MEDIA** mode. Refer to the following table for assignable functions and available modes.

Function name	Description	CAMERA	MEDIA	
[Img Stab.]	Turns the selected image stabilization method (Dynamic IS or Standard IS) on/off.	●	–	52
[Powered IS]	Turns Powered IS on/off.	●	–	52
[Focus Limit]	Turns the focus limit on/off.	●	–	51
[Face AF]	Toggles the autofocusing between [Face Pri.], [Face Only] and [Off].	●	–	50
[Select Face]	Selects the main subject when using [Face AF] to focus on subjects' faces.	●	–	50
[Backlight]	Turns the backlight light metering option on/off.	●	–	58
[Spotlight]	Turns the spotlight light metering option on/off.	●	–	58
[Tele-converter]	Activates the digital tele-converter in the following sequence: 1.5x → 3x → 6x → Off	●	–	140
[Peaking]	Turns peaking on/off.	●	–	48
[Zebra]	Turns zebra patterns on/off.	●	–	68
[WFM (LCD)]	Activates video scopes in the following sequence: Waveform monitor → Edge monitor → Off	●	●	81
[Magnification]	Turns magnification on/off.	●	–	49
[TL-H58]	Sets the  Camera Setup  [Conversion Lens] setting to [TL-H58] or [Off].	●	–	66
[WD-H58W]	Sets the  Camera Setup  [Conversion Lens] setting to [WD-H58W] or [Off].	●	–	66
[Color Bars]	Turns color bars on/off.	●	–	80
[IR Monochrome]	Switches between white and green when the camcorder is in Infrared mode.	●	–	90
[IR Light]	Turns the infrared light on/off when  Camera Setup  [Infrared]  [Light] is set to [Toggle].	●	–	90
[Markers]	Turns onscreen markers on/off.	●	–	67
[LCD Setup]	Opens the [LCD Setup] submenu.	●	●	30
[LCD/VF B&W]	Turns the B&W mode of the LCD and viewfinder on/off.	●	●	31
[Onscreen Display]	Displays the onscreen icons and text on an external monitor (for both SD and HD output).	●	●	125
[Shot Mark 1]	Adds an  mark to the clip.	●	●	83
[Shot Mark 2]*	Adds an  mark to the clip.	●	●	83
[Add  Mark]	Adds an  mark to the clip.	●	●	115
[Add  Mark]	Adds a  mark to the clip.	●	●	115
[Time Code]	Displays the [Time Code] submenu.	●	–	69
[Time Code Hold]*	Puts the time code display on hold or resumes it.	●	●	69
[Audio Output CH]	Switches the audio output channel.	●	●	126
[Audio Level]	Turns the audio level meter on/off.	●	●	78
[Wireless Controller]	Turns the wireless controller on/off.	●	●	32
[Photo]**	Records a photo.	●	●	132
[Delete Last Clip]	Deletes the last clip recorded.	●	–	117
[Status]*	Displays the status screens.	●	●	150

\* Function can be used only by assigning it to a button.

\*\*Function can be used only by assigning it to a button or by using the PHOTO button on the wireless controller.

## Custom Picture Settings

You can preset a number of picture-related settings. After changing individual settings to your preference, you can save the whole set in the camcorder or SD card as a custom picture file. You can then load the file at a later date to change the current settings to the preset levels you selected. You can even embed the custom picture settings in clips recorded to a CF card or photos recorded to an SD card. Conversely, you can have the camcorder record clips and photos without embedding custom picture settings.

You can save up to 9 different custom picture files on the camcorder and up to 20 custom picture files on an SD card. Custom picture files can be copied between the camcorder and recording media.

Custom preset files created with previous Canon camcorders are not compatible with this camcorder. Custom picture files created with this camcorder are compatible with only the XF105 and XF100.

Operating modes: CAMERA MEDIA

### Available custom picture settings

Category	Menu item	Submenu	📖
Settings related to light and dark tones	[Gamma]		99
	[Black Gamma]		100
	[Black]	[Master Pedestal]	99
		[Master Black]	99
	[Knee]	All settings except [Saturation]	100
	[Other Functions]	[Setup Level]	103
[Clip at 100%]		103	
Settings related to sharpness and noise	[Sharpness]		101
	[Noise Reduction]		101
	[Skin Detail]		101
	[Selective NR]		102
Settings related to color	[Low Key Satur.]		100
	[Knee]	[Saturation] setting	100
	[Color Matrix]		102
	[White Balance]		102
	[Color Correction]		103

### Selecting Custom Picture Files

Select a custom picture file to apply its settings to your recordings or to edit, rename, protect, or transfer it.

**1** Open the [Custom Picture] submenu.

[📷] Camera Setup ➤ [Custom Picture]

**2** Select [ $\overline{\text{SET}}$ ] [CP] Select File] and then press SET.

- A list of custom picture files in the camcorder and SD card appears. Files in the camcorder begin with [C1] to [C9]; those on the SD card begin with [SD1] to [SD20].

**3** Select the desired file and then press SET.

- To apply the file's settings, press the MENU button to exit the menu. An icon representing the selected custom picture file will appear on the left side of the screen.
- To perform other operations on the file, continue with the following procedures.
- Select [Off] to record without applying the custom picture file's settings.

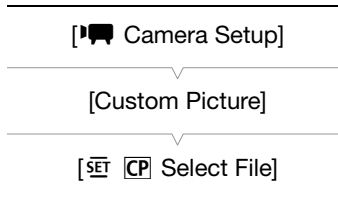

### Preset Custom Picture Files

By default, the custom picture files in the camcorder in file slots [C7] to [C9] are protected. Remove the protection (📖 97) to edit the file. The following describes when to use the preset files.

[C7 VIDEO.C]: For playing back video on consumer flat-panel displays.

[C8 CINE.V]: For achieving a cinema-like picture on TV monitors, such as when creating TV programs that require a cinema-like effect.

[C9 CINE.F]: When combined with [Cine 2] (under [Gamma]) and [Cine 2] (under [Color Matrix] ⌚ [Select]), creates a cinema-like effect different from that of [C8 CINE.V].

### Editing a Custom Picture File's Settings

- 1 After selecting a file, select [🔍 CP Edit File] and then press SET.
- 2 Select a setting and then press SET.
- 3 Change the setting to the desired level.
  - Refer to *Available Custom Picture Settings* (📖 99) for details on the various settings.
  - Repeat steps 2 and 3 for other settings, as necessary.
- 4 Press the MENU button to exit the menu.

### Renaming Custom Picture Files

- 1 After selecting a file, open the [Rename] submenu.
  - [🔍 CP Edit File] ⌚ [Rename]
    - A screen appears that displays the current file name with an orange selection frame on the first character.
- 2 Select an alphanumeric character or symbol then move (▶) to the next field.
  - Change the rest of the name in the same way.
- 3 Select [Set] and then press SET.
- 4 Press the MENU button to exit the menu.

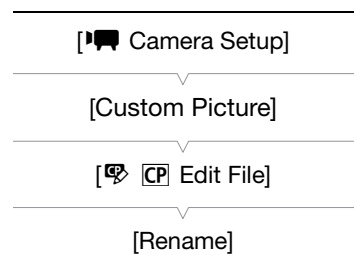



### Protecting Custom Picture Files

Protecting a custom picture file prevents its settings from being accidentally changed.

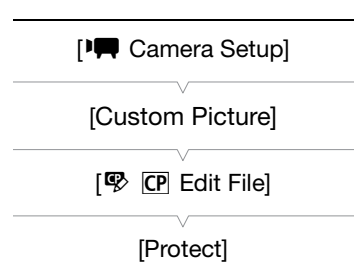



- 1 After selecting a file, open the [Protect] submenu.
  - [🔍 CP Edit File] ⌚ [Protect]
- 2 Select [Protect] and then press SET.
  - In the file selection list, 🛡️ will appear next to the file name.
  - To remove protection settings, select [Unprotect] instead.
- 3 Press the MENU button to exit the menu.







## Transferring Custom Picture Files

You can transfer custom picture files between the camcorder and SD card. When the custom picture file is in the camcorder, use [Copy To ] or [Load From ] depending on the operation you wish to perform. Similarly, when the custom picture file is on an SD card, use [Copy To Cam.] or [Load From Cam.].



### Copying a File from the Camcorder to an SD Card

- 1 After selecting a file in the camcorder, open the [Copy To ] submenu.  
 [  Transfer File]  [Copy To - If there are available slots, you can select [New File] to save the file in the first available slot.
- 3 Select [OK] and then press SET.
  - The currently selected file will be copied to the selected slot on the SD card, overwriting the file in that slot.
- 4 Press the MENU button to exit the menu.



### Replacing a File in the Camcorder with a File on an SD Card

- 1 After selecting a file in the camcorder to replace, open the [Load From ] submenu.  
 [  Transfer File]  [Load From 
- 4 Press the MENU button to exit the menu.

### Copying a File from an SD Card to the Camcorder

- 1 After selecting a file on the SD card, open the [Copy To Cam.] submenu.  
 [  Transfer File]  [Copy To Cam.]
- 2 Select the file slot under which to save the file and then press SET.
- 3 Select [OK] and then press SET.
  - The currently selected file will be copied to the selected slot on the camcorder, overwriting the file in that slot.
- 4 Press the MENU button to exit the menu.

### Replacing a File on an SD Card with a File in the Camcorder

- 1 After selecting a file on the SD card to replace, open the [Load From Cam.] submenu.  
 [  Transfer File]  [Load From Cam.]
- 2 Select the file to transfer to the SD card and then press SET.
- 3 Select [OK] and then press SET.
  - The file on the SD card will be overwritten by the one on the camcorder.
- 4 Press the MENU button to exit the menu.

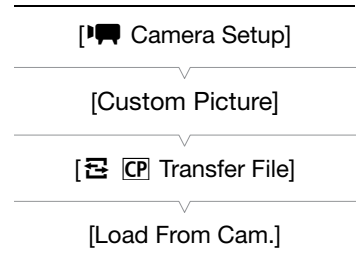
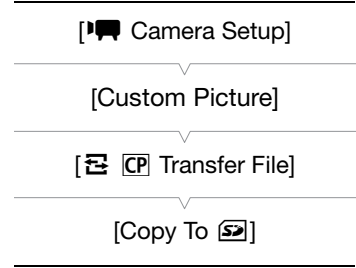

**i** NOTES

- You can also copy a custom picture file embedded in a clip to the camcorder (118).

### Embedding Custom Picture Settings in a Recording

You can record video or take a photo with your custom picture settings applied to it. Later, those embedded settings in the video or photo can be copied to the camcorder (137) and be applied to future recordings. You may find that embedding custom picture settings in a recording helps you keep track of them, such as verifying what settings were used for a particular recording.

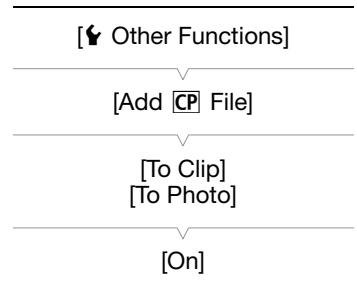

1 Open the [Add CP File] submenu.

[Other Functions] → [Add CP File]

2 Select [To Clip] or [To Photo] and then press SET.

- Selecting [To Clip] will embed the custom picture file in a clip while selecting [To Photo] will embed the file in a photo.

3 Select [On] and then press SET.

### Available Custom Picture Settings

The following are the available settings. Even if no custom picture file is selected, the default settings are still applied to the picture.

#### Gamma

The gamma curve changes the overall look of the image.

(Default: [Normal 1])

[Normal 1] to [Normal 4]: These settings are suitable for viewing the image on a TV monitor. Highlights in [Normal 2] are brighter than those of [Normal 1]. Dark tones in the lower part of the gamma curve for [Normal 3] (ITU-R BT.709 standard) and [Normal 4] are more pronounced than those of [Normal 2].

[Cine 1] or [Cine 2]:

Use [Cine 1] for a gamma curve that results in a picture with a cinema-like feel and cinema-like tones. [Cine 2] has softer contrasts than does [Cine 1] but is also suitable for creating a cinema-like picture.

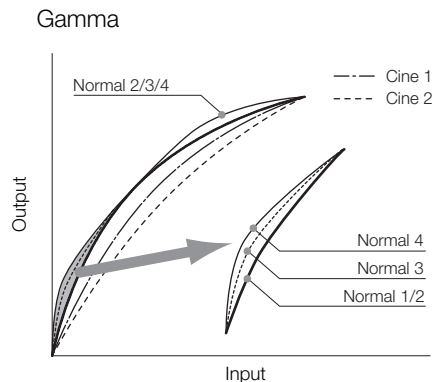

#### Black

Controls the black level and color cast of blacks.

##### Master Pedestal

The master pedestal increases or decreases the black level. Higher settings will make dark areas brighter but decrease contrast. This setting can be adjusted from -50 to 50. (Default: 0)

### Master Black

Corrects color cast in blacks.

[Red]: -50 to 50 (Default: 0)

[Green]: -50 to 50 (Default: 0)

[Blue]: -50 to 50 (Default: 0)

### Black Gamma

Controls the lower part of the gamma curve (dark areas of the image).

[Level]: Raises or lowers the lower part of the gamma curve. This setting can be adjusted from -50 to 50. (Default: 0)

[Range]: Selects the range in which dark areas are affected. This setting can be adjusted from -5 to 50. (Default: 0)

[Point]: Determines the shape of the lower part of the gamma curve. This setting can be adjusted from -1 to 50. (Default: 0)

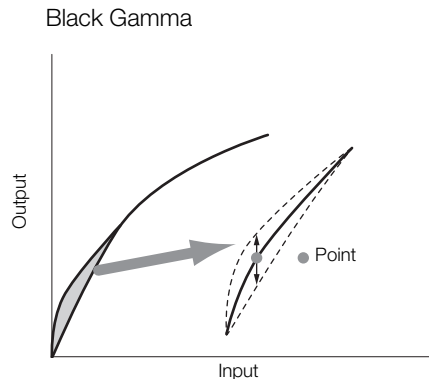

### Low Key Saturation

Adjusts color saturation in dark areas.

[Enable]: Activates/deactivates the setting. (Default: [Off])

[Level]: Specifies how saturated colors are in dark areas. This setting can be adjusted from -50 to 50. (Default: 0)

### Knee

Controls the upper part of the gamma curve (highlights of the image). By compressing the highlights, you can prevent parts of the image from being overexposed. This is not available when [Gamma] is set to [Cine 1] or [Cine 2].

[Enable]: Activates/deactivates the setting. (Default: [On])

[Automatic]: Select [On] to have the camcorder automatically set the knee point and slope to prevent images being overexposed so quickly. Select [Off] to manually adjust the knee point. (Default: [On])

[Slope]: Determines the slope of the gamma curve above the knee point. This setting can be adjusted from -35 to 50. (Default: 0)

[Point]: Sets the knee point of the gamma curve. This setting can be adjusted from 50 to 109. (Default: 95)

[Saturation]: Adjusts color saturation in highlights when [Automatic] is set to [Off]. This setting can be adjusted from -10 to 10. (Default: 0)

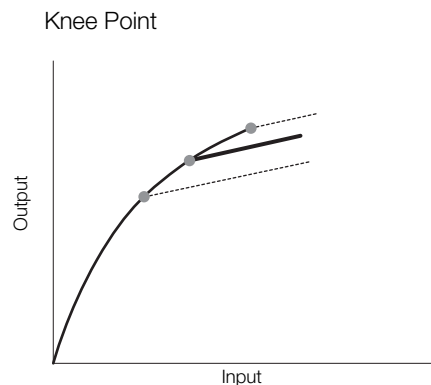
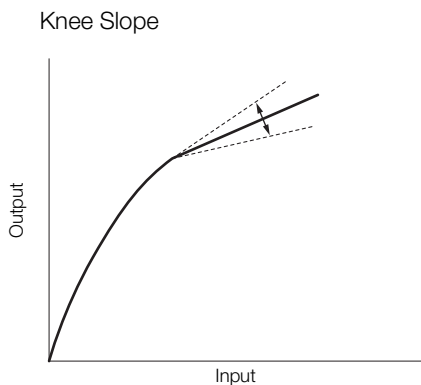



## Sharpness

Sets the sharpness of the output and recording signal.

- [Level]: Sets the sharpness level. This setting can be adjusted from -10 to 50. (Default: 0)
- [H Detail Freq.]: Sets the center frequency of horizontal sharpness. Setting higher values increases the frequency, which, in turn, increases the sharpness. This setting can be adjusted from -8 to 8. (Default: 0)
- [Coring]: Reduces noise artifacts caused by high sharpness levels.
- [Level]: Sets the coring level. Higher values prevent sharpness from being applied to minute details, resulting in less noise. This setting can be adjusted from -30 to 50. (Default: 0)
- [D-Ofst]: You can use [D-Ofst], [D-Curve] and [D-Depth] to adjust the coring level based on brightness. [D-Ofst] sets the coring level of the minimum brightness level. This setting can be adjusted from 0 to 50. (Default: 0)
- [D-Curve]: Sets the curve of the coring adjustment. This curve is the change from [Level] to [D-Ofst]. This setting can be adjusted from 0 to 8. (Default: 0)
- [D-Depth]: Sets a multiplier to [D-Ofst] that determines the coring level adjustment based on brightness. Positive values raise the coring level in dark areas and negative values lower the level. This setting can be adjusted from -4 to 4. (Default: 0)
- [HV Detail Bal.]: Adjusts the ratio between horizontal and vertical detail. Higher values emphasize vertical detail while lower values emphasize horizontal detail. This setting can be adjusted from -8 to 8. (Default: 0)
- [Limit]: Restricts how much sharpness is applied. This setting can be adjusted from -50 to 50. (Default: 0)
- [Knee Aperture]: Allows you to set the sharpness of only the areas above the knee point by adjusting the gain and slope. This is not available when [Gamma] is set to [Cine 1] or [Cine 2].
- [Gain]: Sets the amount of sharpness. This setting can be adjusted from 0 to 9. (Default: 0)
- [Slope]: Sets the slope of the sharpness. This setting can be adjusted from 0 to 3, with 0 having no slope, 1 having a steep slope and 3 having a gradual slope. (Default: 1)
- [Level Depend]: Lowers the amount of sharpness applied to dark areas of the image.
- [Level]: Sets the brightness of the dark areas of the image that will be affected. This setting can be adjusted from 0 to 50. (Default: 0)
- [Slope]: Determines the slope of the area between the upper and lower parts of the gamma curve. This setting can be adjusted from 0 to 3, with 0 having no slope, 1 having a steep slope and 3 having a gradual slope. (Default: 0)
- [Offset]: Adjusts the sharpness level of dark areas in the image. Setting higher values will lower the sharpness level. This setting can be adjusted from 0 to 50. (Default: 0)
- [Ingredient Ratio]: Changing this ratio allows you to affect the balance between resolution and the reduction of jagged edges. Higher values emphasize resolution while lower values emphasize the reduction of jagged edges. This setting can be adjusted from -50 to 50. (Default: 0)

## Noise Reduction

Reduces the amount of noise that appears in the image. Select [Automatic] to have the camcorder adjust the noise automatically. Otherwise, select a level from 1 (lowest level) to 8 (highest level), or select [Off] to turn the noise reduction off. (Default: [Automatic])

## Skin Detail

The camcorder applies a softening filter to areas in the picture with skin tones to give a more pleasant appearance. By changing these settings, you can determine what areas will be detected as skin tones. A zebra pattern will appear over areas on the LCD screen that are detected as having skin tones.

- [Effect Level]: Adjusts the level of the filter. The available options are [Off], [Low], [Middle] and [High]. (Default: [Off])
- [Hue]: Adjusts the hue for detection of skin tones. This setting can be adjusted from -16 to 16. (Default: 0)

- [Chroma]: Adjusts the color saturation for detection of skin tones. This setting can be adjusted from 0 to 31. (Default: 16)
- [Area]: Adjusts the color range for detection of skin tones. This setting can be adjusted from 0 to 31. (Default: 16)
- [Y Level]: Adjusts the brightness for detection of skin tones. This setting can be adjusted from 0 to 31. (Default: 16)

### Selective Noise Reduction

The camcorder detects the characteristics of a certain color or tone and applies a noise reduction filter to the targeted areas. A zebra pattern will appear over targeted areas on the screen.

- [Effect Level]: Adjusts the level of the noise reduction filter. The available options are [Off], [Low], [Middle] and [High]. (Default: [Off])
- [Hue]: Adjusts the hue for the color to be detected. This setting can be adjusted from 0 to 31. (Default: 0)
- [Chroma]: Adjusts the color saturation for the color to be detected. This setting can be adjusted from 0 to 31. (Default: 16)
- [Area]: Adjusts the color range for the color to be detected. This setting can be adjusted from 0 to 31. (Default: 16)
- [Y Level]: Adjusts the brightness for the color to be detected. This setting can be adjusted from 0 to 31. (Default: 16)

### Color Matrix

Color matrix affects the color tones throughout the whole image.

- [Select]: Available options are [Normal 1] to [Normal 4], [Cine 1] and [Cine 2]. Generally, this is the same setting as [Gamma]. After selecting an option, you can make more precise adjustments. (Default: [Normal 1])
- [Gain]: Adjusts the color intensity. This setting can be adjusted from -50 to 50. (Default: 0)
- [Phase]: Adjusts the color phase. This setting can be adjusted from -18 to 18. (Default: 0)
- [R-G]: The R-G matrix changes the tint of the picture along the cyan/green and red/magenta gradations. This setting can be adjusted from -50 to 50. (Default: 0)
- [R-B]: The R-B matrix changes the tint of the picture along the cyan/blue and red/yellow gradations. This setting can be adjusted from -50 to 50. (Default: 0)
- [G-R]: The G-R matrix changes the tint of the picture along the magenta/red and green/cyan gradations. This setting can be adjusted from -50 to 50. (Default: 0)
- [G-B]: The G-B matrix changes the tint of the picture along the magenta/blue and green/yellow gradations. This setting can be adjusted from -50 to 50. (Default: 0)
- [B-R]: The B-R matrix changes the tint of the picture along the yellow/red and blue/cyan gradations. This setting can be adjusted from -50 to 50. (Default: 0)
- [B-G]: The B-G matrix changes the tint of the picture along the yellow/green and blue/magenta gradations. This setting can be adjusted from -50 to 50. (Default: 0)

### White Balance

Adjusts the amount of white balance throughout the whole image.

- [R Gain]: Adjust the intensity of red tones. This setting can be adjusted from -50 to 50. (Default: 0)
- [G Gain]: Adjust the intensity of green tones. This setting can be adjusted from -50 to 50. (Default: 0)
- [B Gain]: Adjust the intensity of blue tones. This setting can be adjusted from -50 to 50. (Default: 0)

## Color Correction

The camcorder detects the characteristics of a certain color (color phase, chroma, area and Y level) and corrects them when recording. You can set the color correction for up to two different areas (A and B).

[Select Area]: Selects the area or areas to correct. Available options are [Area A], [Area B] and [Area A&B]. Select [Off] to turn this setting off. (Default: [Off])

[Area A Setting]: Determines the area in which colors will be corrected.

[Phase]: Adjusts the color phase for area A. This setting can be adjusted from 0 to 31. (Default: 0)

[Chroma]: Adjusts the color saturation for area A. This setting can be adjusted from 0 to 31. (Default: 16)

[Area]: Adjusts the color range for area A. This setting can be adjusted from 0 to 31. (Default: 16)

[Y Level]: Adjusts the brightness for area A. This setting can be adjusted from 0 to 31. (Default: 16)

[Area A Revision]: Sets the amount of correction for area A.

[Level]: Adjusts the amount of correction to the color saturation. This setting can be adjusted from -50 to 50. (Default: 0)

[Phase]: Adjusts the amount of correction to the color phase. This setting can be adjusted from -18 to 18. (Default: 0)

[Area B Setting]: Determines the area in which colors will be corrected.

[Phase]: Adjusts the color phase for area B. This setting can be adjusted from 0 to 31. (Default: 0)

[Chroma]: Adjusts the color saturation for area B. This setting can be adjusted from 0 to 31. (Default: 16)

[Area]: Adjusts the color range for area B. This setting can be adjusted from 0 to 31. (Default: 16)

[Y Level]: Adjusts the brightness for area B. This setting can be adjusted from 0 to 31. (Default: 16)

[Area B Revision]: Sets the amount of correction for area B.

[Level]: Adjusts the amount of correction to the color saturation. This setting can be adjusted from -50 to 50. (Default: 0)

[Phase]: Adjusts the amount of correction to the color phase. This setting can be adjusted from -18 to 18. (Default: 0)

## Other Functions

[Setup Level]: Adjusts the black level set by the [Black] and [Master Pedestal] settings.

[Level]: Determines the amount of adjustment to be made. This setting can be adjusted from -50 to 50. (Default: 0)

[Press]: Compresses the dynamic range of the video signal so that it does not exceed 100%. Available options are [On] and [Off]. (Default: [Off])

[Clip At 100%]: When the video signal exceeds 100%, this function clips the white level at 100%. (Default: [Off])

## Customizing Functions and Onscreen Displays

Customize the camcorder to match your shooting style and needs. Use the [ Other Functions] [Custom Function] setting to adjust how some of the camcorder's controls and functions operate in **CAMERA** mode. Similarly, use the [ LCD/VF Setup] [Custom Display] setting to customize the onscreen displays that appear during recording. You can save these preferences along with other menu settings to an SD card and use them again later ( 106).

### Customizing Functions

The following table describes which functions can be customized using [Custom Function]. For more details, refer to [*Custom Function*] ( 148).

Operating modes: **CAMERA** **MEDIA**

- 1 Open the [Custom Function] submenu.  
 Other Functions] [Custom Function]
- 2 Select the desired function.
- 3 Change the setting option and then press SET.

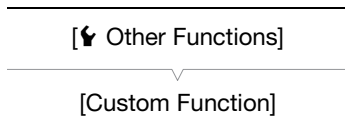

#### Customizable Functions with [Custom Function]

Menu item	Description
[Shockless Gain]	Determines the speed of the transition when the gain is changed.
[Shockless WB]	Creates a softer transition when the white balance is changed.
[AE Response]	Controls the camcorder's response when you change the automatic exposure setting.
[Iris Limit]	Sets a maximum aperture value (F8.0) to be used for shooting.
[I. Ring Direction]	Changes the direction of the adjustment when turning the manual ring while it is set to IRIS(ND).
[F. Ring Direction]	Changes the direction of the adjustment when turning the manual ring while it is set to FOCUS.
[Z. Ring Direction]	Changes the direction of the adjustment when turning the manual ring while it is set to ZOOM.
[F. Ring Control]	Selects the sensitivity of the response when operating the manual ring while it is set to FOCUS.
[Z. Ring Control]	Selects the sensitivity of the response when operating the manual ring while it is set to ZOOM.
[F. Assist B&W]	Automatically switches the screen to B&W while the focus assist functions (peaking and magnification) are activated. You can have the screen switch to B&W when only the peaking is activated, when only the magnification is activated or when both are activated. Focus assist functions will not appear on an external monitor.
[Obj. Dist. Unit]	Selects the units of distance (meters or feet) displayed when the camcorder shows the distance to the subject in manual focus mode.
[Zoom Indicator]	Selects the display of the zoom indicator between a graphic bar and a numeric display (0 to 99).
[ZR-2000 AE SHIFT]	Selects the function of the AE SHIFT dial on the optional ZR-2000 Zoom Remote Controller between adjusting either the exposure compensation or the aperture value.
[Scan Reverse Rec]	Inverts the recorded image horizontally, vertically or horizontally and vertically.
[Character Rec]	When this function is set to [On], all of the onscreen displays will be recorded to the clip exactly as they appear on the screen.

## Customizing Onscreen Displays

By customizing onscreen displays, you can choose to have the camcorder display some icons while hiding other ones. For details on which onscreen displays can be customized, refer to *Onscreen Displays* (📖 42). For details on the setting options, refer to *[Custom Display 1]* (📖 144) and *[Custom Display 2]* (📖 144).

Operating modes:

- 1 Open the [Custom Display 1] or [Custom Display 2] submenu.  
[ LCD/VF Setup] ➤ [Custom Display 1] or [Custom Display 2]
- 2 Select the desired onscreen display.
- 3 Change the setting option and then press SET.

---

[ LCD/VF Setup]

---

[Custom Display 1]  
[Custom Display 2]

---





# Saving and Loading Camera Settings

After you adjust settings in the menus, you can save those settings on an SD card. You can load those settings at a later date or on another XF105 or XF100 camcorder so that you can use that camcorder in the same exact way.

Operating modes: CAMERA MEDIA

## Saving Camera Settings to an SD Card

1 Open the [Save To ] submenu.

[ Other Functions]  [Transfer Menu]  [Save To ]

2 Select [OK] and press SET.

- The current settings are saved to the SD card. If the SD card already has camera settings on it, they will be overwritten.

3 When the confirmation screen appears, press SET.

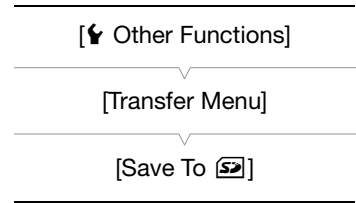

## Loading Camera Settings from an SD Card

Make sure an SD card with camera settings to be loaded is inserted in the camcorder.

1 Open the [Load From ] submenu.

[ Other Functions]  [Transfer Menu]  [Load From ]

2 Select [OK] and press SET.

- After the camcorder's current settings are replaced with the settings saved on the SD card, the screen will turn black momentarily and the camcorder will restart.

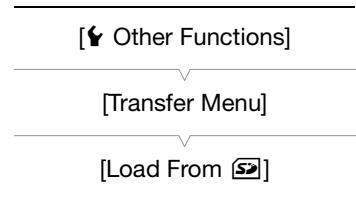

### NOTES

- The SD card includes a text file that lists the camera settings. You can check the settings by using a USB card reader to access the SD card on a computer. In the [CAMSET] folder, open the file "CAMSET2.TXT".
- The camera settings can be used with other XF105 and XF100 camcorders. However, camera settings from Canon XF305 and XF300 camcorders cannot be used with this camcorder.
- When loading camera settings from an SD card, even protected custom picture settings in the camcorder will be replaced.

## Playback

This section explains how to play back clips recorded on a CF card. For details on playing back clips using an external monitor, refer to *Connecting to an External Monitor* (📖 123). For details on viewing photos on the SD card, refer to *Viewing Photos* (📖 134).

Operating modes:  CAMERA  MEDIA

### Clip Index Screen

Playback functions are accessed from the clip index screen. To open the clip index screen, set the camcorder to  MEDIA mode.

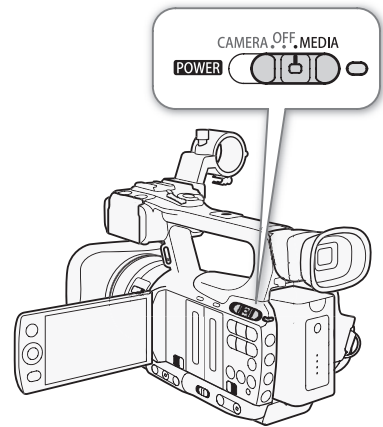

Hold down the button on the **POWER** switch and move it to **MEDIA**.

- The camcorder switches to **MEDIA** mode and the clip index screen appears.

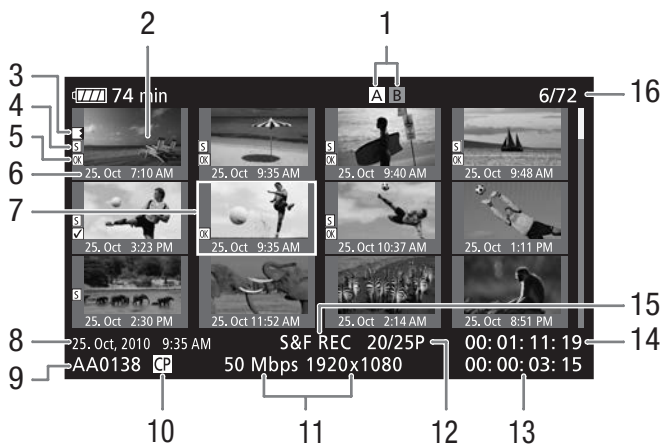

- |   |  |    |                                     |
|---|--|----|-------------------------------------|
| 1 | Currently selected CF card slot ( 37)  | 9  | Clip name ( 41)                     |
| 2 | Clip thumbnail ( 120)  | 10 | Embedded custom picture file ( 96)  |
| 3 | Relay recording: Appears when a clip begins on one CF card and continues on the other. ( 38) | 11 | Bit rate and resolution ( 45)       |
| 4 | Shot mark ( 83, 112)   | 12 | Frame rate                          |
| 5 | mark/ mark ( 115)  | 13 | Total recording time                |
| 6 | Recording date (month and day only) and time   | 14 | Time code of thumbnail              |
| 7 | Orange selection frame   | 15 | Special recording mode ( 85)        |
| 8 | Recording date and time  | 16 | Clip number / Total number of clips |

### Switching Between the CF Card Slots

If both CF card slots contain a CF card, you can switch between them as necessary.

Operating modes: **CAMERA** **MEDIA**

Press the **SLOT SELECT** button.

- The access indicator of the selected CF card slot will illuminate in green.

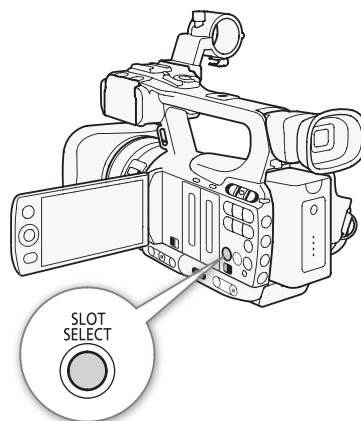



## Switching to Other Index Screens

All of the clips on a CF card can be accessed from the clip index screen. However, you can switch to other index screens that show only clips with an **[OK]** mark ([**OK**] Mark] index screen), clips with a **[✓]** mark ([**✓**] Mark] index screen), or photos\* ([Photos] index screen).

\* Photos are saved on the SD card.

- 1 Press the INDEX button.
  - The index screen selection menu appears.
- 2 Select the desired index screen and then press SET.
  - The selected index screen appears.
  - Select [Cancel] instead to cancel the operation.
  - Press the INDEX button again to return to the clip index screen.

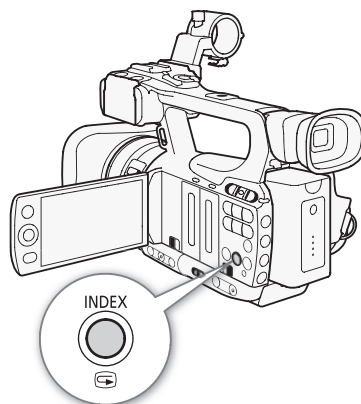

## Playing Back Clips

You can play back clips from the clip index screen, [**OK**] Mark] index screen and [**✓**] Mark] index screen. Use the playback control buttons shown in the illustration.

- 1 Move the orange selection frame to the clip you want to play back.
- 2 Press the **▶/||** button to start playback.
  - Playback will start from the clip selected and continue until the end of the last clip in the index screen. When the last frame of the last clip is reached, playback will be paused.
  - Press the **▶/||** button again to pause the playback.
  - Press the **■** button to stop the playback and return to the index screen.

### ! IMPORTANT

- Observe the following precautions while the CF **A** or CF **B** access indicator is illuminated in red. Failure to do so may result in permanent data loss.
  - Do not disconnect the power source or turn off the camcorder.
  - Do not open the cover of the CF card slot being accessed.

### i NOTES

- You may notice brief stops in video or audio playback between clips.

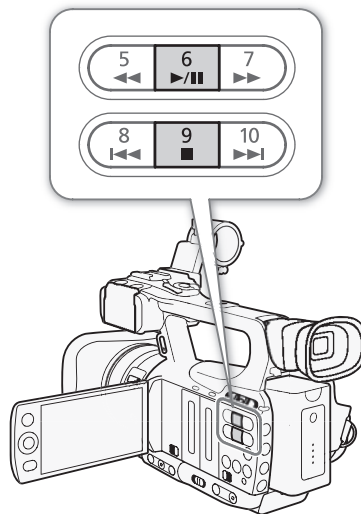

## Onscreen Displays

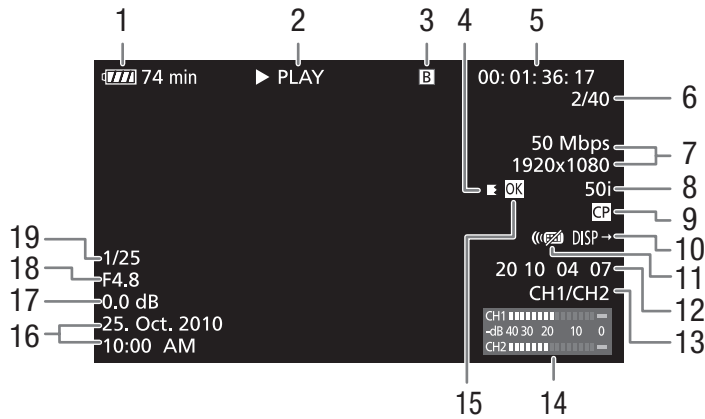

- |                                       |   |
|---------------------------------------|---|
| 1 Remaining battery time (📖 43)       | 11 Wireless controller (📖 144)          |
| 2 Playback operation                  | 12 User bit (📖 71)                      |
| 3 Selected CF card                    | 13 Audio output channel (📖 126)         |
| 4 Relay recording                     | 14 Audio level meter (📖 143)            |
| 5 Time code (📖 69)                    | 15  mark/ mark (📖 115)                  |
| 6 Clip number / Total number of clips | 16 Recording date and time <sup>1</sup> |
| 7 Bit rate and resolution (📖 45)      | 17 Gain <sup>2</sup> (📖 53)             |
| 8 Frame rate (📖 45)                   | 18 Aperture value <sup>2</sup> (📖 57)   |
| 9 Embedded custom picture file (📖 96) | 19 Shutter speed <sup>2</sup> (📖 55)    |
| 10 Output displays (📖 125)            |   |

<sup>1</sup> Appears when  [LCD/VF Setup]  [Metadata Display]  [Date/Time] is set to [On].  
<sup>2</sup> Appears when  [LCD/VF Setup]  [Metadata Display]  [Camera Data] is set to [On].

### 2 Playback operation

- |  |                             |
|--|-----------------------------|
|  | Playback                    |
|  | Playback pause              |
|  | Frame reverse/Frame advance |
|  | Fast playback*              |
|  | Fast reverse playback*      |

\* The playback speed (x5, x15 or x60) will also appear in the indicator.

### 4 Relay recording

Appears when a clip begins on one CF card and continues uninterrupted on the other. indicates the first part of the recording, indicates the middle part(s) and indicates the last part.

## Playback Controls

When you play back a clip, operate the buttons on the camcorder or the wireless controller to use fast playback, play back frame-by-frame or skip clips. Refer to the following table.

### Available Playback Types

Playback type	Operation
Fast playback	Camcorder: Press the ◀◀ or ▶▶ button. Wireless controller: Press the ◀◀ or ▶▶ button. Repeat to increase the playback speed to approximately 5x → 15x → 60x the normal speed.
Frame advance/reverse	Wireless controller: Press the ◀▶ or ▶▶ button (during playback pause).
Skip to the beginning of the next clip	Camcorder: Press the ▶▶▶ button. Wireless controller: Press the ▶▶▶ button.
Skip to the beginning of the current clip	Camcorder: Press the ◀◀◀ button. Wireless controller: Press the ◀◀◀ button.
Skip to the previous clip	Camcorder: Press the ◀◀◀ button twice. Wireless controller: Press the ◀◀◀ button twice.
Return to playback mode	Camcorder: Press the ▶▶/▶▶ button. Wireless controller: Press the ▶▶/▶▶ button.

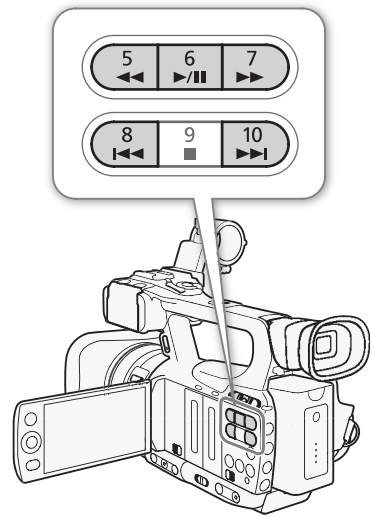

### **i** NOTES

- There is no audio during any of the playback types listed in the previous table.
- During some special playback modes, you may notice some anomalies (blocky video artifacts, banding, etc.) in the playback picture.
- During frame advance, playback advances 0.25 seconds when the resolution/frame rate is 1280x720/50P and 0.5 seconds for other configurations.
- The speed indicated on the screen is approximate.

## Adjusting the Volume

During playback, audio will come from the monaural built-in speaker or headphones. When you connect headphones to the (headphone) terminal, the built-in speaker will be muted.

### Adjusting the Headphone Volume

Follow the procedure below to adjust the headphone volume. Alternatively, you can adjust the volume using the CUSTOM dial ( 46).

- 1 Open the [Headphone Volume] submenu.  
[ ] Audio Setup] > [Audio Output] > [Headphone Volume]
- 2 Select the desired level and then press SET.
  - Select [Off] to mute the audio.

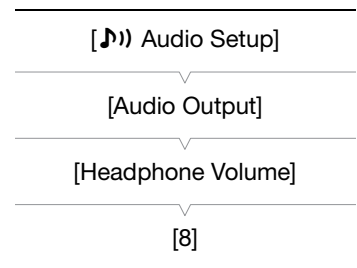

### Adjusting the Built-in Speaker Volume



- 1 Open the [Speaker Volume] submenu.  
     [**J**] Audio Setup] **[>]** [Audio Output] **[>]** [Speaker Volume]
- 2 Select the desired level and then press SET.
  - Select [Off] to mute the audio.

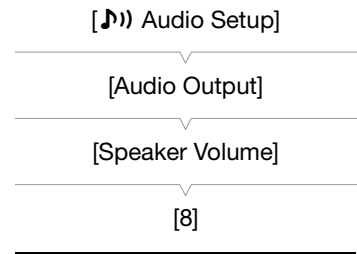

#### NOTES

- For details on changing the audio channel, refer to *Selecting the Audio Channel* ( 126).



### Adding Shot Marks during Playback

You can add an  mark,  mark or both marks to a clip during playback or playback pause. You can add either mark using assignable buttons or an  mark using the wireless controller's SHOT1 button.

- 1 Set an assignable button to [Add Shot Mark 1] or [Add Shot Mark 2] ( 94).
- 2 During playback or playback pause, press the assignable button at the point in the clip to add the shot mark.
  - A message indicating the shot mark appears on the screen and the shot mark is added to the clip.
  - Adding a shot mark to a clip during playback will pause the playback.
  - Up to 100 shot marks ( and  marks combined) can be added to a single clip.
  - There may be up to a 0.5 second delay from when you press the button to when the camcorder adds the shot mark.

## Clip Operations

Besides playing back a clip, you can perform other operations such as deleting a clip or displaying clip information. This is done through the clip menu, which contains different functions depending on the index screen. You can use the functions in the [Other Functions] menu to perform some of the operations on all the clips. Refer to the following table for available functions and refer to the following pages for more details of the functions.

Operating modes: CAMERA MEDIA

### Clip Menu Functions

Menu item	Description	Index screen			📖
		Clip	[OK] Mark/ [✓] Mark	[Shot Mark]¹/ [Expand Clip]	
[Display Clip Info]	Displays various information about a clip.	●	●	–	114
[Add [OK] Mark]/ [Delete [OK] Mark]	Adds or deletes an [OK] mark.	●	●²	–	115
[Add [✓] Mark]/ [Delete [✓] Mark]	Adds or deletes a [✓] mark.	●	●³	–	115
[Copy Clip]	Copies a clip from one CF card to the other.	●	●²	–	116
[Delete Clip]	Deletes a clip.	●	●³	–	117
[Shot Mark]	Displays an index screen of all the frames of a clip that have either shot mark.	●	●	–	118
[Shot Mark 1]	Displays an index screen of all the frames of a clip that have the [S1] mark.	●	●	–	118
[Shot Mark 2]	Displays an index screen of all the frames of a clip that have the [S2] mark.	●	●	–	118
[Expand Clip]	Displays an index screen that shows frames of a clip at a fixed interval.	●	●	–	119
[Delete User Memo]	Deletes the user memo of a clip.	●	●	–	117
[Copy [CP] File]	Copies the custom picture file from a clip to the camcorder.	●	●	–	118
[Add Shot Mark 1]/ [Del. Shot Mark 1]	Adds or deletes the [S1] mark.	–	–	●	119
[Add Shot Mark 2]/ [Del. Shot Mark 2]	Adds or deletes the [S2] mark.	–	–	●	119
[Fewer Index Pics]	Decreases the number of thumbnails that are displayed.	–	–	●⁴	119
[More Index Pics]	Increases the number of thumbnails that are displayed.	–	–	●⁴	119
[Pause]	Switches to playback of a clip with playback paused on the selected frame.	–	–	●	–
[Set Index Picture]	Sets the thumbnail used in the clip index screen.	–	–	●	120

¹ Includes also the [Shot Mark 1] and [Shot Mark 2] index screens.

² [OK] Mark] index screen only.

³ [✓] Mark] index screen only.

⁴ [Expand Clip] index screen only.

## Using the Clip Menu

### 1 Select a clip and then press SET.

- The clip menu appears. Available functions depend on the index screen and which functions are enabled.

### 2 Select the desired function and then press SET.

- The function is enabled. For some functions, further action may be required. Follow the onscreen directions.
- Press the CANCEL button instead to return to the clip index screen.

## Displaying Clip Information

Select [Display Clip Info] in the clip menu to display the selected clip's information screen ([Clip Info] screen). Push the joystick left/right to switch to the previous/next clip. When you are finished, press the CANCEL button to return to the clip index screen.

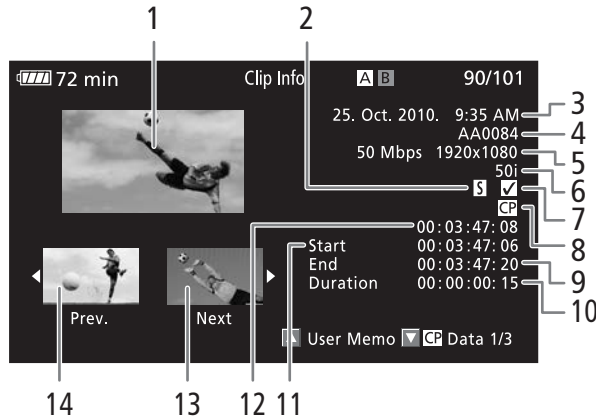

- |   |  |
|---|--|
| 1 Thumbnail of the selected clip  | 7 <input type="checkbox"/> mark / <input checked="" type="checkbox"/> mark (115) |
| 2 Shot mark (83)  | 8 Embedded custom picture file (96)  |
| 3 Recording date and time   | 9 Time code of the last frame in clip  |
| 4 Clip name (41)  | 10 Clip duration   |
| 5 Bit rate and resolution (45)  | 11 Time code of the first frame in clip  |
| 6 Special recording mode / Frame rate (85): For slow & fast motion recording mode, the shooting and playback frame rates will be displayed. | 12 Time code of the clip thumbnail   |
|   | 13 Thumbnail of the next clip  |
|   | 14 Thumbnail of the previous clip  |

## Displaying the User Memo

When displaying the [Clip Info] screen of a clip that has an embedded user memo, push the joystick up to display it. Push the joystick down to return to the [Clip Info] screen.

## Displaying Custom Picture Settings

When displaying the [Clip Info] screen of a clip that has a custom picture file recorded with it, push the joystick down to display the first of three screens with the clip's custom picture settings ([CP Data 1/3] screen). Push the joystick down to switch the [CP Data 2/3] screen → [CP Data 3/3] screen → [User Memo] screen → [Clip Info] screen.

## Adding Marks or Marks

If you add an OK mark () or check mark () to a clip, you can later display an index screen that shows only the clips with an  mark or only the clips with a  mark. Furthermore, you cannot delete clips with an  mark so you can use it to protect important clips.

- 1 Select the desired clip and then press SET to open the clip menu.
- 2 Select [Add  Mark] or [Add  Mark] and then press SET.
  - The clip information screen appears and it prompts you to confirm the operation.
- 3 Select [OK] and then press SET.
  - The screen changes back to the clip index screen and an  mark or  appears next to the selected clip's thumbnail.
  - Select [Cancel] instead to cancel the operation.

### NOTES

- If you set an assignable button to [Add  Mark] or [Add  Mark] (□ 94), you can add an  mark or  mark from the index screen, during playback or during playback pause.
- A clip cannot have both an  mark and  mark at the same time. When you add a  mark to a clip with an  mark, the  mark will be deleted. Similarly, when you add an  mark to a clip with a  mark, the  mark will be deleted.

## Deleting Marks or Marks

### Deleting an Mark or Mark from a Clip

- 1 Select the desired clip and then press SET to open the clip menu.
- 2 Select [Delete  Mark] or [Delete  Mark] and then press SET.
  - The clip information screen appears and it prompts you to confirm the operation.
- 3 Select [OK] and then press SET.
  - The screen changes back to the clip index screen the selected mark is deleted.
  - Select [Cancel] instead to cancel the operation.

### Deleting Marks from All Clips

- 1 Open the [Delete All  Marks] submenu.  
 Other Functions  [Delete All  Marks]
- 2 Select [OK] and then press SET.
  - All  marks from clips on the selected CF card will be deleted.
  - Select [Cancel] instead to cancel the operation.
  - While the  marks are being deleted, you can press SET to cancel.
- 3 When the confirmation message appears, press SET.

---

[ Other Functions]

---

[Delete All  Marks]

---



## Copying Clips

You can copy clips from one CF card to the other. The copied clips will retain their original name.

### 116 Copying a Single Clip



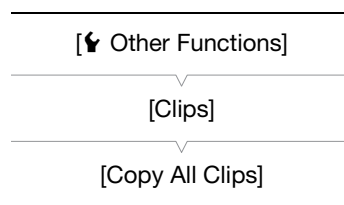

- 1 Select the desired clip and then press SET to open the clip menu.
- 2 Select [Copy Clip] and then press SET.
  - The clip information screen appears and it prompts you to confirm the operation.
- 3 Select [OK] and then press SET.
  - Select [Cancel] instead to cancel the operation.
  - While the clip is being copied, you can press SET to cancel.
- 4 When the confirmation message appears, press SET.
  - The selected clip is copied to the other CF card and the screen changes back to the clip index screen.

### Copying All Clips

- 1 Open the [Copy All Clips] submenu.
  - [Other Functions]  [Clips]  [Copy All Clips]
- 2 Select [OK] and then press SET.
  - All of the clips on the selected CF card will be copied to the other CF card.
  - Select [Cancel] instead to cancel the operation.
  - While the clips are being copied, you can press SET to cancel.
- 3 When the confirmation message appears, press SET.



### Copying All Clips with an Mark

- 1 Open the [Copy  Clips] submenu.
  - [Other Functions]  [Clips]  [Copy  Clips]
- 2 Select [OK] and then press SET.
  - All of the clips with an  mark on the selected CF card will be copied to the other CF card.
  - Select [Cancel] instead to cancel the operation.
  - While the clips are being copied, you can press SET to cancel.
- 3 When the confirmation message appears, press SET.

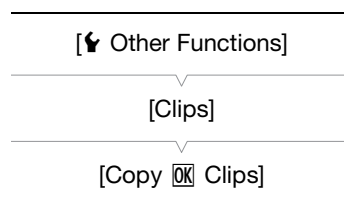

### IMPORTANT

- Observe the following precautions while the CF **A** or CF **B** access indicator is illuminated in red. Failure to do so may result in permanent data loss.
  - Do not disconnect the power source or turn off the camcorder.
  - Do not open the cover of the either CF card slot.

### NOTES

- You cannot copy a clip if either CF card slot cover is open.
- If a clip is being copied to a card that already has a clip with the same number (the 4-digit number in the clip name), then the copied clip will be renamed with the following number.



## Deleting Clips

You can delete any clip except those with an **OK** mark. To delete such clips, delete the **OK** mark beforehand.

### Deleting a Single Clip

- 1 Select the desired clip and then press SET to open the clip menu.
- 2 Select [Delete Clip] and then press SET.
  - The clip information screen appears and it prompts you to confirm the operation.
- 3 Select [OK] and then press SET.
  - Select [Cancel] instead to cancel the operation.
  - While the clip is being deleted, the operation cannot be canceled.
- 4 When the confirmation message appears, press SET.

### Deleting All Clips

- 1 Open the [Delete All Clips] submenu.  
 [👉 Other Functions] ➤ [Clips] ➤ [Delete All Clips]
- 2 Select [OK] and then press SET.
  - All of the clips (except for clips with an **OK** mark) on the selected CF card will be deleted.
  - Select [Cancel] instead to cancel the operation.
  - While the clips are being deleted, you can press SET to cancel.
- 3 When the confirmation message appears, press SET.

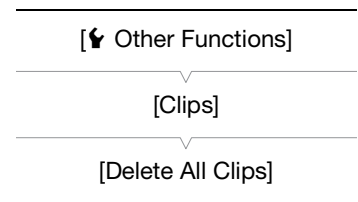

### ! IMPORTANT

- Observe the following precautions while the CF **A** or CF **B** access indicator is illuminated in red. Failure to do so may result in permanent data loss.
  - Do not disconnect the power source or turn off the camcorder.
  - Do not open the cover of the selected CF card slot.

## Deleting the User Memo

- 1 Select the desired clip and then press SET to open the clip menu.
- 2 Select [Delete User Memo] and then press SET.
  - The [Delete User Memo] screen appears and it prompts you to confirm the operation.
- 3 Select [OK] and then press SET.
  - The user memo is deleted and the screen changes back to the clip index screen.
  - Select [Cancel] instead to cancel the operation.

### Copying a Custom Picture File Embedded in a Clip

You can copy the custom picture file embedded in a clip to the camcorder.

- 1 Select the desired clip and then press SET to open the clip menu.
- 2 Select [Copy **CP** File] and then press SET.
  - The [**CP** Data 1/3] screen appears with the orange selection frame indicating the first custom picture file slot in the camcorder.
  - You can push the joystick up/down to display the [**CP** Data 2/3] and [**CP** Data 3/3] screens.
- 3 Push the joystick left/right to select the desired file slot and then press SET.
- 4 Select [OK] and then press SET.
  - The custom picture file already in the selected file slot will be overwritten.
  - Select [Cancel] instead to cancel the operation.
- 5 When the confirmation message appears, press SET.

#### **i** NOTES

- You cannot copy the custom picture file to a file slot with a protected file.
- By default, file slots [C7] to [C9] are protected.

### Displaying an Index Screen of Shot Marks

After you add shot marks to a clip, you can display an index screen that contains all the frames in a clip with either shot mark, only the **S1** mark or only the **S2** mark. When you play back a clip from this index screen, playback will start from the frame indicated by the shot mark. You can also perform other operations from this index screen, such as adding and deleting shot marks.

- 1 Select the desired clip and then press SET to open the clip menu.
- 2 Select [Shot Mark] and then press SET.
  - The [Shot Mark] index screen appears, which contains all the frames with shot marks in the clip. Select instead [Shot Mark 1] to display an index screen only of the frames with the **S1** mark or [Shot Mark 2] to display an index screen only of the frames with the **S2** mark.
  - The time code under the thumbnail indicates the time code of the frame with the shot mark.
  - Press the INDEX button to return to the clip index screen.



#### **i** NOTES

- After you finish playing back a clip from this index screen, the index screen that was open before the [Shot Mark] index screen will appear.

## Displaying a Frame Index Screen of a Single Clip

You can display an index screen of a single clip broken down as frames at fixed intervals. This is useful when you have a long clip or wish to play back a clip from a certain point. You can change how many thumbnails are displayed. You can also perform other operations from this index screen, such as adding and deleting shot marks.

1 Select the desired clip and then press SET to open the clip menu.

2 Select [Expand Clip] and then press SET.

- The [Expand Clip] index screen appears, which shows thumbnails of frames taken from the clip at fixed intervals. The time code under the thumbnail indicates the time code of the frame.
- You can change the fixed interval between frames by showing more or fewer thumbnails. To show more thumbnails, open the clip menu and select [More Index Pics] and then press SET. To show fewer thumbnails, select [Fewer Index Pics] and then press SET.
- Press the INDEX button to return to the clip index screen.

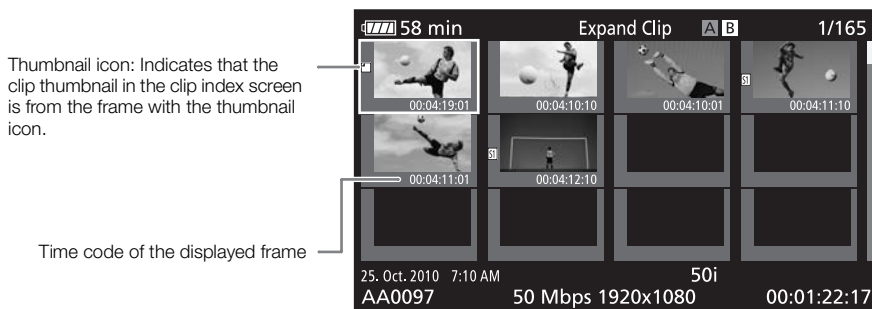

### NOTES

- After you finish playing back a clip from this index screen, the index screen that was open before the [Expand Clip] index screen will appear.

## Adding or Deleting Shot Marks from an Index Screen

From the [Shot Mark] index screen or [Expand Clip] index screen, you can add/delete a shot mark to/from a frame. You can add or delete both shot marks, only the **S1** mark or only the **S2** mark.

### Adding a Shot Mark

1 Open the [Shot Mark] index screen or [Expand Clip] index screen.

2 Select the desired frame (thumbnail) and then press SET to open the clip menu.

3 Select [Add Shot Mark 1] or [Add Shot Mark 2] and then press SET.

- The clip information screen appears and it prompts you to confirm the operation.



4 Select [OK] and then press SET.

- The screen changes back to the previous index screen and the selected shot mark appears next to the selected clip's thumbnail.
- Select [Cancel] instead to cancel the operation.

### Deleting a Shot Mark

- 1 Open the [Shot Mark] index screen or [Expand Clip] index screen.
- 2 Select the desired frame (thumbnail) and then press SET to open the clip menu.
- 3 Select [Del. Shot Mark 1] or [Del. Shot Mark 2] and then press SET.
  - The clip information screen appears and it prompts you to confirm the operation.
- 4 Select [OK] and then press SET.
  - The selected mark is deleted and the screen changes back to the previous index screen.
  - If a frame has no shot marks, it will no longer appear in the [Shot Mark] index screen.
  - Select [Cancel] instead to cancel the operation.

#### NOTES

- If you set an assignable button to [Add Shot Mark 1] or [Add Shot Mark 2] (📖 94), you can add shot marks. You can also add an  mark by using the SHOT1 button on the wireless controller.
- Up to 100 shot marks ( and  marks combined) can be added to a single clip.
- There may be up to a 0.5 second delay from when you press the button to when the camcorder adds the shot mark.

### Changing a Clip's Thumbnail

You can change the thumbnail that appears in the clip index screen to a thumbnail of a frame that appears in the [Shot Mark] index screen or [Expand Clip] index screen.

- 1 Open the [Shot Mark] index screen or [Expand Clip] index screen.
- 2 Select the desired frame (thumbnail) and then press SET to open the clip menu.
- 3 Select [Set Index Picture] and then press SET.
  - The clip information screen appears and it prompts you to confirm the operation.
- 4 Select [OK] and then press SET.
  - The selected frame is set as the thumbnail and the screen changes back to the previous index screen.  appears next to the thumbnail of the selected frame.
  - Select [Cancel] instead to cancel the operation.

#### NOTES

- When playing back a clip from the clip index screen, playback will start from the beginning of the clip, regardless of the thumbnail.

## Video Output Configuration

The video signal output from the HD/SD SDI (**XF105** only), HDMI OUT and HD/SD COMPONENT OUT terminals depends on the clip's video configuration, the capability of the external monitor (for video output from the HDMI OUT terminal) and on various menu settings. Video output from the AV terminal will always be in 576/50i standard.

Operating modes: CAMERA MEDIA

### Video Output Configuration by Terminal

Refer to the following table for the video output configuration from each terminal. If necessary, you can superimpose the onscreen displays on the video displayed on the external monitor (📖 125).

Video Output Configuration by Terminal

Terminal →	HD/SD SDI <sup>1, 2</sup> ( <b>XF105</b> only)		HDMI OUT <sup>2, 3</sup>		HD/SD COMPONENT OUT <sup>2, 4</sup>		AV
	HD output	SD output	HD output	SD output	HD output	SD output	SD output
1080/50i	1080/50i	576/50i <sup>5</sup>	1080/50i	576/50P	1080/50i	576/50i	576/50i
1080/25P							
1080/slow or fast motion							
720/50P	720/50P	576/50i <sup>5</sup>	720/50P	576/50P	720/50P	576/50i	576/50i
720/25P							
720/slow or fast motion							

<sup>1</sup> Set [📺 Video Setup] ⚙ [SDI Output] to [HD], [SD] or [Off].

<sup>2</sup> When you set [📺 LCD/VF Setup] ⚙ [HD Output] (under [Zebra]) to [On], you can display zebra patterns on an external monitor. In such case, output from the HD/SD SDI terminal (**XF105** only) and HD/SD COMPONENT OUT terminal will be in HD, regardless of their setting.

<sup>3</sup> Video output will automatically switch to HD or SD, depending on the capability of the external monitor.

<sup>4</sup> Set [📺 Video Setup] ⚙ [Component Output] to [HD] or [SD].

<sup>5</sup> When output from the HDMI OUT terminal is SD (576/50P), the output of the HD/SD SDI terminal will also be 576/50P.

### NOTES

- **XF105** When the camcorder is connected via HDMI OUT terminal to an external monitor, the video signal output from the HD/SD SDI terminal will be the same as that from the HDMI OUT terminal.

## SD Output

When HD video (16:9 aspect ratio) is converted and output as SD video (4:3 aspect ratio), you can choose how it appears on the external monitor.

1 Open the [SD Output] submenu.

[Video Setup] [SD Output]

2 Select the desired option and then press SET.

### Options

- [Squeeze]: The image is squeezed from the left and right so that the entire image fits within the screen. The image will appear normal if the external monitor also has a 16:9 aspect ratio.
- [Letterbox]: The 16:9 aspect ratio is maintained but black letterbox bars are added to the top and bottom of the image.
- [Side Crop]: The left and right sides of the image are cropped so that the central part of the image fits within the screen.



[Squeeze]  
setting



[Letterbox]  
setting



[Side Crop]  
setting

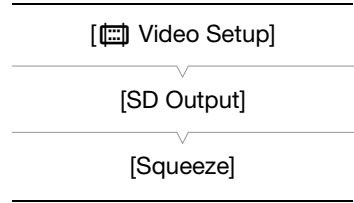

## Connecting to an External Monitor

When you connect the camcorder to an external monitor for recording or playback, use the terminal on camcorder that matches the one you wish to use on the monitor. Then, select the video signal output configuration (📖 121). The camcorder can output video from all of the video output terminals simultaneously.

Operating modes: **CAMERA** **MEDIA**

### Connection Diagram

When you connect the camcorder to an external monitor using the HD/SD COMPONENT OUT terminal, audio is output by connecting the optional STV-250N Stereo Video Cable to the monitor using the AV terminal. We recommend that you power the camcorder from a household power outlet using the compact power adapter.

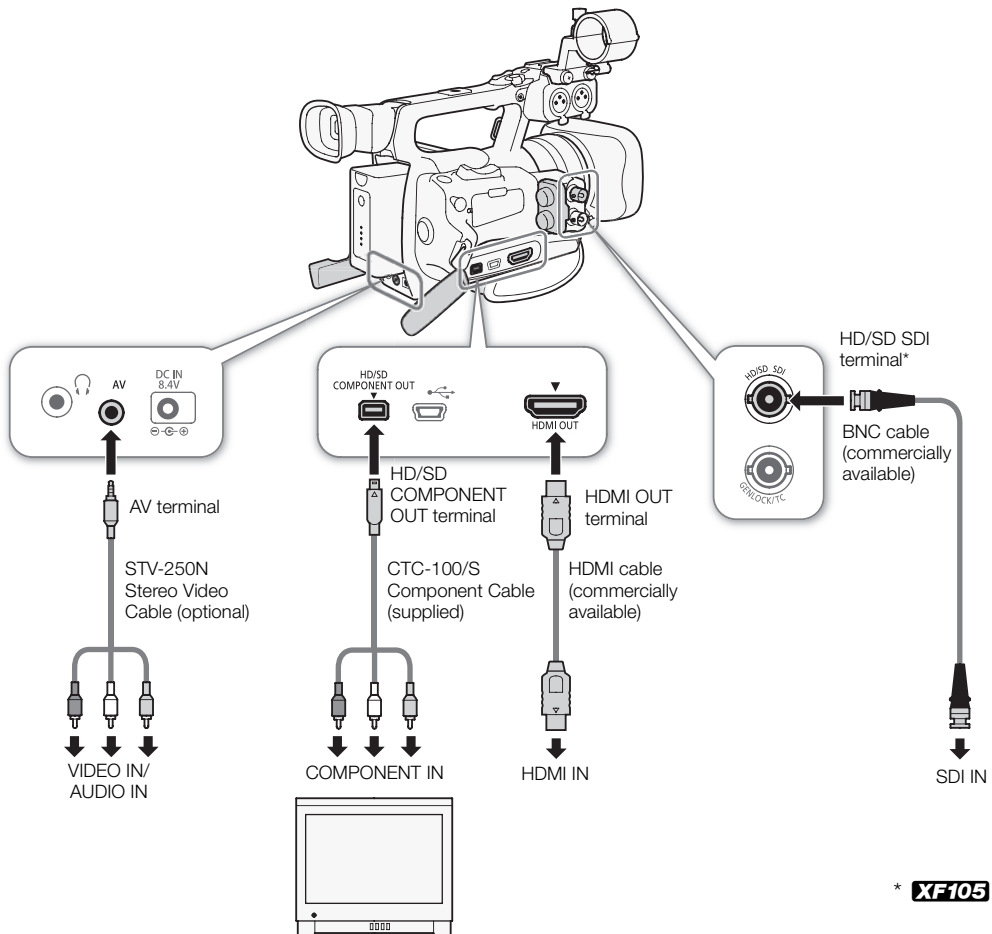

### **XF105** Using the HD/SD SDI Terminal

The digital signal output from the HD/SD SDI terminal includes the video signal, audio signal and time code signal. If necessary, perform the following procedure to change the output to HD or SD. Turning the output off will conserve the camcorder's power.

1 Open the [SDI Output] submenu.

[Video Setup] ● [SDI Output]

2 Select the desired option and then press SET.

- If you selected [HD], no more settings need to be made. If you selected [SD], you can select the SD output method (122).

#### **i** NOTES

- If necessary, you can superimpose the onscreen displays on the video displayed on the external monitor (125).

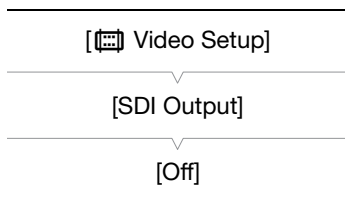

### Using the HDMI OUT Terminal

The HDMI™ OUT terminal also offers a digital connection and outputs both a video and audio signal. The output signal will automatically switch to HD or SD depending on the capability of the external monitor.

#### **i** NOTES

- Correct operation cannot be guaranteed when connecting the camcorder to DVI monitors.
- Video may not be output correctly depending on the monitor. In such case, use another terminal.
- If necessary, you can superimpose the onscreen displays on the video displayed on the external monitor (125).
- You can select the SD output method (122).

### Using the HD/SD COMPONENT OUT Terminal

The HD/SD COMPONENT OUT terminal outputs an analog HD or SD video signal. If necessary, perform the following procedure to change the output to HD or SD.

1 Open the [Component Output] submenu.

[Video Setup] ● [Component Output]

2 Select the desired option and then press SET.

- If you selected [HD], no more settings need to be made. If you selected [SD], you can select the SD output method (122).

#### **i** NOTES

- If necessary, you can superimpose the onscreen displays on the video displayed on the external monitor (125).

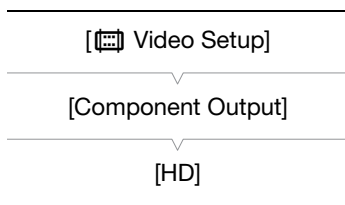



## Using the AV Terminal

When you output video from the AV terminal, the video signal is converted to an analog SD composite video signal. In addition, the AV terminal also outputs audio. You can select the SD output method (📖 122).

### NOTES

- If necessary, you can superimpose the onscreen displays on the video displayed on the external monitor (📖 125).
- When you play back a clip on a monitor with a 4:3 aspect ratio, the monitor will switch automatically to widescreen mode if it is compatible with the WSS system.

## Superimposing Onscreen Displays to Appear on an External Monitor

You can choose to superimpose onscreen displays on the video output from the HD/SD SDI terminal (**XF105** only), HDMI OUT terminal, HD/SD COMPONENT OUT terminal or AV terminal. Doing so will display the onscreen displays on an external monitor. You must set this function separately for HD and SD output. This setting will not affect your recordings.

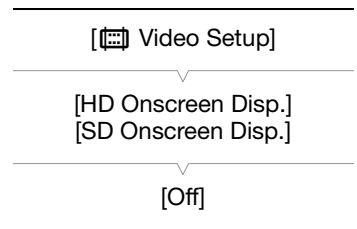

### 1 Open the [HD Onscreen Disp.] or [SD Onscreen Disp.] submenu.

[Video Setup] ➤ [HD Onscreen Disp.] or [SD Onscreen Disp.]



### 2 Select [On] and then press SET.

- **DISP** appears on the right side of the screen (when [ LCD/VF Setup] ➤ [Custom Display 2] ➤ [Output Display] is set to [On]).

### NOTES

- Onscreen displays will not appear on an external monitor for SD output if [Video Setup] ➤ [SD Output] is set to [Side Crop].

## Audio Output

The camcorder can output audio from the HD/SD SDI terminal (**XF105** only), HDMI OUT terminal, AV terminal or  (headphone) terminal. When audio is output from the AV terminal or  (headphone) terminal, you can configure settings such as the output channel. When audio is output from the AV terminal, you can select the output level.

### **XF105** Embedded Audio

Embedded audio refers to the superimposing of the audio signal along with the video signal being output from the HD/SD SDI terminal. If you set the [Video Setup]  [SDI Output] setting to [HD] or [SD], the camcorder will automatically embed audio.



Operating modes: CAMERA MEDIA

### Synchronizing the Video with the Audio being Monitored

When audio is output from the AV terminal or  (headphone) terminal, you can choose to synchronize the audio signal with the video signal or have the camcorder output the audio in real time. When the audio is output in real time, there will be a slight delay. Regardless of the setting, however, the audio and video signals recorded will be synchronized.

Operating modes: CAMERA MEDIA

1 Open the [Monitor Delay] submenu.

[] Audio Setup]  [Audio Output]  [Monitor Delay]

2 Select the desired option and then press SET.

#### Options

[Line Out]: Synchronizes the audio and video signals.

[Normal]: Allows you to monitor the audio in real time.

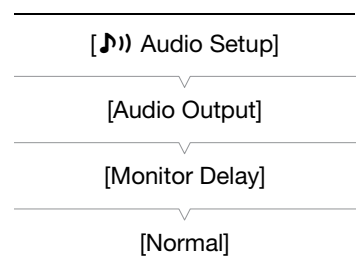

### Selecting the Audio Channel

You can select the audio channel that is output from the AV terminal or  (headphone) terminal.

Operating modes: CAMERA MEDIA

1 Open the [Channel] submenu.

[] Audio Setup]  [Audio Output]  [Channel]

2 Select the desired option and then press SET.

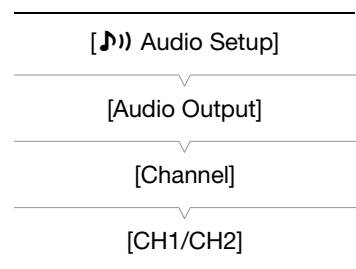

**Options**

- [CH1/CH2]: Audio from CH1 is output from the left audio channel and audio from CH2 is output from the right audio channel.
- [CH1/CH1]: Audio from CH1 is output from both the left and right audio channels.
- [CH2/CH2]: Audio from CH2 is output from both the left and right audio channels.
- [All/All]: Audio from CH1 and CH2 is mixed and output from both the left and right audio channels.

**i** NOTES

- You can change the audio channel by setting an assignable button to [Audio Output CH] (📖 94).

**Selecting the Output Level of the AV Terminal**

You can select the output level of audio that is output from the AV terminal.

Operating modes: CAMERA MEDIA

- Open the audio output [Level] submenu.  
[🔊] Audio Setup ➤ [Audio Output] ➤ [Level]
- Select the desired level and then press SET.

**Options**

- [1 Vrms]: The audio output level is normal.
- [2 Vrms]: The audio output level is 6 dB higher.

**i** NOTES

- This setting does not affect audio output to headphones.

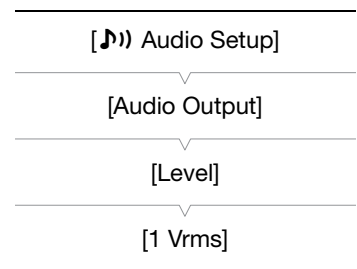

## Saving Clips to a Computer

Use **Canon XF Utility** to save clips or one of the Canon XF plugins\* to import clips into non-linear editing (NLE) software.

\* Plugins are available for NLE software by Avid and Apple.

### Saving MXF Clips

**Canon XF Utility** and the Canon XF plugins are available for free download from your local Canon Web site. Refer to the Web site for the system requirements and the latest information about the software and plugins. For details about using the software, refer to the respective instruction manual (PDF file).

Operating modes:

**Canon XF Utility:** Browser for transferring clips to a computer and playing back, checking and managing clips.

**Plugins for non-linear editing (NLE) software:** The plugins allow you to transfer clips from a computer or a CF card (connected via USB reader to a computer) to the NLE software. The following plugins are available.

- Canon XF Plugin for Avid Media Access (Windows or Mac OS)
- Canon XF Plugin 64 for Avid Media Access (Windows or Mac OS)
- Canon XF Plugin for Final Cut Pro (Mac OS)
- Canon XF Plugin for Final Cut Pro X (Mac OS)

The instruction manual for each module provides more details. Refer to *Viewing the Software Instruction Manuals* (📖 131) for details on accessing the manuals. Refer to Web sites such as your local Canon Web site for the latest information on software.

### Installing Canon XF Utility (Windows)

The following procedures apply to computers running Windows 7. The procedures may be different for other versions. For details see the Help modules of the operating system.

- 1 Double-click the file that you downloaded from the Canon Web site, to decompress it.
  - The file is **xuw-\*\*\*\*\*.zip** (for Canon XF Utility) or **xpmw-\*\*\*\*\*.zip** (for Canon XF Plugin for Avid Media Access and Canon XF Plugin 64 for Avid Media Access).
  - The rest of the explanation refers only to Canon XF Utility but the procedure is similar for the Canon XF plugins.
  - The folder **xuw-\*\*\*\*\*** will be created that contains the file **xuw\*\*\*.exe**.
- 2 Double-click **xuw\*\*\*.exe**.
- 3 Follow the onscreen instructions to select your area (continent), country/region and language.
  - Available options will vary depending on your country/region.
- 4 After the message appears prompting you to exit other applications, exit other applications and then click **OK**.
  - The software's license agreement appears.
- 5 Read the license agreement and click **Yes** to begin the installation.
  - If you do not select **Yes**, you cannot install the software.
  - When the installation has completed, **Installation has completed successfully** appears.

6 Click **Next** and then click **Finish**.

### Uninstalling Canon XF Utility (Windows)

- 1 From the **Start** menu, select **All Programs > Canon Utilities > Canon XF Utility > Uninstall Canon XF Utility**.
  - A confirmation screen appears.
- 2 Click **Yes** to begin uninstalling the software.
  - When the software has been uninstalled, **The software has been successfully uninstalled** appears.
- 3 Click **OK**.

### Uninstalling the Plugins (Windows)

- 1 In the Control Panel, open **Programs and Features** or **Add or Remove Programs**.
  - A list of installed programs appears.
- 2 Select **Canon XF Plugin for Avid Media Access, Canon XF Plugin 64 for Avid Media Access** or **Canon XF MPEG2 Decoder**.
- 3 Click **Uninstall** or **Uninstall/Change**.
- 4 Follow the onscreen instructions.

### Uninstalling the Instructions for Canon XF Plugin for Avid Media Access and Canon XF Plugin 64 for Avid Media Access (Windows)

- 1 From the **Start** menu, open **All Programs > Canon Utilities > Desired plugin > Uninstall Canon XF Plugin for Avid Media Access Instruction Manual** or **Uninstall Canon XF Plugin 64 for Avid Media Access Instruction Manual**.
- 2 When the confirmation screen appears, click **Yes** and then click **OK**.

### Installing Canon XF Utility (Mac OS)

- 1 Double-click the file that you downloaded from the Canon Web site, to decompress it.
  - The downloaded file is **xum-\*\*\*\*\*.dmg.gz** (for Canon XF Utility), **xpmm-\*\*\*\*\*.dmg.gz** (for Canon XF Plugin for Avid Media Access and Canon XF Plugin 64 for Avid Media Access) or **xpfm-\*\*\*\*\*.dmg.gz** (for Canon XF Plugin for Final Cut Pro and Canon XF Plugin for Final Cut Pro X). The rest of the explanation refers only to Canon XF Utility but the procedure is similar for the Canon XF plugins.
  - The file **xum-\*\*\*\*\*.dmg** will be created.
- 2 Double-click **xum-\*\*\*\*\*.dmg**.
  - The **xum\*\*\*** icon will appear on the desktop.
- 3 Double-click **xum\*\*\*** and then double-click **XUMInstaller**.
- 4 Follow the onscreen instructions to select your area (continent), country/region and language.
  - Available options will vary depending on your country/region.
- 5 After the message appears prompting you to exit other applications, exit other applications and then click **OK**.
  - The software's license agreement appears.
- 6 Read the license agreement and click **Yes** to begin the installation.
  - If you do not select **Yes**, you cannot install the software.
  - When the installation has completed, **Installation has completed successfully** appears.
- 7 Click **Next** and then click **Finish**.

### Uninstalling the Software (Mac OS)

Drag and drop the file or folder corresponding to the software that you want to uninstall to **Trash**.

130

Canon XF Utility

/Applications/Canon Utilities/Canon XF Utility

Canon XF Plugin for Final Cut Pro

/Library/Application Support/ProApps/MIO/RAD/Plugins/CanonXF.RADPlug

Canon XF Plugin for Final Cut Pro X

/Library/Application Support/ProApps/MIO/RADPlugins/CanonXF64.RADPlug

Canon XF Plugin for Avid Media Access

/Library/Application Support/Avid/AVX2\_Plug-ins/AMA/MVP\_CanonXF.avx

Canon XF Plugin 64 for Avid Media Access

/Library/Application Support/ProApps/Avid/AVX2\_Plug\_ins/AMA/MVP\_CanonXF64.avx

Canon XF MPEG2 Decoder

/Library/QuickTime/XFMpeg2Dec.component

Instructions for the plugins

/Applications/Canon Utilities/<desired plugin>

- For <desired plugin>, select Canon XF Plugin for Avid Media Access, Canon XF Plugin 64 for Avid Media Access, Canon XF Plugin for Final Cut Pro or Canon XF Plugin for Final Cut Pro X.

## Viewing the Software Instruction Manuals

For details on using the software, refer to the instruction manual (PDF file) of each module. The instruction manuals are installed with the software. The following procedures for computers running Windows apply to Windows 7. The procedures may be different for other versions. For details see the Help modules of the operating system.

### Viewing the Canon XF Utility Instruction Manual

#### Windows:

- 1 From the **Start** menu, select **All Programs > Canon Utilities > Canon XF Utility > Canon XF Utility Instruction Manual**.
- 2 Select the language of the instruction manual to view.

#### Mac OS:

- 1 From **Applications**, open **Canon Utilities > Canon XF Utility > Manual**.
- 2 Open the folder of the language and double-click the PDF file.

You can also view the instruction manual by starting the **Canon XF Utility** software and then selecting **Help > View Instruction Manual**.

### Viewing the Plugin Instructions

Instructions for Canon XF Plugin for Avid Media Access and Canon XF Plugin 64 for Avid Media Access (Windows):

- 1 From the **Start** menu, select **All Programs > Canon Utilities > Desired plugin > Canon XF Plugin for Avid Media Access Instruction Manual** or **Canon XF Plugin 64 for Avid Media Access Instruction Manual**.
- 2 Select the desired language.

Instructions for Canon XF Plugin for Final Cut Pro and Canon XF Plugin for Final Cut Pro X (Mac OS):

- 1 From **Applications**, open **Canon Utilities > Desired plugin > Manual**.
- 2 Open the folder of the language and double-click the PDF file.

Instructions for Canon XF Plugin for Avid Media Access and Canon XF Plugin 64 for Avid Media Access (Mac OS):

- 1 From **Applications**, open **Canon Utilities > Desired plugin > Manual**.
- 2 Open the folder of the language and double-click the PDF file.

## Taking Photos

You can take photos when the camcorder is in **CAMERA** mode or you can capture a photo from a clip when the camcorder is in **MEDIA** mode. Photos are saved onto the SD card. In **CAMERA** mode, photo size is 1920x1080\*. In **MEDIA** mode, photo size depends on the resolution setting of the clip that the photo is captured from. If the clip is 1920x1080 or 1440x1080, the photo size is 1920x1080. If the clip is 1280x720, the photo size is 1280x720.

\* At this size, the camcorder can save approximately 670 photos on a 1 GB SD card.

### Taking Photos in CAMERA Mode

You can take a photo while the camcorder is recording a clip or is in record pause mode. If a custom picture file is selected in advance, it will be recorded with the photo (📖 96). To take a photo, set an assignable button to [Photo] first or use the wireless controller.

Operating modes: **CAMERA** **MEDIA**

#### 1 Set an assignable button to [Photo] (📖 94).

- This step is not necessary if you are using the wireless controller.

#### 2 Press the assignable button to take a photo.

- Alternatively, press the PHOTO button on the wireless controller.
- The 📷 icon and the number of available photos appear on the upper right portion of the screen.
- If a custom picture file is selected, it will be recorded with the photo.
- The SD card access indicator will flash as the photo is being recorded.

### Capturing Photos in MEDIA Mode

You can capture a photo from a clip during playback pause. To capture a photo, set an assignable button to [Photo] first or use the wireless controller.

Operating modes: **CAMERA** **MEDIA**

#### 1 Set an assignable button to [Photo] (📖 94).

- This step is not necessary if you are using the wireless controller.

#### 2 Select the desired clip and press the ▶/⏸ button to start playback.

#### 3 Pause the playback at the point you want to capture.

#### 4 Press the assignable button to capture a photo.

- Alternatively, press the PHOTO button on the wireless controller.
- The screen will momentarily turn black as if a camera shutter had released.
- The 📷 icon and the number of available photos appear on the upper right portion of the screen.
- The SD card access indicator will flash as the photo is being recorded.

#### 5 Press the ■ button to stop playback.



**!** IMPORTANT

- Observe the following precautions while the SD card access indicator is flashing. Failure to do so may result in permanent data loss.
  - Do not disconnect the power source or turn off the camcorder.
  - Do not remove the SD card.

**i** NOTES

- If the LOCK switch on the SD card is set to prevent writing, you will not be able to record a photo. Change the position of the LOCK switch in advance.
- Photos will not be inverted regardless of the [**!** Other Functions] **!** [Custom Function] **!** [Scan Reverse Rec] setting.

## Photo Playback

You can view the photos that you took with the camcorder.

134 Operating modes: **CAMERA** **MEDIA**

### Displaying the [Photos] Index Screen

Display the [Photos] index screen to view photos.

- 1 Hold down the button on the **POWER** switch and move it to **MEDIA**.
  - The camcorder switches to **MEDIA** mode and the clip index screen appears.
- 2 Press the **INDEX** button.
  - The index screen selection menu appears.
- 3 Select **[Photo Index]** and then press **SET**.
  - The [Photos] index screen appears.
  - After you are finished viewing photos, press the **INDEX** button to return to the clip index screen.

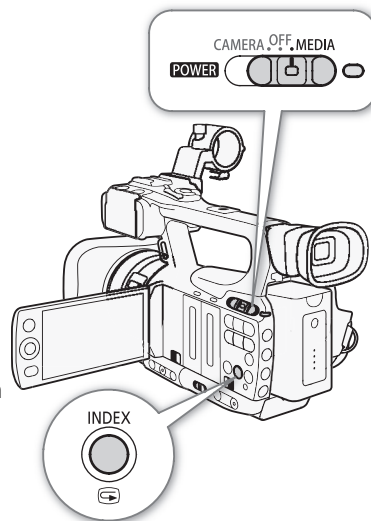

### Viewing Photos

- 1 Move the orange selection frame to the desired photo.
- 2 Press the **▶/||** button to view the photo.
  - The photo playback screen appears and the selected photo is displayed.
  - Use the **◀◀/▶▶** buttons to switch to the previous/next photo.
  - Press the **DISP.** button to hide/show the onscreen displays.
  - Press the **■** button to return to the [Photos] index screen.

#### ! IMPORTANT

- Observe the following precautions while the SD card access indicator is flashing. Failure to do so may result in permanent data loss.
  - Do not disconnect the power source or turn off the camcorder.
  - Do not remove the SD card.
- The following photos may not be displayed correctly.
  - Photos not recorded with this camcorder.
  - Photos created or edited on a computer.
  - Photos whose file names have been changed.

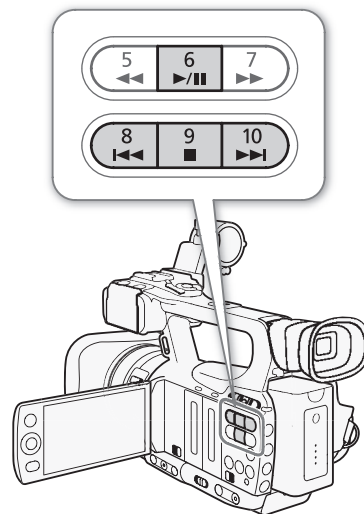

## Photo Operations

You can use the photo menu to protect or unprotect a photo, delete a photo, or copy a custom picture file embedded in a photo. You can display the photo menu from the [Photos] index screen or photo playback screen.

### Using the Photo Menu

1 From the [Photos] index screen, select a photo and then press SET.

- If you are viewing a photo, simply press SET.
- The photo menu appears. Available functions depend on the photo's settings.

2 Select the desired function and then press SET.

### Deleting Photos

You can delete a photo you no longer need. When you do so, however, the custom picture file embedded in it will also be deleted. Photos can be deleted one at a time from the photo playback screen or [Photos] index screen.

Operating modes:

#### Deleting a Photo from the Playback Screen

- 1 Display the photo to be deleted (📖 134).
- 2 Press SET to open the photo menu.
- 3 Select [Delete] and then press SET.
  - The screen prompts you to confirm the operation.
- 4 Select [OK] and then press SET.
  - Select [Cancel] instead to cancel the operation.
  - The selected photo is deleted and the next photo is displayed.
  - If a custom picture file is embedded in the photo, it is also deleted.
- 5 When the confirmation message appears, press SET.

#### Deleting a Photo from the Index Screen

- 1 Open the [Photos] index screen (📖 134).
- 2 Move the orange selection frame to the photo to be deleted.
- 3 Press SET to open the photo menu.
- 4 Select [Delete] and then press SET.
  - The screen prompts you to confirm the operation.
- 5 Select [OK] and then press SET.
  - Select [Cancel] instead to cancel the operation.
  - The selected photo is deleted.
  - If a custom picture file is embedded in the photo, it is also deleted.
- 6 When the confirmation message appears, press SET.

## Deleting All Photos

1 Open the [Delete All Photos] submenu.

[👉 Other Functions] ➤ [Delete All Photos]

2 Select [OK] and then press SET.

- All of the photos on the SD card will be deleted.
- Select [Cancel] instead to cancel the operation.
- While the photos are being deleted, you can press SET to cancel.

3 When the confirmation message appears, press SET.

### ! IMPORTANT

- Be careful when deleting photos. Deleted photos cannot be recovered.

### i NOTES

- Protected photos cannot be deleted.

## Protecting Photos

You can protect photos to prevent accidental erasure. The custom picture file embedded in such a photo is also protected. Photos can be protected from the photo playback screen or [Photos] index screen.

Operating modes: CAMERA MEDIA

### Protecting a Photo from the Playback Screen

1 Display the photo to be protected.

- Refer to *Viewing Photos* (📖 134).

2 Press SET to open the photo menu.

3 Select [Protect] and then press SET.

- To remove protection settings from a protected photo, select [Unprotect] instead.
- The screen prompts you to confirm the operation.

4 Select [OK] and then press SET.

- Select [Cancel] instead to cancel the operation.
- The selected photo is protected and  appears on the bottom left portion of the screen.
- If a custom picture file is embedded in the photo, it is also protected.

### Protecting a Photo from the Index Screen

1 Open the [Photos] Index Screen

- Refer to *Viewing Photos* (📖 134).

2 Move the orange selection frame to the photo to be protected.

3 Press SET to open the photo menu.

4 Select [Protect] and then press SET.

- To remove protection settings from a protected photo, select [Unprotect] instead.
- The screen prompts you to confirm the operation.

---

[👉 Other Functions]

---

[Delete All Photos]

---

5 Select [OK] and then press SET.

- The selected photo is protected and  appears next to the photo's thumbnail.
- Select [Cancel] instead to cancel the operation.
- If a custom picture file is embedded in the photo, it is also protected.

### IMPORTANT





- Initializing an SD card will permanently erase all the data it contains, including protected photos and custom picture files.

## Copying Custom Picture Files





You can copy to the camcorder a custom picture file embedded in a photo. Custom picture files can be copied from the photo playback screen or [Photos] index screen.

Operating modes:  

### Copying a File from the Playback Screen

- 1 Display the photo with the custom picture file to be copied.
  - Refer to *Viewing Photos* ( 134).
- 2 Press SET to open the photo menu.
- 3 Select [Copy  File] and then press SET.
  - The [ Data 1/3] screen appears with the orange selection frame indicating the first file slot in the camcorder.
  - You can push the joystick up/down to display the [ Data 2/3] and [ Data 3/3] screens.
- 4 Select the desired file slot in the camcorder and then press SET.
- 5 Select [OK] and then press SET.
  - The custom picture file embedded in the selected photo is copied, overwriting the file in that slot.
- 6 When the confirmation message appears, press SET.

### Copying a File from the Index Screen

- 1 Open the [Photos] Index Screen.
  - Refer to *Viewing Photos* ( 134).
- 2 Move the orange selection frame to the photo with the custom picture file to be copied.
- 3 Press SET to open the photo menu.
- 4 Select [Copy  File] and then press SET.
  - The [ Data 1/3] screen appears with the orange selection frame indicating the first file slot in the camcorder.
  - You can push the joystick up/down to display the [ Data 2/3] and [ Data 3/3] screens.
- 5 Select the desired file slot in the camcorder and then press SET.
- 6 Select [OK] and then press SET.
  - The custom picture file embedded in the selected photo is copied, overwriting the file in that slot.
- 7 When the confirmation message appears, press SET.

### NOTES

- You cannot copy a custom picture file to a slot that is protected.

## Photo Numbering

Photos are automatically assigned consecutive numbers from 0101 to 9900, and stored on the SD card in folders containing up to 100 photos. Folders are numbered from 101 to 998. You can select the photo numbering method to be used.

The photo number indicates the name and location of the file on the SD card. For example, a photo numbered 101-0107 is located in the "DCIM\101CANON" folder as the file "IMG\_0107.jpg".

Operating modes: CAMERA MEDIA

1 Open the [Photo Numbering] submenu.

[👉 Other Functions] ➤ [Photo Numbering]

2 Select the desired option and the press SET.

### Options

[Reset]: Photo numbers will restart from 101-0101 every time you insert a new SD card. If an SD card already contains photos, photo numbers will continue from the number following that of the last photo on the SD card.

[Continu.]: Photo numbers will continue from the number following that of the last photo recorded with the camcorder.

### NOTES

- If you select [Continu.] and the SD card you insert already contains a photo with a larger number, a new photo will be assigned a number one higher than that of the last photo on the SD card.
- We recommend using the [Continu.] setting.

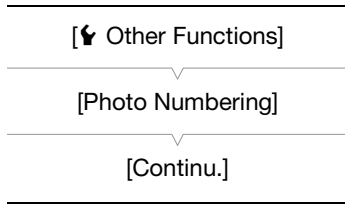

## Menu Options

For details about how to select an item, refer to *Using the Menus* (📖 27). For details about each function, see the reference page. Menu items without a reference page are explained after the tables. Setting options in boldface indicate default values. Menu items not available appear grayed out.

To skip directly to the page of a specific menu:

[📷 Camera Setup] menu	📖 139
Custom picture [🖨️ Edit File] settings	📖 140
[🎵 Audio Setup] menu	📖 142
[📺 Video Setup] menu	📖 142
[📺 LCD/VF Setup] menu	📖 143
[00:00 TC/UB Setup] menu	📖 146
[👉 Other Functions] menu	📖 146

[📷 Camera Setup] menu (CAMERA mode only)

Menu item	Submenu	Setting options	📖
[Light Metering]		[Backlight], <b>[Standard]</b> , [Spotlight]	58
[AE Shift]		[+2.0], [+1.5], [+1.25], [+1.0], [+0.75], [+0.5], [+0.25], <b>[±0]</b> , [-0.25], [-0.5], [-0.75], [-1.0], [-1.25], [-1.5], [-2.0]	58
[AGC Limit]		<b>[Off/24 dB]</b> , [21 dB], [18 dB], [15 dB], [12 dB], [9 dB], [6 dB], [3 dB]	53
[Gain]	[L]	[Fine Tuning], [33.0 dB], [24.0 dB], [18.0 dB], [12.0 dB], [6.0 dB], [3.0 dB], <b>[0.0 dB]</b> , [-3.0 dB], [-6.0 dB]	53
	[M]	[Fine Tuning], [33.0 dB], [24.0 dB], [18.0 dB], [12.0 dB], <b>[6.0 dB]</b> , [3.0 dB], [0.0 dB], [-3.0 dB], [-6.0 dB]	
	[H]	[Fine Tuning], [33.0 dB], [24.0 dB], [18.0 dB], <b>[12.0 dB]</b> , [6.0 dB], [3.0 dB], [0.0 dB], [-3.0 dB], [-6.0 dB]	
[Shutter]		<b>[Automatic]</b> , [Speed], [Angle], [Clear Scan], [Slow]	55
[ND Filter]		<b>[Automatic]</b> , [Off]	–
[White Balance]		<b>[Daylight]</b> , [Tungsten], [Kelvin]	59
[AF Mode]	[Speed]	<b>[Instant]</b> , [Medium], [Normal]	49
	[Face AF]	[Face Pri.], [Face Only], <b>[Off]</b>	50
[Focus Limit]		[On], <b>[Off]</b>	51
[OIS Functions]		[Axis Shift], <b>[Img Stab.]</b> , [Off]	52, 92
[Axis Shift]	[Reset]	[Cancel], [OK]	92
	[Adjust]	–	
	[GUI Color]	<b>[Yellow]</b> , [Green]	
[Image Stabilizer]		[Dynamic], <b>[Standard]</b>	52
[Zoom]	[Speed Level]	[Fast], <b>[Normal]</b> , [Slow]	63
	[Soft Zoom Control]	[Both], [Stop], [Start], <b>[Off]</b>	–
	[Grip Rocker]	[Constant], <b>[Variable]</b>	63
	[Constant Speed]	1-16 ( <b>8</b> )	
	[Handle Rocker]	[Off], 1 - 16 ( <b>8</b> )	64
	[Wireless Controller]	1-16 ( <b>8</b> )	65
	[Focal Length Guide]	[Set To 0], <b>[Off]</b>	93

Menu item	Submenu	Setting options	
[Tele-converter]		[6.0x], [3.0x], [1.5x], <b>[Off]</b>	–
[Flicker Reduction]		[Automatic], <b>[Off]</b>	56
[Conversion Lens]		[TL-H58], [WD-H58W], <b>[Off]</b>	–
[Color Bars]	[Enable]	[On], <b>[Off]</b>	80
	[Type]	<b>[Type 1]</b> , [Type 2]	
[Infrared]	[Monochrome]	<b>[White]</b> , [Green]	90
	[Light]	<b>[Toggle]</b> , [Always On], [Always Off]	90
	[Slow Shutter]	[On], <b>[Off]</b>	–
[Custom Picture]	[ <b>CP</b> Select File]	Custom picture files in the camcorder and SD card.	96
	[ <b>CP</b> Edit File]	Refer to the following table for setting options and default values.	97
	[ <b>CP</b> Transfer File]	For custom picture files in the camcorder: [Copy To ], [Load From ] For custom picture files on the SD card: [Copy To Cam.], [Load From Cam.]	98

[ND Filter]: Allows the camcorder to control the ND filter automatically. When the ND filter is activated, the icon of one of three available settings - 1/2 (ND ) , 1/4 (ND ) and 1/8 (ND ) -will appear on the screen.

[Soft Zoom Control]: When this setting is activated, the zoom will start and/or stop gradually.

[Both]: Affects both when you start and when you stop zooming.

[Stop]: Affects only when you stop zooming.

[Start]: Affects only when you start zooming.

[Tele-converter]: Determines the operation of the digital tele-converter. When activated, the focal length of the camcorder increases by a factor of approximately 1.5, 3 or 6, depending on the setting.

- The image is digitally processed, so the image resolution may deteriorate.

[Slow Shutter]: Activates the slow shutter for Infrared mode.

Custom picture [**CP** Edit File] settings

Menu item	Submenu	Setting options		
[Rename]			97	
[Protect]		<b>[Unprotect]</b> , [Protect]	97	
[Reset]		<b>[Cancel]</b> , [OK]	97	
[Gamma]		<b>[Normal 1]</b> , [Normal 2], [Normal 3], [Normal 4], [Cine 1], [Cine 2]	99	
[Black]	[Master Pedestal]	-50 to 50 <b>(0)</b>	99	
	[Master Black]	[Red]		-50 to 50 <b>(0)</b>
		[Green]		-50 to 50 <b>(0)</b>
		[Blue]		-50 to 50 <b>(0)</b>
[Black Gamma]	[Level]	-50 to 50 <b>(0)</b>	100	
	[Range]	-5 to 50 <b>(0)</b>		
	[Point]	-1 to 50 <b>(0)</b>		
[Low Key Satur.]	[Enable]	<b>[Off]</b> , [On]	100	
	[Level]	-50 to 50 <b>(0)</b>		



Menu item	Submenu	Setting options		
[Knee]	[Enable]	[Off], <b>[On]</b>	100	
	[Automatic]	[Off], <b>[On]</b>		
	[Slope]	-35 to 50 <b>(0)</b>		
	[Point]	50 to 109 <b>(95)</b>		
	[Saturation]	-10 to 10 <b>(0)</b>		
[Sharpness]	[Level]	-10 to 50 <b>(0)</b>	101	
	[H Detail Freq.]	-8 to 8 <b>(0)</b>		
	[Coring]	[Level]		-30 to 50 <b>(0)</b>
		[D-Ofst]		0 to 50 <b>(0)</b>
		[D-Curve]		0 to 8 <b>(0)</b>
		[D-Depth]		-4 to 4 <b>(0)</b>
	[HV Detail Bal.]	-8 to 8 <b>(0)</b>		
	[Limit]	-50 to 50 <b>(0)</b>		
	[Knee Aperture]	[Gain]		0 to 9 <b>(0)</b>
		[Slope]		0 to 3 <b>(1)</b>
	[Level Depend]	[Level]		0 to 50 <b>(0)</b>
		[Slope]		0 to 3 <b>(0)</b>
		[Offset]		0 to 50 <b>(0)</b>
[Ingredient Ratio]	-50 to 50 <b>(0)</b>			
[Noise Reduction]		<b>[Automatic]</b> , [Off], 1 to 8	101	
[Skin Detail]	[Effect Level]	<b>[Off]</b> , [Low], [Middle], [High]	101	
	[Hue]	-16 to 16 <b>(0)</b>		
	[Chroma]	0 to 31 <b>(16)</b>		
	[Area]	0 to 31 <b>(16)</b>		
	[Y Level]	0 to 31 <b>(16)</b>		
[Selective NR]	[Effect Level]	<b>[Off]</b> , [Low], [Middle], [High]	102	
	[Hue]	-16 to 16 <b>(0)</b>		
	[Chroma]	0 to 31 <b>(16)</b>		
	[Area]	0 to 31 <b>(16)</b>		
	[Y Level]	0 to 31 <b>(16)</b>		
[Color Matrix]	[Select]	<b>[Normal 1]</b> , [Normal 2], [Normal 3], [Normal 4], [Cine 1], [Cine 2]	102	
	[Gain]	-50 to 50 <b>(0)</b>		
	[Phase]	-18 to 18 <b>(0)</b>		
	[R-G]	-50 to 50 <b>(0)</b>		
	[R-B]	-50 to 50 <b>(0)</b>		
	[G-R]	-50 to 50 <b>(0)</b>		
	[G-B]	-50 to 50 <b>(0)</b>		
	[B-R]	-50 to 50 <b>(0)</b>		
[B-G]	-50 to 50 <b>(0)</b>			
[White Balance]	[R Gain]	-50 to 50 <b>(0)</b>	102	
	[G Gain]	-50 to 50 <b>(0)</b>		
	[B Gain]	-50 to 50 <b>(0)</b>		

Menu item	Submenu		Setting options	
[Color Correction]	[Select Area]		[Off], [Area A], [Area B], [Area A&B]	103
	[Area A Setting]	[Phase]	0 to 31 <b>(0)</b>	
		[Chroma]	0 to 31 <b>(16)</b>	
		[Area]	0 to 31 <b>(16)</b>	
		[Y Level]	0 to 31 <b>(16)</b>	
	[Area A Revision]	[Level]	-50 to 50 <b>(0)</b>	
		[Phase]	-18 to 18 <b>(0)</b>	
	[Area B Setting]	[Phase]	0 to 31 <b>(0)</b>	
		[Chroma]	0 to 31 <b>(16)</b>	
		[Area]	0 to 31 <b>(16)</b>	
[Y Level]		0 to 31 <b>(16)</b>		
[Area B Revision]	[Level]	-50 to 50 <b>(0)</b>		
	[Phase]	-18 to 18 <b>(0)</b>		
[Other Functions]	[Setup Level]	[Level]	-50 to 50 <b>(0)</b>	103
		[Press]	[Off], [On]	
	[Clip At 100%]	[Off], [On]		

[🔊] Audio Setup] menu

Menu item	Submenu	Setting options	CAMERA	MEDIA	
[Audio Input]	[XLR Rec Channel]	[CH1], [CH1/CH2]	●	–	76
	[Int. Mic Low Cut]	[Off], [LC1], [LC2]	●	–	74
	[Int. Mic Sensitivity]	[Normal], [High]	●	–	74
	[Int. Mic Att.]	[On], [Off]	●	–	75
	[XLR1 Mic Trimming]	[+12 dB], [+6 dB], [0 dB],	●	–	76
	[XLR2 Mic Trimming]	[-6 dB], [-12 dB]			
	[XLR1 Mic Att.]	[On], [Off]	●	–	77
	[XLR2 Mic Att.]				
	[XLR ALC Link]	[Linked], [Separated]	●	–	77
	[Limiter]	[On], [Off]	●	–	78
	[1 kHz Tone]	[-12 dB], [-18 dB], [-20 dB], [Off]	●	–	80
[Audio Output]	[Monitor Delay]	[Line Out], [Normal]	●	–	78
	[Channel]	[CH1/CH2], [CH1/CH1], [CH2/CH2], [All/All]	●	●*	126
	[Level]	1 Vrms, 2 Vrms	●	●*	127
	[Headphone Volume]	[Off], 1-15 <b>(8)</b>	●	●*	111
	[Speaker Volume]	[Off], 1-15 <b>(8)</b>	–	●*	112

\* Not available in the [Photos] index screen.

[📺] Video Setup] menu

Menu item	Setting options	
[SDI Output] ( <b>XF105</b> only)	[HD], [SD], [Off]	124
[Component Output]	[HD], [SD]	124
[HD Onscreen Disp.]	[On], [Off]	125
[SD Onscreen Disp.]	[On], [Off]	
[SD Output]	[Squeeze], [Letterbox], [Side Crop]	122

[ LCD/VF Setup] menu

Menu item	Submenu	Setting options	CAMERA	MEDIA	
[LCD Setup]	[Brightness]	-99 to 99 <b>(0)</b>	●	●	30
	[Contrast]	-99 to 99 <b>(0)</b>	●	●	
	[Color]	-20 to 20 <b>(0)</b>	●	●	
	[Sharpness]	1 to 4 <b>(2)</b>	●	●	
	[Backlight]	<b>[Normal]</b> , [Bright]	●	●	
[VF Setup]	[Brightness]	-99 to 99 <b>(0)</b>	●	●	30
	[Contrast]	-99 to 99 <b>(0)</b>	●	●	
	[Color]	-3 to 3 <b>(0)</b>	●	●	
	[Backlight]	<b>[Normal]</b> , [Bright]	●	●	
[LCD/VF B&W]		[On], <b>[Off]</b>	●	●	31
[LCD/VF Simul.]		[On], <b>[Off]</b>	●	●	30
[Metadata Display]	[Date/Time]	[On], <b>[Off]</b>	–	●*	–
	[Camera Data]	[On], <b>[Off]</b>	–	●	
[Peaking]		[On], <b>[Off]</b>	●	–	48
[Select]		<b>[Peaking 1]</b> , [Peaking 2]	●	–	
[Peaking 1]	[Color]	<b>[White]</b> , [Red], [Yellow], [Blue]	●	–	
	[Gain]	[Off], 1-15 <b>(8)</b>	●	–	
	[Frequency]	1 to 4 <b>(2)</b>	●	–	
[Peaking 2]	[Color]	[White], <b>[Red]</b> , [Yellow], [Blue]	●	–	
	[Gain]	[Off], 1-15 <b>(15)</b>	●	–	
	[Frequency]	1 to 4 <b>(1)</b>	●	–	
[Zebra]		[On], <b>[Off]</b>	●	–	67
[Select]		<b>[Zebra 1]</b> , [Zebra 2], [Zebra 1&2]	●	–	
[Zebra 1 Level]		<b>[70 ±5%]</b> , [75 ±5%], [80 ±5%], [85 ±5%], [90 ±5%], [95 ±5%]	●	–	
[Zebra 2 Level]		[70%], [75%], [80%], [85%], [90%], [95%], <b>[100%]</b>	●	–	
[HD Output]		[On], <b>[Off]</b>	●	–	
[Markers]	[Enable]	[On], <b>[Off]</b>	●	–	67
	[Center]	[White], [Gray], <b>[Off]</b>	●	–	
	[Horizontal]	[White], [Gray], <b>[Off]</b>	●	–	
	[Grid]	[White], [Gray], <b>[Off]</b>	●	–	
	[Safety Zone]	[White], [Gray], <b>[Off]</b>	●	–	
	[Safety Zone Area]	[80%], [90%], [92.5%], <b>[95%]</b>	●	–	
	[Aspect Marker]	[White], [Gray], <b>[Off]</b>	●	–	
[Aspect Ratio]	[4:3], [13:9], [14:9], [1.66:1], [1.75:1], [1.85:1], <b>[2.35:1]</b>	●	–		
[Audio Level]		<b>[On]</b> , [Off]	●	–	–

Menu item	Submenu	Setting options	CAMERA	MEDIA	
[Custom Display 1]	[Zoom Position]	[Always On], <b>[Normal]</b> , [Off]	●	–	–
	[Light Metering]	<b>[On]</b> , [Off]	●	–	
	[Custom Picture]	<b>[On]</b> , [Off]	●	–	
	[ND Filter]	<b>[On]</b> , [Off]	●	–	
	[Focus Mode]	<b>[On]</b> , [Off]	●	–	
	[Object Distance]	[Always On], <b>[Normal]</b> , [Off]	●	–	
	[Full Auto/Lock]	<b>[On]</b> , [Off]	●	–	
	[Infrared]	<b>[On]</b> , [Off]	●	–	
	[White Balance]	<b>[On]</b> , [Off]	●	–	
	[Exposure]	<b>[On]</b> , [Off]	●	–	
	[Iris]	<b>[On]</b> , [Off]	●	–	
	[Gain]	<b>[On]</b> , [Off]	●	–	
	[Shutter]	<b>[On]</b> , [Off]	●	–	
	[Conversion Lens]	<b>[On]</b> , [Off]	●	–	
	[Tele-converter]	<b>[On]</b> , [Off]	●	–	
	[Peaking]	<b>[On]</b> , [Off]	●	–	
	[Magnification]	<b>[On]</b> , [Off]	●	–	
[OIS Functions]	<b>[On]</b> , [Off]	●	–		
[Custom Display 2]	[Remaining Battery]	[Warning], <b>[Normal]</b> , [Off]	●	–	–
	[Remaining Rec Time]	[Warning], <b>[Normal]</b> , [Off]	●	–	
	[Rec Mode]	<b>[On]</b> , [Off]	●	–	
	[Genlock]	<b>[On]</b> , [Off]	●	–	
	[Time Code]	<b>[On]</b> , [Off]	●	–	
	[Interval Counter]	<b>[On]</b> , [Off]	●	–	
	[SD Card Status]	[Warning], <b>[Normal]</b> , [Off]	●	–	
	[Bit Rate/Resolution]	<b>[On]</b> , [Off]	●	–	
	[Frame Rate]	<b>[On]</b> , [Off]	●	–	
	[Character Rec]	<b>[On]</b> , [Off]	●	–	
	[Wireless Controller]	<b>[On]</b> , [Off]	●	–	
	[Output Display]	[On], <b>[Off]</b>	●	–	
	[SDI Rec Command]	<b>[On]</b> , [Off]	●	–	
	[User Memo]	<b>[On]</b> , [Off]	●	–	
	[User Bit]	<b>[On]</b> , [Off]	●	–	
	[Audio Output CH]	<b>[On]</b> , [Off]	●	–	
	[Date/Time]	[Date/Time], [Time], [Date], <b>[Off]</b>	●	–	

\* Not available in the [Photos] index screen.

[Metadata Display]: Displays the date and time of recording and/or the camera data (shutter speed, aperture value, gain) during playback.



[Audio Level]: Displays the audio level meter when set to [On].

### [Custom Display 1] settings



[Zoom Position]: Controls when the zoom indicator appears.

[Always On]: Always appears on the screen.

[Normal]: Appears only when operating the zoom.

[Light Metering]: When set to [On], the light metering icon ( or ) is displayed if [Camera Setup]  [Light Metering] is set to [Backlight] or [Spotlight].

[Custom Picture]: Displays the custom picture icon () when set to [On], indicating that a custom picture profile will be recorded with a clip.

[ND Filter]: Displays the ND filter icons (ND , ND , ND ) when set to [On].

[Focus Mode]: Displays the focus mode icon (, , ) when set to [On].

[Object Distance]: Controls when the distance to the subject is displayed.

[Always On]: Always appears on the screen.

[Normal]: Appears only when operating the focus.

[Full Auto/Lock]: Displays the full auto icon () and lock icon () when set to [On].

[Infrared]: Displays [Infrared] and infrared light icons (, ) when set to [On].

[White Balance]: Displays the white balance indicator when set to [On].

[Exposure]: Displays the exposure bar when set to [On].

[Iris]: Displays the aperture setting when set to [On].

[Gain]: Displays the gain setting when set to [On].



[Shutter]: Displays the shutter speed setting when set to [On].

[Conversion Lens]: Displays the WD-H58W icon () and TL-H58 icon () when set to [On].

[Tele-converter]: Displays the digital tele-converter icon (, , ) when set to [On].

[Peaking]: Displays the peaking icon () or () when set to [On].

[Magnification]: Displays the screen magnification icon () when set to [On], indicating that the image on the screen is being magnified.

[OIS Functions]: Displays the image stabilizer icons (, ) and axis shift icon () when set to [On].

## Custom Display 2] settings

[Remaining Battery]: Controls when the remaining battery indicator appears.

[Warning]: Appears only when there is a warning.

[Normal]: Always appears on the screen.

[Remaining Rec Time]: Displays the remaining recording time.

[Warning]: Appears only when there is a warning.

[Normal]: Always appears on the screen.

[Rec Mode]: Displays the recording operation indicator ([STBY] in record pause mode, for example) when set to [On].

[Genlock]: Displays the Genlock icon () when set to [On].

[Time Code]: Displays the time code when set to [On].

[Interval Counter]: Displays the countdown during interval recording mode when set to [On].

[SD Card Status]: Controls when the SD card status indicator appears.



[Warning]: Appears only when there is a warning.

[Normal]: Always appears on the screen.

[Bit rate/Resolution]: Displays the bit rate and resolution when set to [On].

[Frame Rate]: Displays the frame rate when set to [On].

[Character Rec]: Displays the character recording warning icon () when set to [On], indicating that the onscreen displays will be recorded on the clip.

[Wireless Controller]: Displays the  icon when set to [On] if [Other Functions]  [Wireless Controller] is set to [Off] and the supplied wireless controller is operated.

[Output Display]: Displays the output display warning icon (**DISP**) when set to [On], indicating that the onscreen displays will be output to an external monitor.

[SDI Rec Command]: Displays the status of the [👉 Other Settings] [SDI Rec Command] setting.

[User Memo]: Displays the user memo icon (**MEMO**) when set to [On], indicating that a user memo will be recorded with a clip.

[User Bit]: Displays the user bit when set to [On].

[Audio Output CH]: Displays the audio output channel when set to [On].

[Date/Time]: Displays the date and time when set to [On].

### [00:00 TC/UB Setup] menu (CAMERA mode only)

Menu item	Submenu	Setting options	
[Time Code]	[Mode]	[Preset], [Regen.]	69
	[Run]	[Rec Run], [Free Run]	69
	[Setting]	[Set], [Reset]	69
[User Bit]	[Rec Mode] ( <b>XF105</b> only)	[Internal], [External]	73
	[Type]	[Setting], [Time], [Date]	71

### [👉 Other Functions] menu

Menu item	Submenu	Setting options	CAMERA	MEDIA	
[Reset]	[All Settings]	[Cancel], [OK]	●	●	-
	[Camera Settings]	[Cancel], [OK]	●	●	
	[Assignable Buttons]	[Cancel], [OK]	●	●	
[Transfer Menu]	[Save To ]	[Cancel], [OK]	●	●	106
	[Load From ]	[Cancel], [OK]	●	●	
[Time Zone]		List of world time zones. (UTC+01:00 Central Europe)	●	●	25
[Clock Set]	[Date/Time]	-	●	●	25
	[Date Format]	[YMD], [YMD/24H], [MDY], [MDY/24H], [DMY], [DMY/24H]	●	●	
[WFM (LCD)] <sup>1</sup>	[Setting]	[WFM], [Edge Mon.], [Off]	●	-	81
	[Setting]	[WFM], [Off]	-	●	81
	[Waveform Monitor]	[Line], [Line+Spot], [Field], [RGB], [YPbPr]	●	●	81
	[Gain]	[1x], [2x]	●	●	
	[Edge Monitor]	[Type 1], [Type 2]	●	-	82
[Language ]		[Deutsch], [English], [Español], [Français], [Italiano], [Polski], [Русский], [简体中文], [한국어], [日本語]	●	●	26
[Wireless Controller]		[On], [Off]	●	●	32
[Assign Button]	[1] to [10]	See footnote 2	●	● <sup>1</sup>	94
[Custom Key/Dial]	[Normal]	[Iris(ND)], [Face AF], [Headphone Volume], [Tele-converter], [Off]	●	-	46
	[Infrared]	[IR Light], [Headphone Volume], [Tele-converter], [Off]	●	-	
[Tally Lamp]	[Front]	[On], [Off]	●	-	-
	[Rear]	[On], [Off]			
[Media Access LED]		[On], [Off]	●	●	-

Menu item	Submenu	Setting options	CAMERA	MEDIA	
[Genlock/TC Term.](XF105 only)		[Gen/TC In], [TC Out]	●	–	72
[Genlock Adjust.](XF105 only)		-1023 to +1023 (000)	●	–	72
[Relay Rec]		[On], [Off]	●	–	37
[Double Slot Rec]		[On], [Off]	●	–	37
[Bit Rate/Resolution]		[50 Mbps 1920x1080], [50 Mbps 1280x720], [35 Mbps 1920x1080], [35 Mbps 1440x1080], [35 Mbps 1280x720], [25 Mbps 1440x1080]	●	–	45
[Frame Rate]		[50i], [50P], [25P]	●	–	45
[Special Rec]		[Interval Rec], [Frame Rec], [Pre Rec], [Slow & Fast Motion], [Off]	●	–	85
[Interval Rec]	[Interval]	[1 sec] to [10 sec], [15 sec], [20 sec], [30 sec], [40 sec], [50 sec], [1 min] to [10 min]	●	–	85
	[Rec Frames]	2, 6, 12	●	–	
[Frame Rec]	[Rec Frames]	2, 6, 12	●	–	86
[Slow & Fast Motion]	[S&F Frame Rate]	See footnote 3	●	–	
[Clips]	[Title Prefix]	[AA] to [ZZ]	●	–	–
	[Number setting]	[Set], [Reset]	●	–	–
	[Delete Last Clip]	[Cancel], [OK]	●	–	–
	[Copy All Clips]	[Cancel], [OK]	–	● <sup>4</sup>	116
	[Copy <input type="checkbox"/> Clips]	[Cancel], [OK]	–	● <sup>5</sup>	116
	[Delete All Clips]	[Cancel], [OK]	–	● <sup>4</sup>	117
[Delete All <input type="checkbox"/> Marks]		[Cancel], [OK]	–	● <sup>5</sup>	115
[Rec Review]		[Entire Clip], [Last 4 sec]	●	–	84
[Set Metadata]	[User Memo]	[Off], list of user memo files			79
	[Country Code]	Letters A to Z, numbers 0 to 9, plus sign (+), minus sign (-), colon (:), space	●	–	–
	[Organization]				
	[User Code]				
[SDI Rec Command] (XF105 only)		[On], [Off]	●	–	–
[Photo Numbering]		[Reset], [Continu.]	●	● <sup>1</sup>	138
[Add <input type="checkbox"/> File]	[To Clip]	[On], [Off]	●	–	99
	[To Photo]	[On], [Off]			
[Delete All Photos]		[Cancel], [OK]	–	● <sup>6</sup>	136

Menu item	Submenu	Setting options	CAMERA	MEDIA	
[Custom Function]	[Shockless Gain]	[Fast], [Normal], [Slow], <b>[Off]</b>	●	–	104
	[Shockless WB]	[On], <b>[Off]</b>	●	–	
	[AE Response]	[Fast], <b>[Normal]</b> , [Slow]	●	–	
	[Iris Limit]	[On], <b>[Off]</b>	●	–	
	[I. Ring Direction]	[Reverse], <b>[Normal]</b>	●	–	
	[F. Ring Direction]	[Reverse], <b>[Normal]</b>	●	–	
	[Z. Ring Direction]	[Reverse], <b>[Normal]</b>	●	–	
	[F. Ring Control]	[Fast], <b>[Normal]</b> , [Slow]	●	–	
	[Z. Ring Control]	[Fast], <b>[Normal]</b> , [Slow]	●	–	
	[F. Assist. B&W]	[Both], [Magnify], [Peaking], <b>[Off]</b>	●	–	
	[Obj. Dist. Unit]	<b>[Meters]</b> , [Feet]	●	–	
	[Zoom Indicator]	<b>[Bar]</b> , [Number]	●	–	
	[ZR-2000 AE SHIFT]	<b>[AE Shift]</b> , [Iris]	●	–	
	[Scan Reverse Rec]	[Both], [Vertical], [Horizontal], <b>[Off]</b>	●	–	
[Character Rec]	[On], <b>[Off]</b>	●	–		
[Reset Hour Meter]		<b>[Cancel]</b> , [OK]	●	●	–
[Initialize Media]	[CF A]	<b>[Cancel]</b> , [OK]	●	●	36
	[CF B]				
	[SD Card]	[Complete], [Quick]	●	●	
[Firmware]		–	●	–	–

<sup>1</sup> Not available in the [Photos] index screen.

<sup>2</sup> Setting options for [Assign Button]: [(NONE)], [Img Stab.], [Powered IS], [Focus Limit], [Face AF], [Select Face], [Backlight], [Spotlight], [Tele-converter], [Peaking], [Zebra], [WFM (LCD)], [Magnification], [TL-H58], [WD-H58W], [Color Bars], [IR Monochrome], [IR Light], [Markers], [LCD Setup], [LCD/VF B&W], [Onscreen Display], [Add Shot Mark 1], [Add Shot Mark 2], [Add  Mark], [Add  Mark], [Time Code], [Time Code Hold], [Audio Output CH], [Audio Level], [Wireless Controller], [Photo], [Delete Last Clip], [Status].

<sup>3</sup> The default settings are as follows. [1]: [Powered IS], [2]: [Zebra], [3]: [WFM (LCD)], [4]: [Magnification], [5] to [10]: [(NONE)].

<sup>4</sup> [12], [15], [18], [20], [21], [22], [23], [24], [25]

When [Bit Rate/Resolution] is set to [50 Mbps 1280x720] or [35 Mbps 1280x720], you can also select:

[26], [27], [28], [30], [32], [34], [37], [42], [45], [48], [50]

<sup>4</sup> Available in the clip index screen only.

<sup>5</sup> Available in the clip index screen and [ Mark] index screen only.

<sup>6</sup> Available in the [Photos] index screen only.

## [Reset]

**[All Settings]:** Resets all of the camcorder settings except for the hour meter to default settings.

**[Camera Settings]:** Resets all [**■** Camera Setup] settings and custom picture settings to default settings. In addition, the white balance, aperture, focus and gain are set to auto and the shutter speed is set to off.

**[Assignable Buttons]:** Resets the assignable buttons to default settings.

**[Tally Lamp]:** Allows you to set whether the front and rear tally lamps illuminate while the camcorder is recording.

**[Media Access LED]:** Allows you to set whether the CF card access indicators or the SD card access indicator illuminates while the camcorder is accessing a CF card or SD card.

**[Title Prefix]:** Determines the first 2 letters of the clip name. Combined with the [Number Setting] setting, this constitutes the 6-character clip name.

**[Number Setting]:** Determines the last 4 digits of the clip name. Combined with the [Title Prefix] setting, this constitutes the 6-character clip name. Select [Set] to assign a desired number to the first clip you record or select [Reset] to reset the number to [0001]. The numerals increase every time a clip is recorded.

**[Delete Last Clip]:** Deletes the last clip you recorded. This setting option will not appear if you turned the camcorder off since recording the last clip.



[Country Code]: This identifier is the country code defined by ISO-3166-1 and is to be entered starting from the left.

[Organization]: This identifier represents the organization that owns or operates the camcorder and can be obtained by registering with the SMPTE Registration Authority. If the organization is not registered, enter [0000].

[User Code]: This identifier designates the user. Leave this blank if [Organization] is set to [0000].

[SDI Rec Command]: When you connect the camcorder to another device using the HD/SD SDI terminal, if you start or stop recording with the camcorder, the other device will also start or stop recording.

[Delete All Photos]: Deletes all the photos recorded on the SD card.

[Reset Hour Meter]: The camcorder has two “hour meters” – the first keeps track of total operation time and the second keeps track of operation time since the last time the second hour meter was reset with this function.

[Firmware]: You can verify the current version of the camcorder’s firmware. This menu option is usually unavailable.

## Displaying the Status Screens

You can use the status screens to check the camcorder's various recording- and playback-related settings. You can also output the status screens on an external monitor.

Operating modes: CAMERA MEDIA

1 Set an assignable button to [Status] (📖 95).

2 Press the assignable button.

- The status screen most recently displayed will appear unless you turned off the camcorder or changed the operating mode. In such case, the [Camera] status screen appears in CAMERA mode and the [Buttons / Remote] status screen appears in MEDIA mode.

3 Push the joystick up/down to scroll through the status screens.

4 When you are finished, press the assignable button again to exit the status screens.

- Alternatively, you can press the MENU or CANCEL button. Pressing the MENU button will exit the status screen and open the menu.

Status screen	Description	CAMERA	MEDIA	📖
[Camera]	Displays settings related to recording, such as gain, focus and zoom.	●	–	151
[Buttons/Remote]	Allows you to verify the current function of each assignable button and whether the wireless controller is on.	●	●	151
[Audio]*	Displays settings related to audio.	●	●	152
[Media]	Displays information about the recording media.	●	●	152
[Video]	Displays the settings for the video terminals and which special recording mode is in effect.	●	●	153
[User Memo]	Displays the user memo that will be recorded with clips.	●	–	153
[Battery/Hour Meter]	Allows you to check the remaining battery time, battery life and how long the camcorder has been in operation.	●	●	154
[CP] Data 1/3	Displays the settings for the custom picture file that will be embedded into clips.	●	–	154
[CP] Data 2/3				155
[CP] Data 3/3				155

\* Does not appear in the [Photos] index screen.

**[Camera] Status Screen** (CAMERA mode)

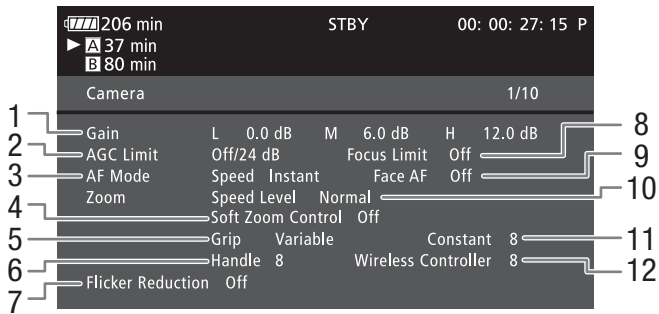

- |   |   |
|---|---|
| 1 Gain (📖 53)                             | 7 Flicker reduction (📖 56)                  |
| 2 Gain limit (📖 53)                       | 8 Focus limit (📖 51)                        |
| 3 Autofocus mode (📖 49)                   | 9 Face AF (📖 50)                            |
| 4 Soft zoom control (📖 139)               | 10 Zoom speed level (📖 63)                  |
| 5 Grip zoom rocker setting (📖 63)         | 11 Zoom speed of grip zoom rocker (📖 63)    |
| 6 Zoom speed of handle zoom rocker (📖 64) | 12 Zoom speed of wireless controller (📖 65) |

**[Buttons/Remote] Status Screen**

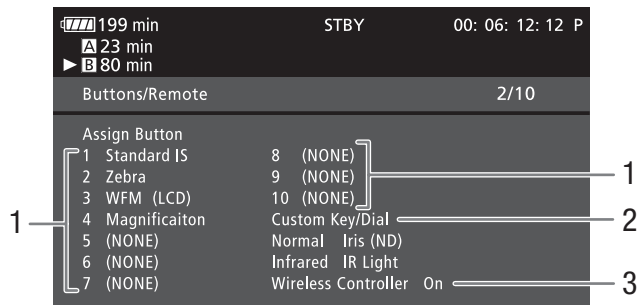

- |                                      |                              |
|--------------------------------------|------------------------------|
| 1 Assignable buttons 1 to 10* (📖 94) | 3 Wireless controller (📖 32) |
| 2 Custom key/dial (📖 46)             |                              |

\* In MEDIA mode, only buttons 1 to 4 and [Wireless Controller] appear.

## [Audio] Status Screen

In **CAMERA** mode

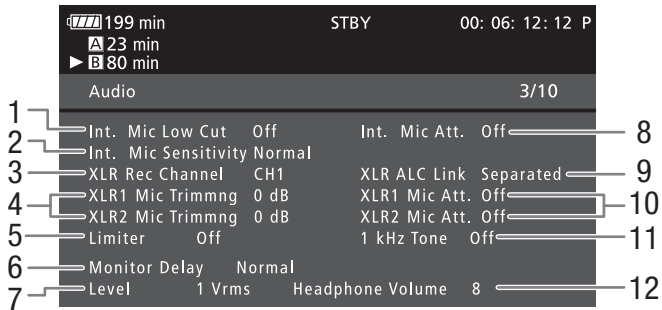

In **MEDIA** mode

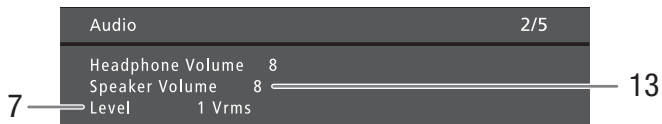

- |  |   |
|--|---|
| 1 Built-in microphone low-cut filter (📖 74)                    | 8 Microphone attenuator (built-in microphone and microphone connected to MIC terminal) (📖 75) |
| 2 Built-in microphone sensitivity (📖 74)                       | 9 Linking recording levels of XLR terminals (📖 77)  |
| 3 XLR terminal recording channel (📖 76)                        | 10 Microphone attenuator (microphones connected to XLR terminals) (📖 77)                      |
| 4 Sensitivity of microphones connected to XLR terminals (📖 76) | 11 Audio reference signal (📖 80)  |
| 5 Audio limiter (📖 78)   | 12 Headphone volume (📖 111)   |
| 6 Audio output delay (📖 126)                                   | 13 Speaker volume (📖 112)   |
| 7 Audio output level of the AV terminal (📖 127)                |   |

## [Media] Status Screen

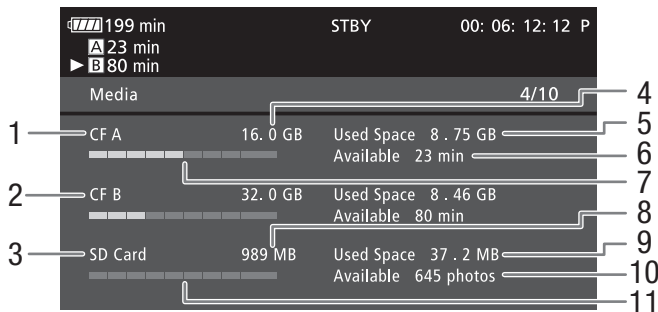

- |   |   |
|---|---|
| 1 CF card A                             | 7 Approximate used space on CF card A   |
| 2 CF card B                             | 8 Total space on SD card                |
| 3 SD card                               | 9 Used space on SD card                 |
| 4 Total space on CF card A              | 10 Available number of shots on SD card |
| 5 Used space on CF card A               | 11 Approximate used space on SD card    |
| 6 Available recording time on CF card A |   |

### **i** NOTES

- Depending on the recording media, the total space displayed on the screen may differ from the capacity listed on the CF card or SD card.

## [Video] Status Screen

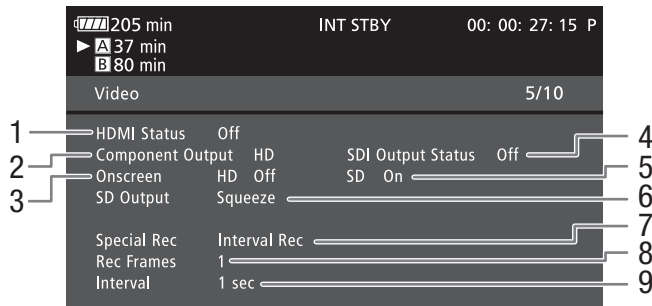

- |   |   |
|---|---|
| 1 HDMI OUT terminal status (📖 124)                              | 5 Superimposing onscreen displays to SD output (📖 125)                                |
| 2 HD/SD SDI terminal output setting ( <b>XF105</b> only, 📖 124) | 6 SD output setting (📖 122)   |
| 3 Superimposing onscreen displays to HD output (📖 125)          | 7 Special recording mode* (📖 85)  |
| 4 HD/SD COMPONENT OUT terminal output status (📖 124)            | 8 Number of frames for interval recording mode (📖 85) or frame recording mode* (📖 86) |
|   | 9 Interval length for interval recording mode* (📖 85)                                 |

\* In **CAMERA** mode only.

## [User Memo] Status Screen (**CAMERA** mode)

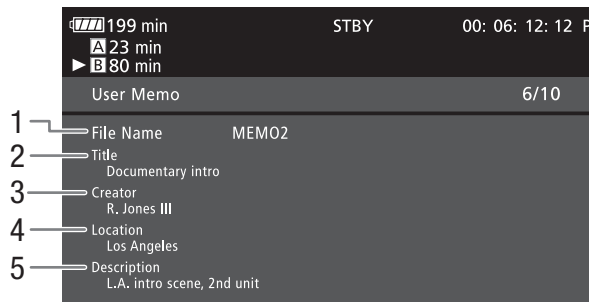

- |                       |                    |
|-----------------------|--------------------|
| 1 User memo file name | 4 Filming location |
| 2 Clip title          | 5 Clip description |
| 3 Camera operator     |                    |

### [Battery/Hour Meter] Status Screen

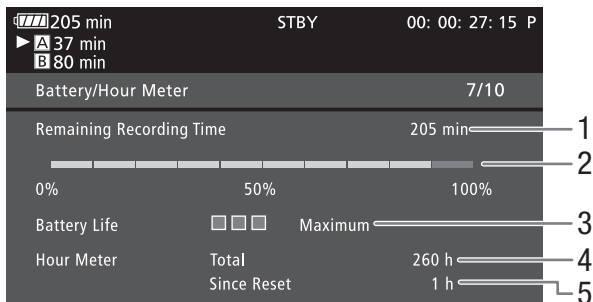

- 1 Remaining recording time
- 2 Remaining recording time indicator
- 3 Battery life indicator
- 4 Total operation time (📖 149)
- 5 Operation time since using [Reset Hour Meter] (📖 149)

### [CP Data 1/3] Status Screen (CAMERA mode)

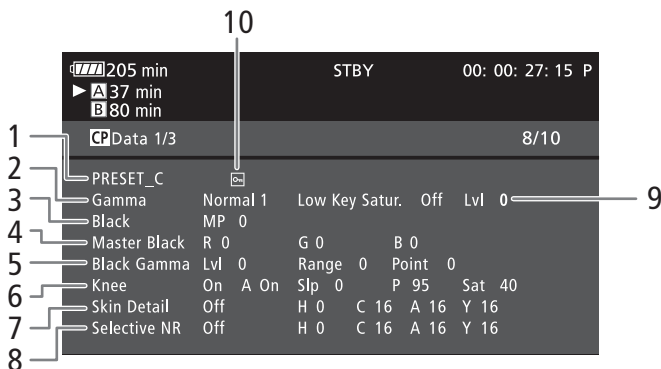

- 1 Custom picture file name (📖 96)
- 2 Gamma (📖 99)
- 3 Master pedestal (📖 99)
- 4 Master black RGB levels (📖 100)
- 5 Black gamma settings (level, range and point) (📖 100)
- 6 Knee settings (automatic, slope, point and saturation) (📖 100)
- 7 Skin detail settings (hue, chroma, area and Y level) (📖 101)
- 8 Selective NR settings (hue, chroma, area and Y level) (📖 102)
- 9 Low key saturation (📖 100)
- 10 Protected file (📖 97)

[CP] Data 2/3] Status Screen (CAMERA mode)

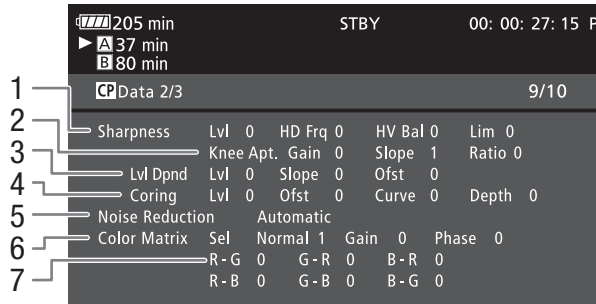

- |  |  |
|--|--|
| <ul style="list-style-type: none"> <li>1 Sharpness settings (level, horizontal detail frequency, horizontal/vertical detail balance, and limit) (📖 101)</li> <li>2 Sharpness settings (knee aperture, gain and ingredient ratio) (📖 101)</li> <li>3 Level depend settings (level, slope and offset) (📖 101)</li> </ul> | <ul style="list-style-type: none"> <li>4 Coring settings (level, offset, curve and depth) (📖 101)</li> <li>5 Noise reduction (📖 101)</li> <li>6 Color matrix settings (select, gain and phase) (📖 102)</li> <li>7 Color matrix settings (R-G, G-R, B-R, R-B, G-B and B-G) (📖 102)</li> </ul> |
|--|--|

[CP] Data 3/3] Status Screen (CAMERA mode)

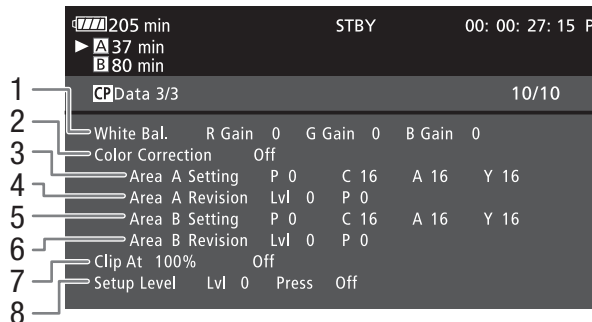

- |  |   |
|--|---|
| <ul style="list-style-type: none"> <li>1 White balance RGB gain (📖 102)</li> <li>2 Color correction (📖 103)</li> <li>3 Area A settings (phase, chroma, area and Y level) (📖 103)</li> <li>4 Area A revision settings (level and phase) (📖 103)</li> <li>5 Area B settings (phase, chroma, area and Y level) (📖 103)</li> </ul> | <ul style="list-style-type: none"> <li>6 Area B revision settings (level and phase) (📖 103)</li> <li>7 Clip at 100% (📖 103)</li> <li>8 Setup level and press (📖 103)</li> </ul> |
|--|---|

## Troubleshooting

If you have a problem with your camcorder, refer to this section. Consult your dealer or a Canon Service Center if the problem persists.

### Power source

**The camcorder will not turn on or it turns off by itself.**

- The battery pack is exhausted. Replace or charge the battery pack.
- Remove the battery pack and reattach it correctly.

**Cannot charge the battery pack.**

- The temperature of the battery pack is outside the charging range. If the battery pack's temperature is below 0 °C, warm it before charging it; if it is above 40 °C, let the battery pack cool down before charging it.
- Charge the battery pack in temperatures between 0 °C and 40 °C.
- The battery pack is faulty. Replace the battery pack.

**The battery pack is exhausted extremely quickly even at normal temperatures.**

- Check the [Battery / Hour Meter] status screen (☞ 150) to see whether the battery pack is at the end of its service life. If so, buy a new battery pack.

### Recording

**Pressing the START/STOP button will not start recording.**

- The CF card is full or it already contains the maximum number of clips (999 clips). Delete some clips (☞ 117) or save your clips (☞ 128) and initialize the CF card (☞ 36) to free some space. Alternatively, replace the CF card.
- The START/STOP lock lever on the handle is set to , rendering the handle's START/STOP button inoperable. Change the position of the lock lever.

**The point where the START/STOP button was pressed does not match the beginning/end of the recording.**

- There is a slight interval between pressing the START/STOP button and the actual start/end of recording. This is not a malfunction.

**The camcorder will not focus.**

- The camcorder may not be able to focus with autofocus on some subjects. Focus manually (☞ 47).
- The viewfinder is not adjusted. Use the dioptic adjustment lever to make the proper adjustment (☞ 29).
- The lens or Instant AF sensor is dirty. Clean the lens or sensor with a soft lens-cleaning cloth (☞ 165). Never use tissue paper to clean the lens.

**When a subject flits across in front of the lens, the image appears slightly bent.**

- This is a phenomenon typical of CMOS image sensors. When a subject crosses very quickly in front of the camcorder, the image may seem slightly warped. This is not a malfunction.

**Changing between recording (●REC) and record pause (STBY) takes longer than usual.**

- When the CF card contains a large number of clips, some operations may take longer than usual. Save your clips (☞ 128) and initialize the CF card (☞ 36). Alternatively, replace the CF card.

**The camcorder cannot record to a CF card properly.**

- This may occur as recordings are made and deleted over time. Save your clips (☞ 128) and initialize the CF card (☞ 36).

**After using the camcorder for a long time, it becomes hot.**

- The camcorder may become hot after using it continuously for long periods of time; this is not a malfunction. If the camcorder becomes unusually hot or it becomes hot after using it only for a short while, it may indicate a problem with the camcorder. Consult a Canon Service Center.





## Playback

### Cannot delete a clip.

- You cannot delete clips with an  mark. Remove the  mark ( 115) to delete the clip.

### Deleting clips takes longer than usual.

- When the CF card contains a large number of clips, some operations may take longer than usual. Save your clips ( 128) and initialize the CF card ( 36).

### Cannot delete a photo.

- The photo is protected. Remove the protection ( 97).
- The LOCK switch on the SD card is set to prevent accidental erasure. Change the position of the LOCK switch.

### Cannot copy clips.

- There is not enough available space on the CF card being copied to or the CF card already contains the maximum number of clips (999 clips). Delete some clips ( 117) to free some space or replace the CF card.

## Indicators and Onscreen Displays

### lights up in red.

- Battery pack is exhausted. Replace or charge the battery pack.

### appears on the screen.

- The camcorder cannot communicate with the attached battery pack so the remaining battery time cannot be displayed. Replace the battery pack with one that can communicate with the camcorder.

### The tally lamps do not illuminate.

- Set [Other Functions]  [Tally Lamp]  [Front] or [Rear] to [On].

### The tally lamps flash quickly (4 flashes per second).

- The battery pack is exhausted. Replace or charge the battery pack.
- There is not enough available space on the CF card. Delete some clips ( 117) to free some space or replace the CF card.
- A system error has occurred. Turn off the camcorder and back on again. If this does not solve the problem, consult a Canon Service Center.

### The tally lamps flash slowly (1 flash per second).

- The combined available space on both CF cards is low. Replace the CF card that is not being recorded onto.

### appears in red on the screen.

- An SD card error occurred. Turn off the camcorder. Remove and reinsert the SD card. Initialize the SD card if the display does not change back to normal.
- The SD card is full. Replace the SD card or delete some photos ( 135) to free some space on the SD card.

### Even after stopping recording, the CF /CF access indicator stays illuminated in red.



- The clip is being recorded. This is not a malfunction.

## Picture and Sound

### Screen displays turn on and off repeatedly.

- The battery pack is exhausted. Replace or charge the battery pack.
- Remove the battery pack and reattach it correctly.

### Abnormal characters appear on the screen and the camcorder does not operate properly.

- Disconnect the power source and reconnect it after a short time. If the problem still persists, perform one of the following actions.
  - Disconnect the power source and press the RESET button. This resets all the camcorder's settings to default values except for custom picture settings and the hour meter.
  - Use the [Other Functions]  [Reset]  [All Settings] function. This resets all the camcorder's settings to default values except for the hour meter.

### Video noise appears on screen.

- Keep a distance between the camcorder and devices that emit strong electromagnetic fields (plasma TVs, cellular phones, etc.).

**Horizontal bands appear on the screen.**

- This is a phenomenon typical of CMOS image sensors when recording under some types of fluorescent, mercury or sodium lamps. To reduce the symptoms, set [Camera Setup] Ⓞ [Flicker Reduction] to [Automatic] (☞ 56). This is not a malfunction.

**Audio cannot be recorded.**

- The AUDIO IN switch is not set correctly (☞ 74).
- An external microphone connected to the XLR terminal requires phantom power. Set the XLR terminal switch to MIC+48V (☞ 76).

**Audio is recorded at an extremely low level.**

- The audio level switch is set to M, and the recording level is set too low. Check the audio level meter on the LCD screen and adjust the audio level correctly (☞ 78).
- The microphone attenuator is on. Turn off the microphone attenuator of the built-in microphone or external microphone (☞ 75).

**Sound is distorted or is recorded at lower levels.**

- When recording near loud sounds (such as fireworks, shows or concerts), sound may become distorted or it may not be recorded at the actual levels. Activate the microphone attenuator of the built-in microphone or external microphone (☞ 75), or adjust the audio recording level manually.

**The picture is displayed correctly but there is no sound from the built-in speaker.**

- Speaker volume is turned off. Adjust the volume (☞ 112).
- If headphones are connected to the camcorder, disconnect them.

## Recording Media and Accessories

**Cannot insert the recording media.**

- The CF card or SD card you are trying to insert is not facing the correct direction. Turn it over and insert it.

**Cannot record on the CF card.**

- A compatible CF card must be used (☞ 34).
- Initialize the CF card (☞ 36) when you use it with the camcorder for the first time.
- The CF card is full or it already contains the maximum number of clips (999 clips). Delete some clips (☞ 117) to free some space or replace the CF card.

**Cannot record on the SD card.**

- Initialize the SD card (☞ 36) when you use it with the camcorder for the first time.
- The LOCK switch on the SD card is set to prevent accidental erasure. Change the position of the LOCK switch.
- The SD card is full. Delete some photos (☞ 135) to free some space or replace the SD card.
- The folder and file numbers have reached their maximum value. Set the [Other Functions] Ⓞ [Photo Numbering] setting to [Reset] and insert a new SD card.

**Recording to and playing back from a CF card is slow.**

- This may occur as video is recorded/deleted over time. Save your clips (☞ 128) and initialize the CF card (☞ 36).

**Recording to and playing back from an SD card is slow.**

- This may occur as photos are recorded/deleted over time. Save your photos and initialize the SD card (☞ 36).

**The wireless controller will not work.**

- Set [Other Functions] Ⓞ [Wireless Controller] to [On].
- Replace the battery of the wireless controller.

## Connections with External Devices

**Video noise appears on a nearby TV screen.**

- When using the camcorder in a room where a TV is located, keep a distance between the compact power adapter and the power or antenna cables of the TV.

**Playback looks fine on the camcorder but there is no image on the external monitor.**

- The camcorder is not connected correctly to the external monitor. Make sure you are using the correct connection (☞ 123).
- The video input on the external monitor is not set to the video terminal to which you connected the camcorder. Select the correct video input.

**There is no sound from the external monitor.**

- When connecting the camcorder to an external monitor using the CTC-100/S Component Cable, make sure to connect also the audio connections using the white and red plugs of the optional STV-250N Stereo Video Cable.



**The camcorder is connected using a commercially available HDMI cable, but there is no picture or sound from the external monitor.**

- Disconnect the HDMI cable and then restore the connection or turn the camcorder off and then on again.

**The computer does not recognize the camcorder even though the camcorder is connected correctly.**

- Disconnect the USB cable and turn off the camcorder. After a short while, turn it on again and restore the connection.
- Connect the camcorder to a different USB port on the computer.

## List of Messages

Refer to this section if a message appears on the screen. The message will be displayed in the language according to the [Other Functions]  [Language 

**Accessing CF A/CF B Do not remove**

- You opened the CF card slot cover while the camcorder was accessing the CF card. Close the CF card slot cover.
- You opened the CF card slot cover while the camcorder was recording in double slot recording mode. Close the CF card slot cover.
  - During double slot recording, both "CF A" and "CF B" will appear in the message.

**Cannot acquire battery information**

- Battery information can be displayed only for batteries bearing the Intelligent System mark.

**Cannot communicate with the battery pack. Continue using this battery pack?**

- You attached a battery pack that does not bear the Intelligent System mark.
- If you are using a battery pack that bears the Intelligent System mark, there may be a problem with the camcorder or battery pack. Consult a Canon Service Center.

**Cannot play back**

- The file control information is corrupted or there was a decoder error. Turn off the camcorder and back on again. If this does not solve the problem, consult a Canon Service Center.
  - Corrupted file control information cannot be recovered. CF cards or clips with corrupt file control information cannot be read by the Canon XF Utility software or associated plugins.

**Cannot record**

- There was an encoder error. Turn off the camcorder and back on again. Then, remove the CF card being used and reinsert it. Alternatively, replace the CF card. If this does not solve the problem, consult a Canon Service Center.



**Cannot switch CF card slots**

- The SLOT SELECT button was pressed while the camcorder is recording. Wait until recording is finished to change the selected CF card slot.

**CF A/CF B Buffer overflow. Recording was stopped.**

- The data transfer rate was too high for the CF card in use and the recording was stopped. Use a recommended card ( 34).

**CF A/CF B Cannot restore**

- Could not recover data on the CF card. Save your clips ( 128) and initialize the CF card ( 36).



**CF A/CF B error**

- The CF card cannot be recognized or cannot be accessed. Check that the CF card is inserted correctly and not malfunctioning.

**CF A/CF B Management data is not supported and will be deleted**

- This message may appear if you insert into the camcorder a CF card that was initialized by another Canon professional camcorder. Check the content of the CF card.

**CF A/CF B Management file error Cannot record**

- Cannot record because the camcorder cannot write to the file control information. This may occur if the files on the CF card were accessed using another device. Save your clips ( 128) and initialize the CF card ( 36).
  - During double slot recording, both "CF A" and "CF B" will appear in the message.

**CF A/CF B Media full**

- CF card A or CF card B is full so recording will not start. Switch to the CF card in the other CF card slot to record.

**CF A/CF B Number of clips already at maximum**

- The CF card already contains the maximum number of clips (999 clips). Replace the CF card or use the CF card in the other CF card slot.
- Because both CF cards reached the maximum number of clips, double slot recording is not available.
  - During double slot recording, both “CF A” and “CF B” will appear in the message.

**CF A/CF B Operation canceled.**

- The file control information is corrupt. Corrupted file control information cannot be recovered. CF cards or clips with corrupt file control information cannot be read by the Canon XF Utility software or associated plugins.
- When recording a single clip for an extended period of time, the clip will be split into smaller video files every 2 GB. This message will appear when the number of smaller video files reaches 99.

**CF A/CF B Recovering is completed Check the clip**

- The recovery process for data on the CF card is complete. Check the clips on the CF card.

**CF A/CF B Media is not supported**

- CF cards that are less than 512 MB or not UDMA-compatible cannot be used with the camcorder. Use a recommended CF card (☐ 34).

**CF A/CF B Using a card that supports UDMA mode 4 or higher is recommended**

- The CF card’s UDMA mode is lower than UDMA4. We recommend using a CF card that with a UDMA mode of at least UDMA4.

**CF A→CF B / CF B→CF A Switched**

- This message appears when you use the SLOT SELECT button to switch the CF card slot in use or recording continued from one CF card to the other.

**CF A→CF B / CF B→CF A Will switch in a moment**

- The CF card is almost full so recording will continue on the other CF card in approximately 1 minute.

**Change the battery pack**

- The battery pack is exhausted. Replace or charge the battery pack.

**Check data on CF A/CF B and initializing the card is recommended**

- The CF card cannot be used for any of the following reasons.
  - A problem has occurred with the CF card.
  - The camcorder cannot read the CF card’s data.
  - The CF card was initialized using a computer.
  - The CF card has been partitioned.
- Save your clips (☐ 128) and initialize the CF card (☐ 36).

**Check the SD card**

- The SD card cannot be accessed. Check that the SD card is inserted correctly and not malfunctioning.
- Due to an SD card error, photos cannot be taken or viewed. Remove and then reinsert the SD card or use a different SD card.

**Cover is open**

- The CF card slot cover was open when the camcorder was switched to or turned on in CAMERA mode. Close the cover.

**Data on CF A/CF B needs recovering Attempt to recover?**

- If data on the CF card is corrupted, such as when the power suddenly turned off while recording, the data must be recovered. When this message appears, select [Yes] and press SET.

**Do not disconnect the USB cable or the power source until you safely end the connection from the computer. Cannot write data with this connection. To write data to the camcorder, connect the compact power adapter then reconnect the camcorder and computer.**

- The camcorder cannot be operated while it is not being powered by the compact power adapter and is connected to a computer with a USB cable. In addition, clips cannot be written back to the camcorder. To avoid corrupting the data on the memory card, use the computer’s Safely Remove Hardware function to end the connection and disconnect the USB cable before using the camcorder.
- To be able to write back clips to the camcorder, use the computer’s Safely Remove Hardware function to end the connection, disconnect the USB cable, power the camcorder using the compact power adapter and only then connect it to the computer again.

**Do not disconnect the USB cable or the power source until you safely end the connection from the computer. Connect the compact power adapter**

- When the camcorder is in MEDIA mode and is connected to the computer with a USB cable, the camcorder cannot be operated. Disconnecting the USB cable or power source while this message appears may result in permanent loss of the clips on the memory card. Use the computer’s Safely Remove Hardware function to end the connection and disconnect the USB cable before using the camcorder.
- To be able to write back clips to the camcorder, power the camcorder using the compact power adapter and only then connect it to the computer using a USB cable.

**File name error**

- The folder and file numbers have reached their maximum value. Set [Other Functions] ➤ [Photo Numbering] to [Reset] and delete all the photos on the SD card (☞ 135) or initialize it (☞ 36).

**Invalid operation**

- The following operations cannot be performed.
  - Adding a shot mark to a frame that already has a shot mark or to a clip in frame recording mode or interval recording mode.
  - Adding an **OK** mark to clip that already has an **OK** mark or adding a **✓** mark to a clip that already has a **✓** mark.
  - In **CAMERA** mode, immediately reviewing a recording made in a special recording mode.
  - Pressing the START/STOP button when there is no CF card in the camcorder.

**Media full**

- CF card A and CF card B are full. Delete some clips (☞ 117) to free some space or replace a CF card.

**Media is almost full**

- The amount of available space on CF card A and CF card B combined is low. Replace the CF card that is not selected.

**No clips**

- There are no clips on the CF card to play back. Clips must be recorded (☞ 39) in order to play them back.

**No photos**

- There are no photos on the SD card to play back. Photos must be taken (☞ 132) in order to view them.

**No Shot Marks**

- This message appears if shot marks in a clip were deleted from the [Shot Mark] index screen. Press the INDEX button to return to the clip index screen.

**Number of Shot Marks at maximum**

- The shot mark could not be added because the clip already contains 100 shot marks (☞ 51 and ☞ 52 marks combined). You must delete shot marks (☞ 120) before adding any more.

**Recorded in NTSC standard Check data on CF A/CF B Initializing the card is also recommended**

- The CF card contains clips that are recorded in the NTSC system. Save your clips (☞ 128) and initialize the CF card (☞ 36).

**SD card error**

- You inserted a MultiMedia Card (MMC) into the camcorder. Use a recommended SD card (☞ 34).

**Shot Mark Error**

- Could not add a shot mark. If the message appears in **CAMERA** mode, try adding the mark again. If that does not work, add the mark in **MEDIA** mode after you finish recording. If the message appears in **MEDIA** mode, turn off the camcorder and then back on. Then, try to add the mark again.

**System error**

- Turn off the camcorder and back on again. If this does not solve the problem, there may be a malfunction with the camcorder. Consult a Canon Service Center.

**This photo cannot be displayed**

- You may not be able to display photos taken with other devices or image files created or edited on a computer.

**✓ Mark Error**

- Could not add a **✓** mark. If the message appears in **CAMERA** mode, try adding the mark again. If that does not work, add the mark in **MEDIA** mode. If the message appears in **MEDIA** mode, turn off the camcorder and then back on. Then, try to add the mark again.

**OK Mark Error**

- Could not add an **OK** mark. If the message appears in **CAMERA** mode, try adding the mark again. If that does not work, add the mark in **MEDIA** mode. If the message appears in **MEDIA** mode, turn off the camcorder and then back on. Then, try to add the mark again.

## Handling Precautions

### Camcorder

Be sure to observe the following precautions to ensure maximum performance.

- Do not carry the camcorder by the LCD panel. Be careful when closing the LCD panel.
- Do not leave the camcorder in places subject to high temperatures (like the inside of a car parked under direct sunlight), or high humidity.
- Do not use the camcorder near strong electromagnetic fields such as above TVs, near plasma TVs or mobile phones. Using the camcorder in such places may cause anomalies in the video or audio or video noise to appear.
- Do not use or store the camcorder in dusty or sandy places. The camcorder is not waterproof – avoid also water, mud or salt. If any of the above should get into the camcorder it may damage the camcorder and/or the lens.
- Do not point the camcorder or viewfinder toward an intense light source, such as the sun on a sunny day or an intense artificial light source. Doing so may damage the image sensor or the camcorder's internal components. Be careful especially when using a tripod or shoulder strap.
- Be careful of heat generated by lighting equipment.
- Do not disassemble the camcorder. If the camcorder does not function properly, consult qualified service personnel.
- Handle the camcorder with care. Do not subject the camcorder to shocks or vibration as this may cause damage. When using the shoulder strap, do not allow the camcorder to swing and hit an object.
- When mounting the camcorder on a tripod, make sure that the tripod's fastening screw is shorter than 5.5 mm. Using other tripods may damage the camcorder.
- To prevent equipment breakdowns and excessive heating, do not connect the supplied compact power adapter to voltage converters for overseas travels or special power sources such as those on aircraft and ships, DC-AC inverters, etc.

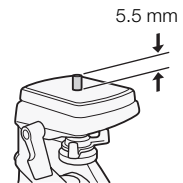

### Long-term storage

If you do not intend to use the camcorder for a long time, store it in a place free of dust, in low humidity, and at temperatures not higher than 30 °C.

### Battery Pack

#### **DANGER!**

**Treat the battery pack with care.**

- Keep it away from fire (or it might explode).
- Do not expose the battery pack to temperature higher than 60 °C. Do not leave it near a heater or inside a car in hot weather.
- Do not try to disassemble or modify it.
- Do not drop it or subject it to shocks.
- Do not get it wet.

- Dirty terminals may cause a poor contact between the battery pack and the camcorder. Wipe the terminals with a soft cloth.

### Long-term storage

- Store battery packs in a dry place at temperatures no higher than 30 °C.
- To extend the battery life of the battery pack, discharge it completely before storing it.
- Charge and discharge all your battery packs fully at least once a year.

### Always attach the battery terminal cover.

Do not allow any metal objects to touch the terminals (figure 1), as this can cause a short circuit and damage the battery pack. Attach the terminal cover whenever the battery pack is not being used (figure 2).

The battery terminal cover has a [ ]-shaped hole. This is useful when you wish to differentiate between charged and uncharged battery packs. For example, with charged battery packs, attach the terminal cover so that the [ ]-shaped hole shows the colored label.

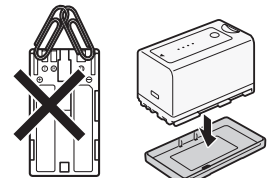
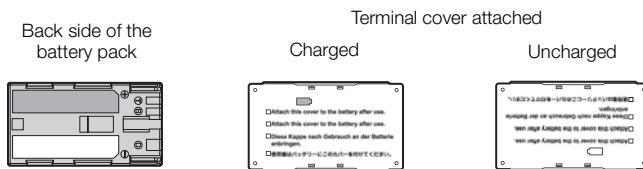

Figure 1

Figure 2



### Remaining battery time

If the remaining battery time displayed is not correct, charge the battery pack fully. Still, the correct time may not be displayed if a fully charged battery pack is used continuously in high temperatures or it is left unused for long periods of time. Also, the correct remaining time may not be displayed, depending on the battery life. Use the time shown on the screen as an approximation.

### Regarding the use of non-Canon battery packs

- We recommend using genuine Canon battery packs bearing the Intelligent System  Intelligent Li-ion Battery mark.
- If you attach to the camcorder battery packs that are not genuine Canon battery packs, the remaining battery time will not be displayed.

### Recording Media

- We recommend backing up the recordings on the recording media onto your computer. Data may be corrupted or lost due to defects or exposure to static electricity. Canon shall not be liable for lost or corrupted data.
- Do not touch or expose the terminals to dust or dirt.
- Do not use recording media in places subject to strong magnetic fields.
- Do not leave recording media in places subject to high humidity and high temperature.
- Do not disassemble, bend, drop, or subject recording media to shocks and do not expose them to water.
- Check the direction before inserting the recording media. Forcing recording media into the slot if it is not correctly oriented may damage the recording media or the camcorder.
- Do not attach any labels or stickers on the recording media.

- **SD cards:** SD cards have a physical switch to prevent writing on the card so as to avoid the accidental erasure of the card's content. To write-protect the SD card, set the switch to the LOCK position.



## Built-in Rechargeable Lithium Battery

The camcorder has a built-in rechargeable lithium battery to keep the date/time and other settings. The built-in lithium battery is recharged while you use the camcorder; however, it will discharge completely if you do not use the camcorder for about 3 months.

**To recharge the built-in lithium battery:** Connect the DC cable and compact power adapter to the camcorder and use a household power outlet to power the camcorder for 24 hours while it is turned off.

## Lithium Button Battery

### WARNING!

- The battery used in this device may present a fire or chemical burn hazard if mishandled.
- Do not disassemble, modify, immerse in water, heat above 100 °C or incinerate the battery.
- Replace with a CR2025 battery made by Panasonic, Hitachi Maxell, Sony, Sanyo, or with Duracell2025. Use of other batteries may present a risk of fire or explosion.
- Do not insert the battery into the mouth. If swallowed, seek medical assistance immediately. The battery case may break and the battery fluids may cause internal injuries.
- Keep the battery out of the reach of children.
- Do not recharge, short-circuit or insert the battery in the wrong direction.
- The used battery should be returned to the supplier for safe disposal.

- Do not pick up the battery using tweezers or other metal tools, as this will cause a short circuit.
- Wipe the battery with a clean dry cloth to ensure proper contact.

## Disposal

When you delete data on the recording media, only the file allocation table is altered and stored data is not physically erased. When disposing of or giving the recording media to another person, initialize it using the [Initialize Media] option for CF cards or [Complete] initialization option for SD cards (▶ 36). Fill it up with unimportant recordings, and then initialize it again using the same option. This makes recovering the original recordings very difficult.



## Maintenance/Others

### Cleaning

#### Camcorder Body

- Use a soft, dry cloth to clean the camcorder body. Never use chemically treated cloths or volatile solvents such as paint thinner.

#### Lens and Instant AF Sensor

- If the lens surface or Instant AF sensor is dirty, autofocus may not work properly.
- Remove any dust or dirt particles using a non-aerosol type blower brush.
- Use a clean, soft lens-cleaning cloth to gently wipe the lens using commercially available cleaning fluid for eyeglasses. Never use tissue paper.

#### LCD Screen

- Clean the LCD screen using a clean, soft lens-cleaning cloth.
- Condensation may form on the surface of the screen when the temperature changes suddenly. Wipe it with a soft dry cloth.

### Condensation

Moving the camcorder rapidly between hot and cold temperatures may cause condensation (water droplets) to form on its internal surfaces. Stop using the camcorder if condensation is detected. Continued use may damage the camcorder.

#### Condensation may form in the following cases:

- When the camcorder is moved quickly from cold to warm places
- When the camcorder is left in a humid room
- When a cold room is heated rapidly

#### To avoid condensation

- Do not expose the camcorder to sudden or extreme changes in temperature.
- Remove the recording media and battery pack. Then, place the camcorder in an airtight plastic bag and let it adjust gradually to temperature changes before removing it from the bag.

#### When condensation is detected

The precise time required for water droplets to evaporate will vary depending on the location and weather conditions. As a general rule, wait for 2 hours before resuming use of the camcorder.

### Using the Camcorder Abroad

#### Power Sources

You can use the compact power adapter to operate the camcorder and to charge battery packs in any country with power supply between 100 and 240 V AC, 50/60 Hz. Consult a Canon Service Center for information on plug adapters for overseas use.

#### Playback on a TV Screen

You can only play back your recordings on TVs compatible with the PAL system. PAL (or the compatible SECAM system) is used in the following regions/countries:

**Europe:** All of Europe and Russia. **Americas:** Only in Argentina, Brazil, Uruguay and French territories (French Guiana, Guadeloupe, Martinique, etc.). **Asia:** Most of Asia (except in Japan, the Philippines, South Korea, Taiwan and Myanmar). **Africa:** All of Africa and African islands. **Australia/Oceania:** Australia, New Zealand, Papua New Guinea; most Pacific islands (except for Micronesia, Samoa, Tonga and US territories like Guam and American Samoa).

## Optional Accessories

The following optional accessories are compatible with this camcorder. The availability differs from area to area.

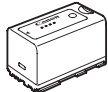

BP-925, BP-955,  
BP-975, BP-950G,  
BP-970G  
Battery Pack

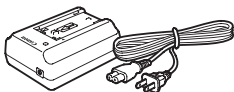

CA-930, CA-920  
Compact Power  
Adapter

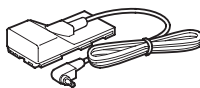

DC-920 DC Coupler

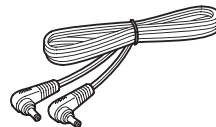

DC-930 DC Cable



CB-920 Car Battery  
Adapter

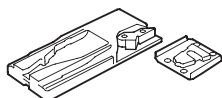

TA-100 Tripod Adapter



TB-1 Tripod Adapter  
Base

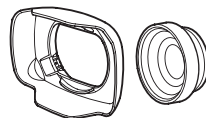

WD-H58W  
Wide-converter



TL-H58 Tele-converter

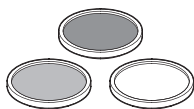

Protect Filter 58 mm,  
ND4L Filter 58 mm,  
ND8L Filter 58 mm



VL-10Li II Battery Video  
Light

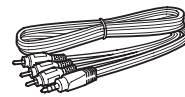

STV-250N Stereo Video  
Cable

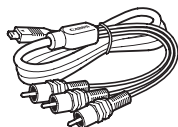

CTC-100  
Component Cable



ZR-2000 Zoom  
Remote Controller\*

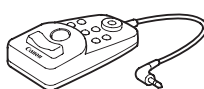

ZR-1000 Zoom  
Remote Controller\*

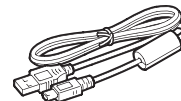

IFC-400PCU  
USB Cable

\* Discontinued products.

**Use of genuine Canon accessories is recommended.**

This product is designed to achieve excellent performance when used with genuine Canon accessories. Canon shall not be liable for any damage to this product and/or accidents such as fire, etc., caused by the malfunction of non-genuine Canon accessories (e.g., a leakage and/or explosion of a battery pack). Please note that this warranty does not apply to repairs arising out of the malfunction of non-genuine Canon accessories, although you may request such repairs on a chargeable basis.

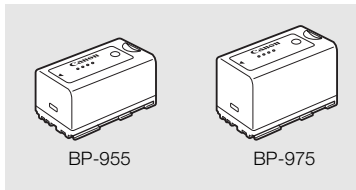
**Battery Packs**

When you need extra battery packs, select from the following: BP-925, BP-955, BP-975, BP-950G, BP-970G.

When you use battery packs bearing the Intelligent System mark, the camcorder will communicate with the battery and display the remaining usage time (accurate to 1 minute). You can only use and charge these battery packs with camcorders and chargers compatible with Intelligent System.

**Charging Times**

Use the CA-930 Compact Power Adapter to charge battery packs. The charging times given in the following table are approximate and vary according to charging conditions and initial charge of the battery pack.

BP-925	BP-955	BP-950G	BP-970G	BP-975
110 min.	200 min.	245 min.	350 min.	295 min.

**Recording and Playback Times**

Recording and playback times given in the following tables are approximate and vary according to recording mode and charging, recording or playback conditions. The effective usage time of the battery pack may decrease when recording in cold surroundings, when using the brighter screen settings, etc.

**XF105**

Bit rate	Usage time		BP-925	BP-955	BP-950G	BP-970G	BP-975
50 Mbps	Recording (maximum)	Viewfinder	165 min.	345 min.	350 min.	490 min.	520 min.
		LCD screen	165 min.	340 min.	345 min.	485 min.	510 min.
	Recording (typical)*	Viewfinder	105 min.	220 min.	220 min.	310 min.	320 min.
		LCD screen	105 min.	215 min.	215 min.	305 min.	315 min.
Playback	LCD screen	225 min.	460 min.	470 min.	655 min.	695 min.	
35 Mbps	Recording (maximum)	Viewfinder	165 min.	345 min.	350 min.	490 min.	520 min.
		LCD screen	165 min.	340 min.	345 min.	485 min.	510 min.
	Recording (typical)*	Viewfinder	105 min.	220 min.	220 min.	310 min.	320 min.
		LCD screen	105 min.	215 min.	215 min.	305 min.	315 min.
Playback	LCD screen	225 min.	465 min.	470 min.	675 min.	695 min.	
25 Mbps	Recording (maximum)	Viewfinder	170 min.	355 min.	360 min.	505 min.	530 min.
		LCD screen	170 min.	345 min.	355 min.	495 min.	525 min.
	Recording (typical)*	Viewfinder	105 min.	225 min.	225 min.	315 min.	325 min.
		LCD screen	105 min.	220 min.	220 min.	310 min.	320 min.
Playback	LCD screen	230 min.	475 min.	485 min.	680 min.	715 min.	

**XF100**

Bit rate	Usage time		BP-925	BP-955	BP-950G	BP-970G	BP-975
50 Mbps	Recording (maximum)	Viewfinder	205 min.	420 min.	430 min.	600 min.	635 min.
		LCD screen	200 min.	410 min.	420 min.	585 min.	625 min.
	Recording (typical)*	Viewfinder	130 min.	265 min.	275 min.	380 min.	400 min.
		LCD screen	125 min.	260 min.	270 min.	375 min.	390 min.
	Playback	LCD screen	290 min.	595 min.	610 min.	850 min.	905 min.
	35 Mbps	Recording (maximum)	Viewfinder	205 min.	420 min.	430 min.	600 min.
LCD screen			200 min.	410 min.	420 min.	590 min.	625 min.
Recording (typical)*		Viewfinder	130 min.	265 min.	275 min.	385 min.	400 min.
		LCD screen	125 min.	260 min.	270 min.	375 min.	390 min.
Playback		LCD screen	290 min.	600 min.	615 min.	855 min.	910 min.
25 Mbps		Recording (maximum)	Viewfinder	210 min.	430 min.	440 min.	615 min.
	LCD screen		205 min.	420 min.	430 min.	605 min.	640 min.
	Recording (typical)*	Viewfinder	130 min.	275 min.	280 min.	390 min.	410 min.
		LCD screen	130 min.	270 min.	275 min.	385 min.	400 min.
	Playback	LCD screen	300 min.	620 min.	635 min.	885 min.	940 min.

\* Approximate times for recording with repeated operations such as start/stop, zooming, and power on/off.

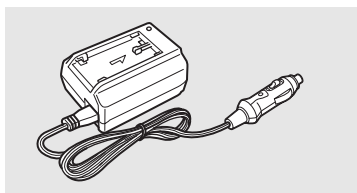

**CB-920 Car Battery Adapter**

Use the car battery adapter to power the camcorder or charge battery packs on the go. The car battery adapter plugs into your car's cigarette lighter socket and runs off a 12-24V DC negative ground battery.

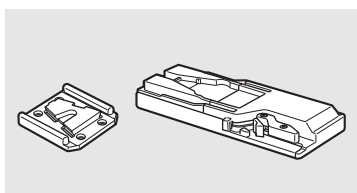

**TA-100 Tripod Adapter**

The TA-100 allows you to quickly mount/unmount the camcorder on/from a tripod.

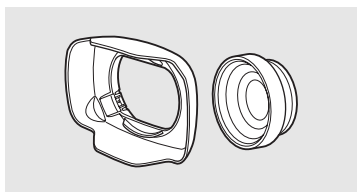

**WD-H58W Wide-converter**

The wide attachment decreases the camcorder's focal length by a factor of 0.8, allowing you to make recordings with a wider angle of view.

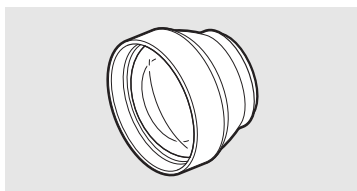

**TL-H58 Tele-converter**

This Tele-converter lens increases the focal length of the camcorder lens by a factor of 1.5.

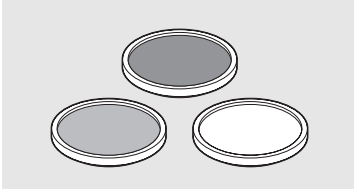

Protect Filter 58 mm, ND4L Filter 58 mm, ND8L Filter 58 mm  
Neutral density and MC protector filters help you to control difficult lighting conditions.

 This mark identifies genuine Canon video accessories. When you use Canon video equipment, we recommend Canon-brand accessories or products bearing the same mark.

## Specifications

### XF105 / XF100

#### System

- **Recording System**

Movies: Video compression: MPEG-2 Long GOP;  
Audio compression: Linear PCM, 16 bits, 48 kHz, 2 channels  
File type: MXF  
Photos: Image compression: JPEG  
DCF (Design rule for Camera File system), compatible with Exif Ver. 2.2

- **Video Configuration (recording/playback)**

50 Mbps (CBR, 4:2:2, 422P@HL)  
1920x1080: 50i, 25P  
1280x720: 50P, 25P  
35 Mbps (VBR, 4:2:0, MP@HL)  
1920x1080: 50i, 25P  
1440x1080: 50i  
1280x720: 50P, 25P  
25 Mbps (CBR, 4:2:0, MP@H14)  
1440x1080: 50i, 25P

- **Recording Media (not included)**

Movies: CompactFlash (CF) Card Type I (two slots)  
Photos: SD or SDHC (SD High Capacity) memory card\*  
\*Custom picture files, camera settings and user memo files can be saved and loaded.

- **Maximum Recording Time\*\***

16 GB CF Card  
50 Mbps: 40 min., 35 Mbps: 55 min., 25 Mbps: 80 min.  
64 GB CF Card  
50 Mbps: 160 min., 35 Mbps: 225 min., 25 Mbps: 310 min.

\*\*Approximate figures based on continuous recording.

- **Image Sensor:** 1/3-type CMOS, approx. 2,070,000 pixels (1920x1080)

- **LCD screen:** 8.8 cm (3.5 in.), wide, color, approx. 920,000 dots

- **Viewfinder:** 0.61 cm (0.24 in.), approx. 260,000 dots equivalent

- **Microphone:** Stereo electret condenser microphone

- **Lens**

f=4.25-42.5 mm, F1.8-2.8, 10x optical zoom  
35 mm equivalent: 30.4-304 mm

- **Lens Configuration**

12 elements in 10 groups (2 single-sided aspheric elements)

- **ND filter:** Built-in gradation ND filter

- **Filter diameter:** 58 mm

- **AF System**

Autofocus (TTL + external distance sensor when set to [Instant]) or Manual focus using manual ring

- **White Balance**

Auto white balance, custom white balance, preset white balance settings (daylight, 5,400 K\*\*\* and incandescent lamp, 3,200 K\*\*\*), or color temperature setting

\*\*\* Color temperatures are approximate and given for reference purposes only.

- **Iris:** Auto or manual setting
- **Gain:** Auto (AGC) or manual (-6.0 dB to 33.0 dB, fine-tuning available)
- **Shutter speed:** Auto, speed, angle, clear scan or slow shutter mode, off; 1/3 sec to 1/2000
- **Minimum Illumination:** 0.08 lux (CAMERA switch set to M (manual), [Frame Rate] at [50i], gain at 33 dB, shutter speed at 1/3)
- **Subject Illumination Range:** 0.08 to 10,000 lux (when the [Frame Rate] is [50i])
- **Image Stabilization:** Optical-Shift Image Stabilizer
- **Size of Video Recordings**  
50 Mbps, 35 Mbps: 1920x1080 pixels, 1440x1080 (35 Mbps only), 1280x720 pixels  
25 Mbps: 1440x1080 pixels
- **Size of Photos**  
1920x1080, 1280x720 (only when capturing a photo from a clip)

## Terminals

- **XF105 HD/SD SDI Terminal**  
BNC jack, output only, 0.8 V<sub>p-p</sub>/75 Ω, unbalanced  
HD-SDI: SMPTE 292M  
Video (1080i/720P), embedded audio, time code (VITC/LTC)  
SD-SDI: SMPTE 259M  
Video (576i), embedded audio, time code (VITC/LTC)
- **HDMI OUT Terminal**  
HDMI connector, output only
- **HD/SD COMPONENT OUT Terminal**  
720P (D4)/1080i (D3)/576i (D1) compatible, output only  
Luminance (Y): 1 V<sub>p-p</sub> / 75 Ω  
Chrominance (P<sub>b</sub>/P<sub>r</sub>): ±350 mV / 75 Ω
- **AV Terminal**  
Ø 3.5 mm mini jack (audio and video), output only  
Video: 1 V<sub>p-p</sub> / 75 Ω unbalanced  
Audio: -10 dBV (47 kΩ load, output level 1V<sub>rms</sub>) / 3 kΩ or less
- **XLR Terminal**  
XLR jack (pin1: shield, pin2: hot, pin3: cold), 2 sets  
Sensitivity  
MIC setting: -60 dBu (manual volume center, full scale -18 dB) / 600 Ω  
LINE setting: 4 dBu (manual volume center, full scale -18 dB) / 10 kΩ  
Microphone attenuator: 20 dB
- **MIC Terminal**  
Ø 3.5 mm stereo minijack (unbalanced)  
Sensitivity: 60 dBu (manual volume center, full scale -18 dB)  
Microphone attenuator: 20 dB
- **Ⓜ (Headphone) Terminal**  
Ø 3.5 mm stereo mini-jack, -∞ to -12 dBV (16 Ω load, volume range Min to Max) / 50 Ω or less

- **XF105** GENLOCK/TC Terminal  
BNC jack  
As GENLOCK terminal  
Input only: 1 Vp-p/75 Ω  
As TC (time code) terminal  
Input: 0.5 V - 18 Vp-p/10 kΩ  
Output: 1 Vp-p/75 Ω
- **REMOTE** Terminal  
Ø 2.5 mm stereo mini-jack
- **USB** Terminal  
mini-B, USB 2.0 (Hi-Speed USB)

### Power/Others

- **Power supply (rated)**  
7.4 V DC (battery pack), 8.4 V DC (DC IN)
- **Power consumption (Recording at 50 Mbps with AF on, viewfinder/LCD screen normal brightness, SDI output off)**  
**XF105** Viewfinder: 6.1 W, LCD screen: 6.2 W  
**XF100** Viewfinder: 5.1 W, LCD screen: 5.2 W
- **Operating temperature**  
0 – 40 °C
- **Dimensions (W x H x D)**  
121 x 148 x 250 mm (excluding lens hood, microphone holder unit, grip belt)
- **Weight (camcorder body only)**  
**XF105** 1,070 g **XF100** 1,020 g

### CA-930 Compact Power Adapter

- **Rated input**  
100 – 240 V AC, 50/60 Hz  
As a power adapter: 46 VA (100 V) – 62 VA (240 V)  
As a battery charger: 40 VA (100 V) – 54 VA (240 V)
- **Rated output**  
As a power adapter: 8.4 V DC, 2.4 A  
As a battery charger: 8.4 V DC, 1.5/2.0 A
- **Operating temperature**  
0 – 40 °C
- **Dimensions (W x H x D)**  
85 x 51 x 110 mm
- **Weight**  
240 g



## BP-925 Battery Pack

- **Battery type**  
Rechargeable lithium ion battery, compatible with Intelligent System
- **Rated voltage**  
7.4 V DC
- **Operating temperature**  
0 – 40 °C
- **Battery capacity**  
Typical: 2,600 mAh  
Minimum: 19 Wh / 2,450 mAh
- **Dimensions (W x H x D)**  
38.2 x 43.5 x 70.5 mm
- **Weight**  
130 g

Weight and dimensions are approximate. Errors and omissions excepted.  
The information in this manual is verified as of October 2014. Subject to change without notice.

<b>A</b>	
Abroad, using the camcorder	165
Accessories	166
AE level	58
AGC	53
AGC limit	53
Aperture	57
Aspect ratio	122
Assignable buttons	94
Audio output	126
Audio peak limiter	142
Audio recording	74
Audio recording level	77
Audio reference signal	80
Auto white balance	59
AV terminal	125
<b>B</b>	
Battery pack	21
Bit rate	45
Built-in backup battery	164
<b>C</b>	
Camera settings	106
CF card	
Inserting	34
Recording method	37
Recovering data	38
Removing	35
Check marks (☑)	115
Clips	
Adding an  mark/☑ mark	115
Adding/Deleting shot marks	83, 112, 119
Copying	116
Deleting	117
Displaying clip information	114
Playback	109
Color bars	80
Condensation	165
Connection to an external monitor	123
Conversion lens	66
CUSTOM button/dial	46
Custom displays	105
Custom functions	104
Custom picture	96
Custom picture settings	99
<b>D</b>	
Date and time	25
Date format	146
DC IN terminal	23
<b>E</b>	
Edge monitor	82
Embedded audio*	126
<b>F</b>	
Flicker reduction	56
Focal length guide	93
Focus	47
Focus limit	51
Frame rate	45
Frame recording mode	86
Free-run (time code)	69
Full auto mode	41
<b>G</b>	
Gain	53
Genlock	72
GENLOCK/TC terminal*	72
Grip belt	31
<b>H</b>	
HD/SD COMPONENT OUT terminal	124
HD/SD SDI terminal*	124
HDMI OUT terminal	124
Headphone terminal	78
Hour meter	149
<b>I</b>	
Image stabilizer	52
Index screens	
Changing clip thumbnail	120
Clips	107
Expand clip	119
Shot marks	118
Infrared recording	90
Initializing recording media	36
Interval recording mode	85
Iris	57

Iris limit .....57

## L

Language .....26

LCD panel .....30

LCD screen .....30

Lens hood .....29

Light metering .....58

## M

Macro shooting .....51

Menu settings .....139

Message list .....159

Metadata .....79

Microphone .....74, 75

Microphone attenuator .....75, 77

Microphone holder unit .....29

Microphone sensitivity .....75, 76

Monitoring audio .....78

MXF file type .....4

## O

OK marks (OK) .....115

Onscreen markers .....67

Optical axis shift .....92

## P

Peaking .....48

Phantom power (microphone) .....76

Photos  
     Copying custom picture files .....137  
     Deleting .....135  
     Protecting .....136  
     Viewing .....134

Playback  
     Clips .....109  
     Photos .....134

Power save mode .....44

Power supply .....21

POWER switch .....24

Pre-recording mode .....88

## R

Rec run (time code) .....69

Recording clips .....39

Remaining battery ..... 22

REMOTE terminal ..... 65

Resetting all settings ..... 146

Resolution (frame size) ..... 45

Reviewing a recording ..... 84

Running mode (time code) ..... 69

## S

Safety zone ..... 67

Saving clips to a computer ..... 128

SD card ..... 36

Shooting frame rate ..... 87

Shot marks ..... 83, 112

Shutter speed ..... 55

Slow & fast motion recording mode ..... 87

Specifications ..... 170

Status screens ..... 150

Switching CF card slots ..... 37

## T

Taking photos ..... 132

Tally lamp ..... 146

Terminal covers ..... 32

Time code ..... 69, 72

Tripod ..... 33, 162

Troubleshooting ..... 156

Turning the camcorder on/off ..... 24

## U

USB terminal ..... 19

User bit ..... 71

User memo ..... 79

## V

Video configuration ..... 45

Video output configuration ..... 121

Viewfinder ..... 30

## W

Waveform monitor ..... 81

White balance ..... 59

Wireless controller ..... 20

## X

XLR terminals ..... 74

**Z**

Zebra pattern .....68  
Zoom .....62  
Zoom rockers .....62



Canon Inc. 30-2, Shimomaruko 3-chome, Ohta-ku, Tokyo 146-8501, Japan  
Canon Europa N.V. Bovenkerkerweg 59, 1185 XB Amstelveen, The Netherlands <http://www.canon-europe.com>

---

**ASIA and HONG KONG, S.A.R.**

Canon Hongkong Company Ltd  
19/F, The Metropolis Tower, 10 Metropolis Drive,  
Hungghom, Kowloon, Hong Kong  
☎ +852 3191 2333, 📠 +852 2428 3963

**AUSTRALIA** <http://www.canon.com.au>

Canon Australia Pty Ltd  
☎ 13-13-83 (within Australia only)  
☎ (61) 02-9805-2555

**CENTRO Y SURAMÉRICA** <http://www.cla.canon.com>

CANON LATIN AMERICA, INC.

**NEW ZEALAND** <http://www.canon.co.nz>

Canon New Zealand Ltd  
☎ 0800-222-666 (within New Zealand only)  
☎ (64) 09-489-0300

**SINGAPORE**

Canon Singapore Pte. Ltd  
1 HarbourFront Avenue, #04-01 Keppel Bay Tower,  
Singapore 098632  
☎ (65) 6799 8888, 📠 (65) 6799 8882

**UNITED KINGDOM**

Canon UK Ltd  
CCI Service Centre, Unit 130, Centennial Park,  
Borehamwood, Hertfordshire, WD6 3SE  
☎ 0844-369-0100

---

Visit your local Canon Web site to download the latest version of this Instruction Manual.

